

*Safeguards and Security  
Research and Development  
Progress Report*

*October 1994 to September 1995*

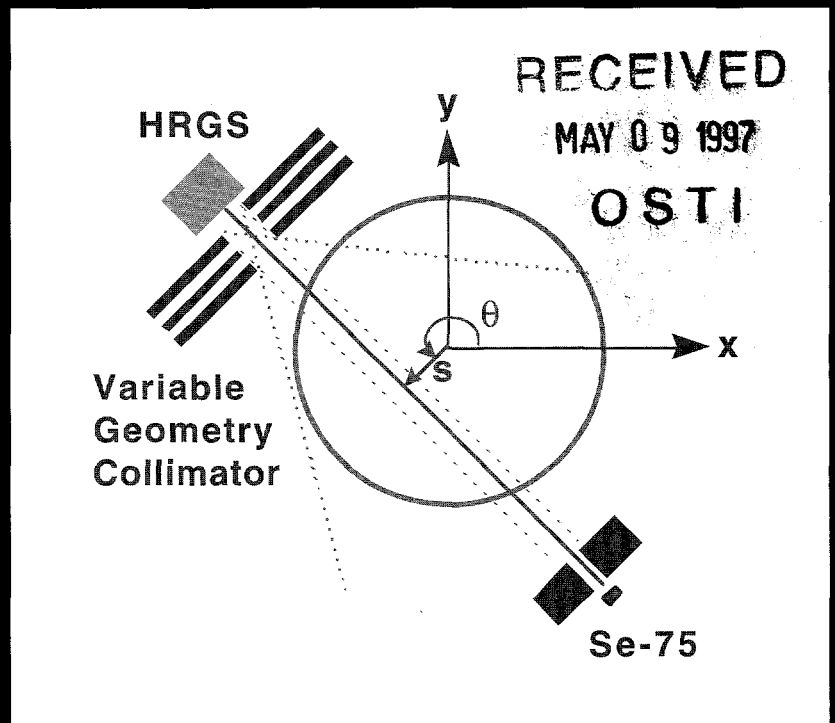

**Los Alamos**  
NATIONAL LABORATORY

*Los Alamos National Laboratory is operated by the University of California  
for the United States Department of Energy under contract W-7405-ENG-36.*

*Edited by Paul W. Henriksen, Group CIC-1*

*Photocomposition by Belinda K. Haag, Group CIC-1*

*This work was supported by the US Department of Energy,  
Office of Safeguards and Security.*

*The four most recent reports in this series, unclassified, are  
LA-12953-PR, LA-12816-PR, LA-12544-PR, and  
LA-12334-PR.*

*An Affirmative Action/Equal Opportunity Employer*

*Front Cover Illustration:*

*This schematic drawing illustrates the basic layout of the tomographic gamma-ray scanning (TGS) system. A high-resolution gamma-ray spectroscopy system measures the intensity of gamma rays from a selenium-75 source as they penetrate each part of a waste drum and the intensity of gamma rays from material within the drum. By comparing the signals, the TGS can show the location and quantity of gamma-ray emitting material inside the drum. For a more detailed description of the TGS, see the article beginning on page 32.*

*This report was prepared as an account of work sponsored by an agency of the United States Government. Neither The Regents of the University of California, the United States Government nor any agency thereof, nor any of their employees, makes any warranty, express or implied, or assumes any legal liability or responsibility for the accuracy, completeness, or usefulness of any information, apparatus, product, or process disclosed, or represents that its use would not infringe privately owned rights. Reference herein to any specific commercial product, process, or service by trade name, trademark, manufacturer, or otherwise, does not necessarily constitute or imply its endorsement, recommendation, or favoring by The Regents of the University of California, the United States Government, or any agency thereof. The views and opinions of authors expressed herein do not necessarily state or reflect those of The Regents of the University of California, the United States Government, or any agency thereof. Los Alamos National Laboratory strongly supports academic freedom and a researcher's right to publish; as an institution, however, the Laboratory does not endorse the viewpoint of a publication or guarantee its technical correctness.*

*Safeguards and Security  
Research and Development  
Progress Report*

*October 1994 to September 1995*

*Compiled by  
Debra R. Rutherford  
Paul W. Henriksen*

**MASTER**

DISTRIBUTION OF THIS DOCUMENT IS UNLIMITED

**Los Alamos**  
NATIONAL LABORATORY

Los Alamos, New Mexico 87545

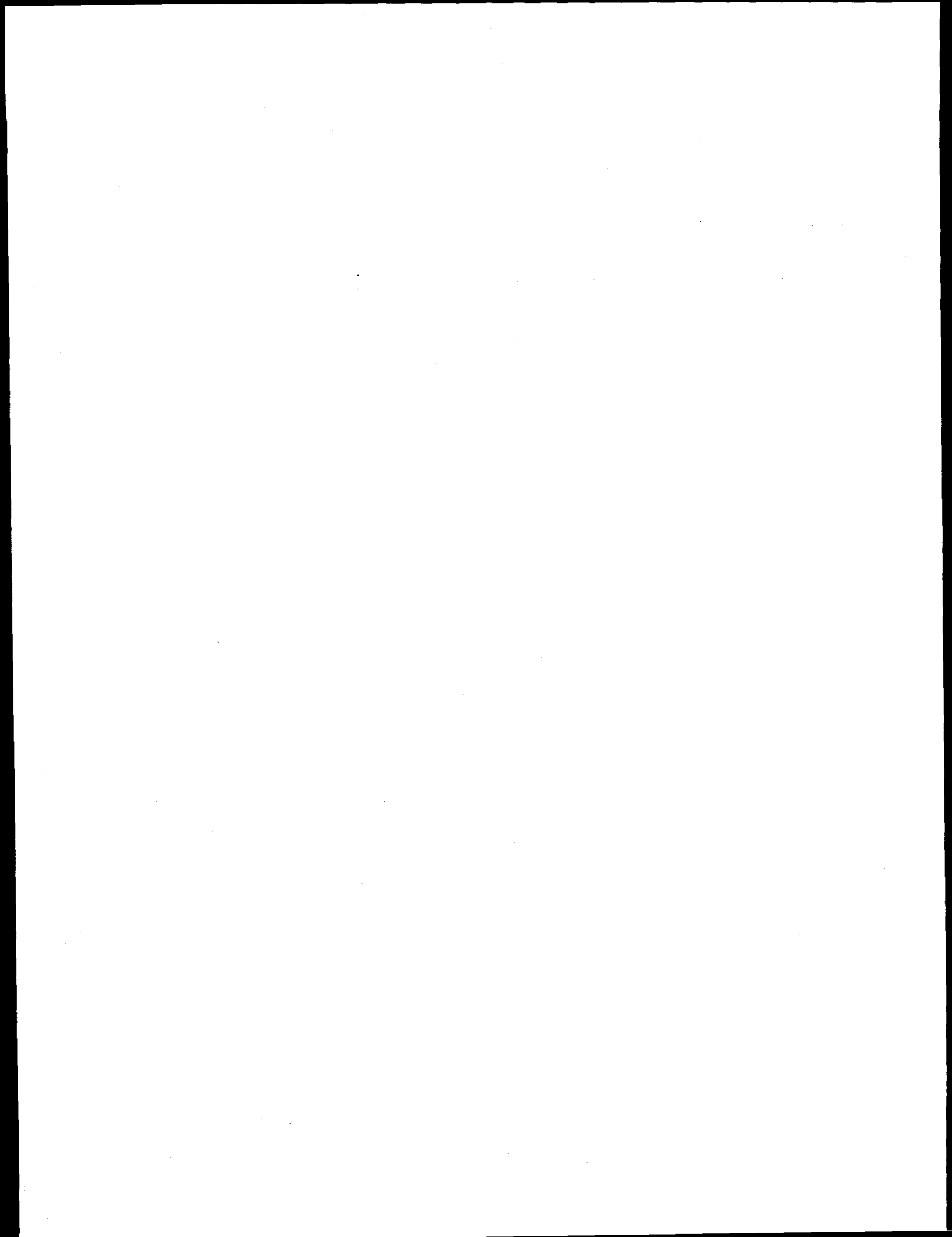



**DISCLAIMER**

**Portions of this document may be illegible in electronic image products. Images are produced from the best available original document.**

## TABLE OF CONTENTS

<b>Abstract</b> .....	1
<b>Acronyms and Initialisms</b> .....	2
<b>Part I. Nuclear Material Measurement Systems</b> .....	3
Hybrid KED/KXRF Densitometer: Simulation and Application .....	5
Shipper Receiver Confirmatory System (S/RCS) for Highly Enriched Uranium (HEU) .....	7
Vault Inventory Monitor Project .....	7
Waste Measurements: Support to DOE Facilities .....	7
Active Neutron Multiplicity Counting .....	7
Small Sample and Standards Characterization with NDA .....	8
Weapons Isotopic Analysis with the Fixed Energy Response Function Analysis with Multiple Efficiencies (FRAM) Code .....	9
Automated Weapons Dismantlement NDA System .....	12
Active/Passive Multiplicity Analysis of Weapons Components and Process Materials .....	12
Room-Temperature Gamma-Ray Detectors for Nonproliferation and International and Domestic Safeguards .....	14
NDA Consensus Standards Development for the American Society for Testing and Materials (ASTM) Subcommittee C26.10 .....	18
Consensus Standards Support for the American Society for Testing and Materials (ASTM) Subcommittee C26.12 ..	18
Dissemination of Technology Information in Support of SNM Portal Monitoring .....	19
Updated Vehicle SNM Monitor Applications Guide .....	19
Combined Thermal/ Epithermal Neutron (CTEN)/Tomographic Gamma Scanner (TGS) Package Monitor .....	20
Implementation of Neutron Counting Techniques at U.S. Facilities for IAEA Verification of Excess Materials from Nuclear Weapons Production .....	20
Performance Demonstration Program (PDD) for Waste Isolation Pilot Plant (WIPP) .....	21
Add-A-Source Lifecycle Technology Transfer in Support of Cooperative Research and Development Agreement (CRADA) Activities .....	25
Combined Neutron Gamma Lifecycle .....	26
Integrated SGS/Isotopics/Peak Search & ID .....	26
NDA Technology Exchange and Implementation .....	27
Field Test and Evaluation of Tomographic Gamma Scanning .....	29
Tomographic Gamma Scanning: Overview .....	32
MC&A Technology Training .....	34
Los Alamos/DOE Safeguards Technology/Training Program .....	35
MC&A Training Support to the CTA .....	35
Evaluation of the Integrated Hold-up Measurement System with the M <sup>3</sup> CA for Assay of Uranium Holdup .....	35
Quantitative Verification of In-Process Inventory of High-Burnup Plutonium Using Room-Temperature Gamma-Ray Detectors and the GGH Formalism .....	37
Assessment of NDA Requirements for Measurements of Rocky Flats Residues .....	46
Add-A-Source Waste Drum Assay System .....	51
WIN_TGS Software for Tomographic Assay Systems .....	53
Acoustic Resonance Spectroscopy to Localize Holdup .....	55
Acoustic Resonance Spectroscopy with Intrinsic Seals .....	55
Non-Sensitive Attribute Measurements for Weapons Components .....	56
Safety Documentation and Analysis for Safeguards Technology Development .....	59
<b>Part II. Integrated Safeguards Systems</b> .....	65
Improved Variance Propagation .....	65
LANMAS Development .....	65
LANMAS Implementation .....	66
Technical Assistance to DOE Headquarters .....	66
Policy and Technical Issues for Adapting DOE Safeguards to International Inspections .....	67

## TABLE OF CONTENTS (CONTINUED)

Guidance Manual for Nuclear Material Categorization .....	68
Seminar on Materials Accounting for Nuclear Safeguards .....	68
Automated Anomaly Detection .....	68
Automated MC&A Database Assessment .....	69
Data Analysis/Anomaly Detection Software Toolkit for Analysis Research (STAR) .....	72
<b>Part III. Systems Effectiveness Evaluation .....</b>	<b>75</b>
Shuffler Assay Accuracy: Improvements .....	75
<b>Part IV. Information Assurance .....</b>	<b>77</b>
Independent Validation and Verification and Tripwire Projects .....	77
Nuclear Materials Control and Accounting (MC&A) Measures for Safeguards at the Plutonium Fuel Production Facility (PFPP) at Tokai .....	78
Expanded Nunn-Lugar Materials Protection Control and Accounting (MPC&A) Program in Russia .....	78
<b>Part V. International Safeguards .....</b>	<b>81</b>
Simulation of the Integrated Materials Examination Facility .....	81
Modification and/or Extension of NRTA Simulation Techniques .....	81
Simulation of a Representative Reprocessing Plant .....	81
Safeguards Analysis for Accelerator-Based Conversion .....	82
Global Nuclear Material Monitoring .....	82
Global Nuclear Material Flow Model .....	83
IAEA Inspector Training Course .....	84
Active Well Coincidence Counter (AWCC) for Nuclear Material Verification Measurements at the Obninsk IPPE BFS-1 and BFS-2 Facility .....	84
Kazakhstan .....	88
U.S. Assistance for Russian National MC&A .....	88
Feasibility Study of Plutonium and Uranium Measurement in Input Dissolver Solutions .....	90
Prototype Development of Isotopic Dilution Gamma-ray Spectrometry .....	91
Laboratory to Laboratory Materials Protection, Control, and Accounting Program .....	92
<b>Abstracts and Presentations .....</b>	<b>97</b>

# **SAFEGUARDS AND SECURITY RESEARCH AND DEVELOPMENT PROGRESS REPORT**

October 1994 to September 1995

Compiled by  
Debra R. Rutherford and Paul W. Henriksen

## **ABSTRACT**

The primary goal of the Los Alamos Safeguards and Security Technology Development Program, International Safeguards, and other Safeguards and Security Programs is to continue to be the center of excellence in the field of Safeguards and Security. This annual report for 1995 describes these scientific and engineering projects that contribute to all of the aforementioned programs. We have presented the information in a different format from previous annual reports. Part I is devoted to Nuclear Material Measurement Systems. Part II contains projects that are specific to Integrated Safeguards Systems. Part III highlights Safeguards Systems Effectiveness Evaluations and Part IV is a compilation of highlights from Information Assurance projects. Finally Part V highlights work on the projects at Los Alamos for International Safeguards. The final part of this annual report lists titles and abstracts of Los Alamos Safeguards and Security Technology Development reports, technical journal articles, and conference papers that were presented and published in 1995.

Part I highlights all project phases for the Nuclear Materials Measurement Systems. These phases are basic science and technology development, concept and demonstration, and finally full-scale development. An example of these phases is the tomographic gamma-ray scanner.

Technology transfer is often highlighted in all parts of this report. The topic includes not only the conventional transfer to industry, i.e., pedestrian and vehicle portal monitors, but also vital transfer of information to the Department of Energy and its contractors. An example of this is consultation on nuclear materials management, control, and accounting challenges and opportunities. DOE contractors like Westinghouse Savannah River Site participate in the development and demonstration of specialized techniques and instruments as well as comprehensive advanced safeguards systems. Another critical aspect of the transfer of these advanced technologies is the successful training program for those who use these technologies.

Part V of this report delineates the symbiotic relationship between international safeguards and U.S. domestic safeguards.

This is the last annual report in this format. We wish to thank all of the individuals who have contributed to this annual report and made it so successful over the years.

## ACRONYMS AND INITIALISMS

3RMC	3-ring Multiplicity Counter	IDGS	isotope dilution gamma-ray spectrometry
ABC	accelerator-based conversion	IDMS	isotope dilution mass spectrometry
ACE	alternating conditional expectation	IMEF	Integrated Materials Examination Facility
ANL-West	Argonne National Laboratory West	INEL	Idaho National Engineering Laboratory
ARIES	Advanced Recovery and Integrated Extraction System	INMM	Institute for Nuclear Materials Management
ARS	acoustic resonance spectroscopy	IPIV	Initial Physical Inventory Verification
ASTM	American Society for Testing and Materials	IPPE	Institute of Physics and Power Engineering
ATR	Advanced Test Reactor	IV&V	independent validation and verification
AWCC	Active Well Coincidence Counter	INFL	Japan Nuclear Fuels Limited
BIO	Basis for Interim Operations	KAERI	Korean Atomic Energy Research Institute
BIR	Baseline Inventory Report	KED	K-edge densitometry
BNL	Brookhaven National Laboratory	LANMAS	Local Area Network Material Accountability System
CANDU	Canadian depleted uranium	LBL	Lawrence Berkeley Laboratory
CEA	Commissariat a l'energie atomique	LBU	low burnup
CG	conjugate gradient	LEU	low-enriched uranium
CISA	Center for International Security Affairs	LLNL	Lawrence Livermore National Laboratory
CRADA	Cooperative Research and Development Agreement	LLW	low-level waste
CT	computerized tomography	MABSIM	Materials Accounting by Simulation
CTA	Central Training Academy	MASS	Material Accountability and Safeguards System
CTEN	Combined Thermal/Epithermal Neutron	MAWST	Materials Accounting with Sequential Testing
DA	destructive analysis	MB	material balance
DE	diatomaceous earth	MCA	Multichannel Analyzer
DLL	dynamic link library	M <sup>3</sup> CA	Miniature Modular Multichannel Analyzer
DNA	Defense Nuclear Agency	MC&A	materials control and accountability
DQO	data quality objectives	MCB	Multichannel Buffer
DUPIC	depleted uranium produced in CANDU reactors	MCNP	Monte Carlo Neutron Photon
EMAT	electromagnetic acoustic transducers	MCRS	medium-count-rate system
FACSIM	Facility Simulation	MOX	mixed oxide
FAM	fuzzy associative memory	MPC&A	materials protection control and accounting
FGE	fissile gram equivalent	MUF	material unaccounted for
FOM	figure of merit	NCC	neutron coincidence counting
FRAM	Fixed energy Response function Analysis with Multiple efficiencies	NDA	nondestructive assay
FSU	former Soviet Union	NDE	nondestructive evaluation
FWHM	full-width at half-maximum	NMMSS	Nuclear Material Management and Safeguards System
GAO	General Accounting Office	NRC	Nuclear Regulatory Commission
GGH	generalized geometry holdup	NRTA	near-real-time accounting
GUI	graphical user interface	NSA	National Security Agency
HBU	high burnup	OSS	Office of Safeguards and Security
HCRS	high-count-rate system	PAFD	process accounting flow diagrams
HEU	highly enriched uranium	PATRM	Pulse Arrival Time Recording Module
HLNC	High-Level Neutron Coincidence Counter	PC	personal computer
HMSII	Hold-up Measurement System II	PCG	Permanent Coordinating Group
HPGe	high-purity germanium	PDP	performance demonstration program
HRGS	high-resolution gamma-ray spectroscopy	PE	polyethylene
HVAC	heating, ventilating, and air conditioning	PFP	Plutonium Finishing Plant
IAEA	International Atomic Energy Agency	PFPF	Plutonium Fuel Production Facility
ICN	Integrated Computing Network	PIT	Process Improvement Team
ICP	inductively coupled plasma	PIV	Physical Inventory Verification
IDC	item description code	PLC	programmable logic controller
		PMCA	portable multichannel analyzer

PNC	Plutonium Nuclear Fuels Corporation	SRS	Savannah River Site
PNL	Pacific Northwest Laboratory	SSIMS	Safeguards and Security Information Management System
PNMC	plutonium neutron multiplicity counter	STAR	Software Toolkit for Analysis Research
PP	physical protection	T&E	test and evaluation
PSR	portable shift register	TCNDA	transmission corrected gamma-ray nondestructive assay
PWR	pressurized-water reactor	TGS	tomographic gamma-ray system
QAPP	Quality Assurance Program Plan	TRU	transuranic
QA/QC	quality assurance/quality control	TWG	Technical Working Group
R&D	research and development	UNCL	uranium neutron coincidence collar
RFETS	Rocky Flats Environmental Technology Site	VP	variance propagation
ROI	region of interest	VTRAP	Video Time Radiation Analysis Program
RR	radial response	WAC	waste acceptance criteria
RRP	Rokkasho-Mura Reprocessing Plant	WG	weapons grade
SABRS	Space and Atmospheric Burst Reporting System	WHC	Westinghouse Hanford Corporation
SAR	safety analysis report	WSRC	Westinghouse Savannah River Company
SGS	segmented gamma-ray scanner	XRF	x-ray fluorescence
SNM	special nuclear material	WIPP	Waste Isolation Pilot Plant
SNMP	simple network management protocol		
S/RCS	shipper/receiver confirmatory system		

**Note to Reader:**

All company names, logos, and products mentioned herein are registered trademarks of their respective companies. Reference to any specific company or product is not to be construed as an endorsement of said company or product by the Regents of the University of California, the United States Government, the U.S. Department of Energy, nor any of their employees.



*Part I.*

*Nuclear Material Measurement Systems*



## PART I. NUCLEAR MATERIAL MEASUREMENT SYSTEMS

**Hybrid KED/KXRF Densitometer: Simulation and Application (S.-T. Hsue and Michael Collins, NIS-5).**

The Hybrid K-Edge/K-XRF Densitometer is a unique nondestructive assay (NDA) instrument for determining the concentrations of the special nuclear material (SNM) in solutions. The technique is ideally suited to assay the dissolver solutions as well as the uranium and plutonium product solutions from reprocessing plants. It is an important instrument for safeguarding reprocessing plants; it is also a useful tool in analytical laboratories because it can analyze mixed solutions of SNM without chemical separation.

The Hybrid Densitometer combines two complementary assay techniques: absorption K-edge densitometry (KED) and x-ray fluorescence (XRF).<sup>1</sup> KED measures the transmission of a tightly collimated photon beam through the sample; it is therefore quite insensitive to radiation emitted by the sample material. Fission product levels of ~1 Ci/ml can be tolerated. The technique is insensitive to matrix variations. XRF measures the fluorescent x-rays from the same sample and can be used to determine the ratios of SNM. The technique can be applied to determining the concentrations of thorium, uranium, neptunium, plutonium, and americium. The technique can also be applied to mixed solutions found in the nuclear fuel cycle without separation: thorium-uranium, uranium-plutonium, and neptunium-plutonium-amer-icium.

**Densitometry Simulation**

There are at least two different ways to simulate the densitometry process. For example, a Monte Carlo particle-transport method could be used to generate a simulated spectrum. However, because we strive for at least 0.01% or better precision in the calculations, the required computing time would be prohibitively long.

The other simulation alternative is to start with the reference spectrum.<sup>2</sup> This spectrum is obtained from the densitometer by using a sample vial that contains only the nominal matrix solution. Because this spectrum was taken with the actual densitometer system, all the multiple scattering events are taken into account and measured by the detector. The difference between the sample solution and the reference solution is due, therefore, to the presence of SNM. To generate the simulated spectrum for the SNM solution, we need to attenuate the net reference spectrum, channel by channel, according to the following equation:

$$I(E) = I_0(E) \cdot \sum_{i=1}^j \exp(-\mu_i(E) \cdot \rho_i \cdot x) \quad (1)$$

where  $E$  is the energy corresponding to a channel,  $i$  is the SNM element index,  $j$  is the number of SNM elements in the solution,  $\mu_i$  is the mass absorption coefficient of element  $i$  at energy  $E$ ,  $\rho_i$  is the known density of element  $i$  in the solution, and  $x$  is the thickness of the solution.

Figure 1 shows the simulated spectrum, using this method, for a solution that contains 200 g/l of uranium. The

lower curve in Fig. 1 shows the spectrum measured with an actual 208 g/l solution. The two curves are quite similar. The only exception is that near the absorption edge, where the simulated spectrum shows a sharp discontinuity, the actual spectrum is more "rounded." This difference is a result of the finite resolution of the detector, which tends to distribute some counts near the edge into neighboring channels. This difference does not affect the analysis because data near the edge is not used.

**XRF Simulation**

To simulate the XRF process, we also start with the reference spectrum. This is the spectrum obtained from the XRF detector by using a sample vial that contains only the nominal matrix solution. Because this spectrum was taken with the actual densitometer system, all the multiple scattering events in the matrix are taken into account and measured by the detector. The difference between the sample solution and the reference solution is caused, therefore, by the presence of SNM. We see the difference by superimposing the x-ray peaks from the particular SNM and the concentration of the SNM on

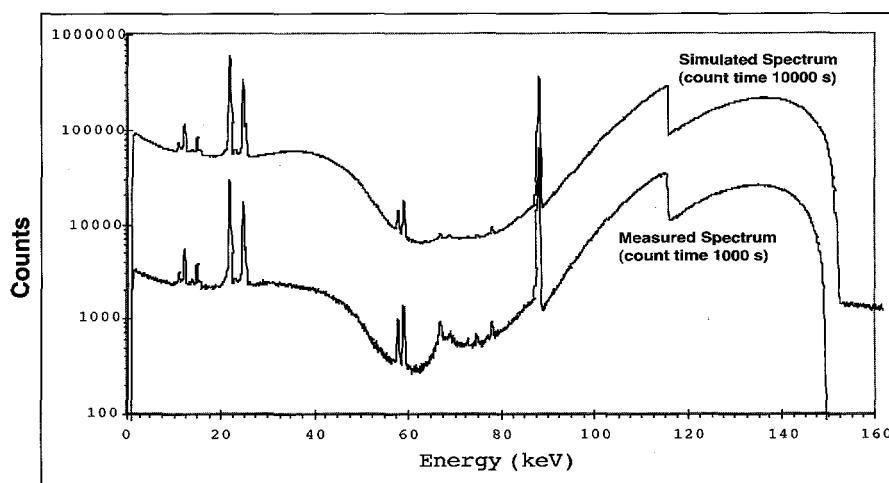

Fig. 1. Simulated densitometry spectrum of 200 g/l uranium solution and measured spectrum.

the reference spectrum in the following way. As the continuous x-ray beam penetrates into the solution, the portion of the beam above the K-edge of the SNM can excite an x-ray from the SNM. Because we know the concentration of the SNM, we can calculate the excitation as well as attenuation of the x-rays through the solution. The calculation must be summed from the K-edge to the end point of the continuous x-ray beam. We also have to take into account the relative efficiency of the detector in this energy range. A simulation of a spectrum from a mixed solution of uranium and plutonium (200 gU/l, 2 gPu/l) is shown in Fig. 2.

### Application of Simulation

Computers can simulate SNM solutions that are hard or expensive to prepare. The following is an application of the simulation codes.

Assume we have a uranium and plutonium mixed solution; assume that the uranium concentration is 200 g/l and the plutonium concentration can vary from 2 g/l to 100 g/l. There are three methods to determine the uranium and plutonium concentrations: (1) dual element densitometry analysis,<sup>3</sup> (2) densitometry analysis of a single element with known ratio,<sup>2,4</sup> and (3) combined XRF and densitometry hybrid analysis. The dual-element method utilizes data from three fitting windows: a 6-keV-wide region below the lower K-edge, a 2-keV-wide region located between the two K-edges, and a 6-keV-wide region above the upper K-edge. The *known ratio analysis technique* is the new technique we developed and is based upon the following. If we knew the concentrations of all the minor elements and their mass attenuation coefficients, we could mathematically "de-attenuate" their effects from the original spectrum. After the de-attenuation, the concentration of the major and minor SNM components can be determined by the single-element method. In the hybrid analysis, the XRF determines the ratios of the SNM and

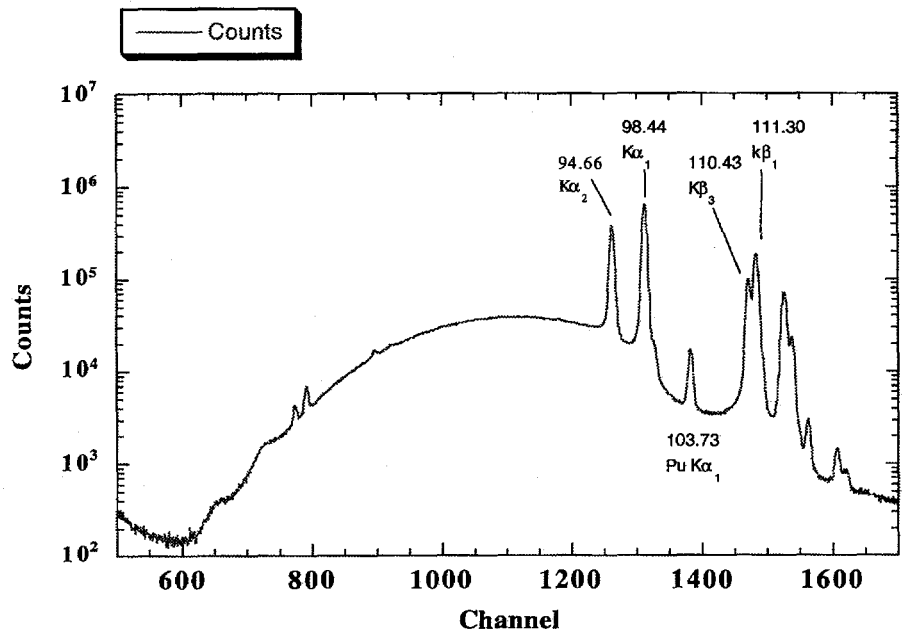

Fig. 2. Simulated XRF spectrum of a solution of 200 g/l uranium and 2 g/l plutonium.

densitometry determines the concentration of the major SNM component.

Table I shows the precision of all three analysis methods. The precision is that of plutonium determination; all assay times have been normalized to 1000 s.

Figure 3 shows the comparison of the three methods of analysis.

In this figure, the precision of the single-element known ratio analysis is in general a factor of 4 better than that of dual-element analysis. The hybrid

analysis (XRF + DEN) is the most precise; at low concentrations its precision is improved by almost a factor of 10 compared to the single-element known-ratio analysis.

This application shows that simulation codes can be used to estimate the measurement precision of the Hybrid Densitometer for various mixed solutions. In the future we will use the codes to simulate more SNM combinations, enhancing the versatility and precision of the Hybrid Densitometer.

TABLE I. Comparison of Precisions from Plutonium Dual-Element, Single-Element, and Hybrid Analyses

U (g/l)	Pu (g/l)	Plutonium Dual-Element Analysis (%)	Plutonium Single-Element Known Ratio Analysis (%)	Plutonium Hybrid Analysis (%)
200	2	40.67	12.08	0.90
200	5	16.35	4.87	0.49
200	10	8.25	2.47	0.35
200	20	4.21	1.26	0.29
200	40	2.18	0.66	0.27
200	60	1.50	0.47	0.26
200	100	0.97	0.32	0.25

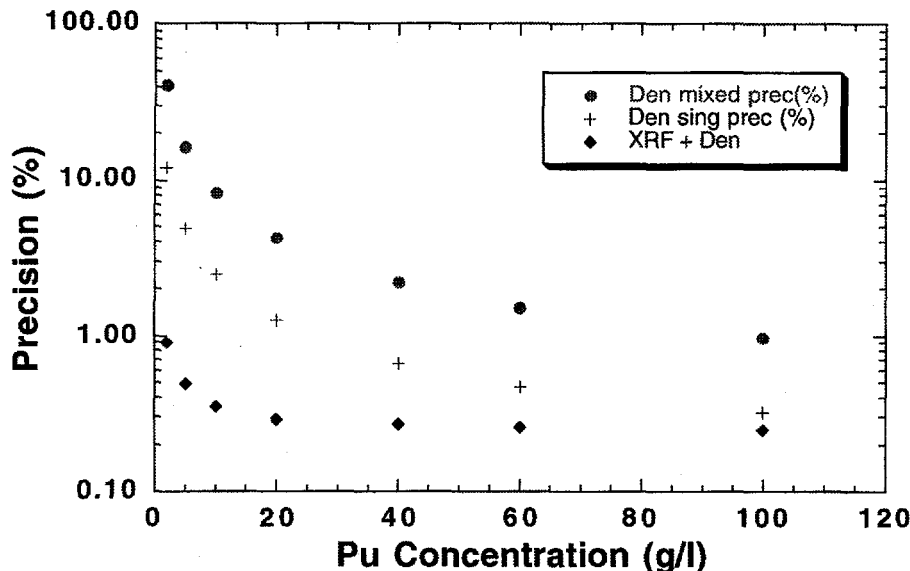

Fig. 3. Precision of three analysis methods using data from hybrid densitometry. The uranium concentration is assumed to be 200 g/l; the plutonium concentrations vary from 2 g/l to 100 g/l.

**Shipper Receiver Confirmatory System (S/RCS) for Highly Enriched Uranium (HEU)** (J. K. Sprinkle, Jr., R. Williams, J. Martinez, C. Garcia, and L. Trujillo, NIS-5). U.S. Department of Energy (DOE) orders require confirmation measurements for shipments between nuclear facilities when accountability measurements are not feasible. The accountability measurements are of better quality, but they are not always financially or technically possible. The issue of concern is whether all the SNM that left Facility A arrived at Facility B. Confirmatory measurements give a high assurance that the SNM arrived, without a precise quantitative result. DOE orders also mention confirmation measurements in the context of periodic inventory verification, when they are applied to difficult-to-measure items in lieu of accountability measurements. We continued to assist DOE and the Los Alamos storage facilities in determining a single definition of confirmatory measurements that would be acceptable in both contexts. A definition that can be applied to low-enriched uranium (LEU), HEU, and plutonium is to measure two attributes clearly above background. Heat, neutrons, gamma rays of

specific energies, and alpha particles are possible signals. Specifically, LEU and HEU can be distinguished by comparing the intensities of different gamma rays because gamma rays are the only useful passive signature.

**Vault Inventory Monitor Project** (J. K. Sprinkle Jr., R. Siebelist, P. A. Russo, J. K. Halbig, S. Klosterbuer, G. Wiig, and M. M. Stephens, NIS-5). Nuclear material storage facilities periodically inventory their SNM. These audits are required by DOE orders that specify activities such as documentation reviews, verification of tamper indicating devices, and remeasurement of items. Some of these activities require access to the nuclear material and entry into the storage facility. Exposure to significant doses of radiation is possible in some storage facilities. Access to storage facilities can be expensive, due to the requirements to have guards, health physics monitors, custodians, auditors (and supervisors for most of the previous) present while the storage facility is open. We are working with the local DOE office, the Los Alamos internal oversight organization, the facility, and the auditors to develop instruments and procedures to reduce

cost and radiation exposure while improving the quality of the measurements used in inventory verification.

We observed some inventory verifications this year and discussed the procedures with the participants. We have also applied some innovative measurement ideas to unmeasured inventory and discussed the pros and cons of such measurements with various participants. There is a definite need for automation and easy-to-use instruments in the poor working environment often found in nuclear material storage facilities. We plan to develop hardened instrumentation and robust software and test it in the coming year.

**Waste Measurements: Support to DOE Facilities** (J. K. Sprinkle, Jr., M. Pickrell, N. Ensslin, and P. A. Russo, NIS-5). We consult with the Oak Ridge Y-12 facility as they design and construct their new waste management facility. They plan to develop an integrated system that will measure all of the facility's waste streams and archive the results. A central location will perform all measurements, thus providing a consistent plant-wide capability. Our role is to provide an independent assessment of their progress, to assist with long-range planning, to help identify shortcomings before they become showstoppers, and to provide technical help with measurement difficulties if and when they arise.

**Active Neutron Multiplicity Counting** (Merlyn S. Krick, NIS-5). Passive neutron multiplicity counting has become a standard NDA technique for the assay of impure plutonium samples. The advantage of the technique is that it can determine plutonium masses for samples without a calibration curve and thus can assay plutonium samples with unknown impurities.

Active coincidence counting is a standard technique for the assay of uranium. Each material type requires its own calibration curve, but a suitable calibration curve may not exist for the material to be measured. One of our

goals for active multiplicity counting is to assay uranium samples with assorted masses, densities, and geometries without the need for calibration curves for each material type.

In active coincidence or multiplicity counting, fissions are induced in  $^{235}\text{U}$  by neutrons from AmLi sources. A quantity called the "coupling" is the number of primary  $^{235}\text{U}$  fissions induced per AmLi neutron per gram of  $^{235}\text{U}$ . The coupling depends on the type of sample and the configuration of the neutron detector. In the active multiplicity equations, the coupling always appears in this product: coupling times  $^{235}\text{U}$  mass. Thus the multiplicity equations cannot determine the coupling, and the  $^{235}\text{U}$  mass cannot be determined until the coupling is known.

We have found from experiments and Monte Carlo calculations that there is a close relationship between coupling and neutron multiplication. The measured relationship between coupling and multiplication is shown in Fig. 4 for three types of uranium samples: pure uranium oxide with several enrichments, impure enriched uranium oxide (skull oxide from the Y-12 plant), and pure high-enrichment uranium metal. The neutron multiplication in a sample can be determined from the triples/doubles count rate ratio obtained from active multiplicity measurements. Thus the coupling-multiplication relationship might provide a method for assaying arbitrary uranium samples for which assay calibration curves are not available. We are continuing our study of the relationship between coupling and multiplication.

### Neutron Coincidence Counting (NCC) Software

We are developing a general-purpose neutron coincidence counting program called NCC for personal computers running Windows. Our goal is to produce a neutron coincidence counting program that includes—in one package—all of the common passive and active coincidence counting techniques.

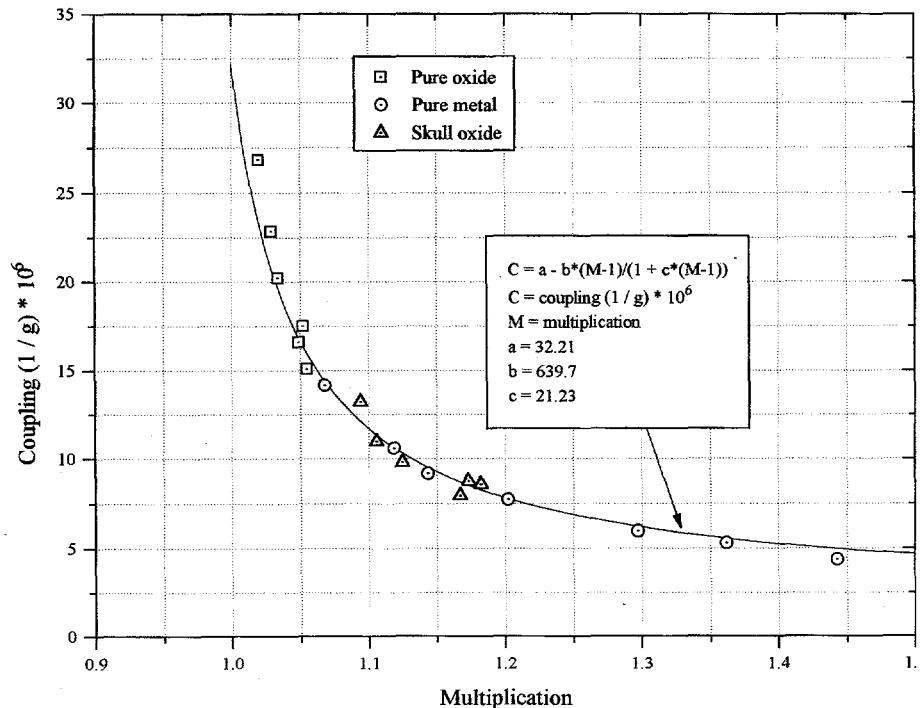

Fig. 4. Measured relationship between coupling and multiplication for pure uranium oxide, impure enriched uranium oxide, and pure, highly enriched uranium metal.

We are planning a formal release of the code in May 1996.

The program can assay plutonium using the following techniques: calibration curve, known-alpha multiplication correction, known-multiplication analysis, multiplicity analysis, add-a-source correction, and active/passive analysis. It can perform uranium assays using the calibration-curve technique and can determine neutron multiplication in uranium samples using the active multiplicity technique. Some of these techniques can be used for mixed-oxide (MOX) samples also.

The Deming least-squares curve-fitting program has been linked to the NCC program, so that calibration measurements, curve-fitting, and assays can be performed without leaving the NCC program. Calibration curves can be displayed and printed with the calibration data points and the assay data points, if desired.

The program can also produce plots of count rates versus time for long measurements; this is a valuable diagnostic feature.

The coincidence electronics packages presently supported are the Canberra JSR-11 and JSR-12, the Los Alamos MSR4, the Canberra 2150, and the Los Alamos and Aquilla PSR.

Results are stored in text and database files and can be reviewed and printed with a level of detail selected by the user. Results can also be written to a "spreadsheet" text file, where the user selects the information to be written; this provides a very convenient way to transfer selected results to commercial spreadsheet programs for further analysis.

An example of a display from the NCC program is shown in Fig. 5, where some assay results are being reviewed.

**Small Sample and Standards Characterization with NDA (T. E. Sampson, NIS-5).** This project is studying the feasibility of using calorimetry to accurately characterize low-mass (<10 g plutonium) plutonium samples in otherwise hard-to-measure matrices. One application of this work is to characterize low-mass standards of

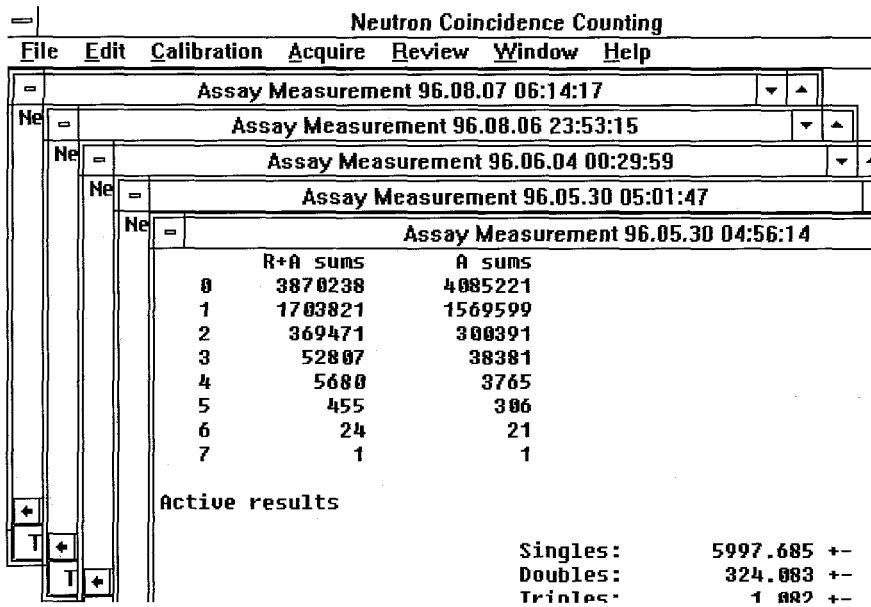

Fig. 5. Example of display from the Neutron Coincidence Counting (NCC) program.

plutonium in realistic matrices for calibrating matrix-dependent NDA techniques. Another application is to measure aliquots of  $\text{PuO}_2$  from large batches to characterize the entire batch, improving on a calibration-intensive neutron counting method.

This project is a collaborative effort between Los Alamos and EG&G Mound Applied Technologies. Los Alamos provided functional specifications for two different calorimeter systems to address the above measurement issues. Calorimeter #1 specifications were for a sample vial 0.75 in. in diameter by 2.5 in. long, sample power of  $\geq 10$  mW, and a precision and accuracy goal of 0.2% (1 RSD) at the low end of the power range. Calorimeter #2 specifications were for a sample container 7 in. in diameter by 9 in. tall, a power range of 2.5 mW to 125 mW, and a precision and accuracy of 1–2% (1 RSD). Cal #2 might be used to characterize a suite of residue containers that could be used to build up a drum standard for either subsequent gamma-ray or neutron measurements.

EG&G Mound responded by noting that Cal #1 requirements could be met with existing technology already in use

at Mound. They also proposed thermoelectric cooling as a replacement for the conventional refrigeration technology used in the past. We expect to receive a conceptual design of Cal #2 early in CY 1996 and will consider construction of a prototype unit if facility funding can be obtained.

**Weapons Isotopic Analysis with the Fixed Energy Response Function Analysis with Multiple Efficiencies (FRAM) Code (T. E. Sampson and T. A. Kelley, NIS-5).** We have developed, tested, and implemented software to analyze pulse-height spectra from gamma rays to determine the isotopic composition of plutonium-bearing items inside thick-walled or lead-lined storage containers. This new capability, for the first time, enables one to "see" inside thick-walled storage containers allowing inspection and verification of materials without unpacking or handling the plutonium items. The use of this new software allows measurements in inspection situations where national security interests prevent access to the measured items. This new capability also reduces the handling currently needed for measurements in processing

facilities reducing the radiation exposure to facility workers. This capability is being implemented at numerous facilities worldwide.

PC/FRAM is a code that analyzes the gamma-ray spectrum from a plutonium-bearing item and quantifies the distribution of the plutonium isotopes. Americium-241 and other transuranic isotopes (including uranium in mixed uranium-plutonium oxides, MOXs) that contribute measurable gamma rays to the spectrum can also be quantified relative to plutonium. The code also can analyze spectra from items containing only uranium and quantify the uranium isotopic distribution. These measurements are performed on samples of arbitrary size, geometry, and physical and chemical composition. The results are obtained without calibration using only fundamental tabulated nuclear constants. Isotopic results, such as those from PC/FRAM, are required for the interpretation of other types of NDA measurements (calorimetry, neutron coincidence counting, and segmented gamma scanning) in terms of total plutonium mass.

## History

The development of the FRAM<sup>5-8</sup> code began in the mid-1980s and was first fielded at the Los Alamos Plutonium Facility in 1988. This FRAM system is still (1995) in operation and has measured nearly 10,000 items since its installation. The FRAM system represented a major advance in measurement flexibility and updated measurement and analysis hardware to the state of the art at that time. It featured

- MicroVAX computer and VMS operating system with FORTRAN 77 programming,
- User-friendly menu with options to facilitate use,
- User-editable analysis parameters for flexible analysis (allows user to cope with arbitrary interference peaks),
- Response function analysis for peak areas,

- Heterogeneous Am/Pu analysis with multiple relative efficiency curves for improved calorimetry interpretation, and
- Capability for all spectral peaks to contribute to analysis via least-squares resolution of isotopic ratios.

### PC/FRAM<sup>9-10</sup>

By the early 1990s, computer hardware and software developments made the VAX/VMS-based FRAM system obsolete. The program was recoded in C to operate on a personal computer (PC) under Windows Ver. 3.1. This popular operating system has opened up the applications for the FRAM code (now called PC/FRAM) to many institutions that did not support the previous VAX system.

### PC/FRAM Characteristics

PC/FRAM preserves all of the principal features of the FRAM code while adding significant new capabilities.

#### Single Detector System

Like all previous Los Alamos isotopic analysis codes, PC/FRAM uses only a single detector to acquire its data. Single detector systems are inherently

- More versatile,
- Easier to use,
- Less expensive,
- More reliable, and
- Occupy less space in a facility.

#### Planar or Coaxial Detector

PC/FRAM is the only isotopic analysis system that can obtain a complete isotopic analysis using either a single planar or a single coaxial detector. See Fig. 6. When using the traditional single planar detector, PC/FRAM has most often been used to collect and analyze data in the 120–420-keV range, although it is not limited to this range. The most widely used mode of operation with a

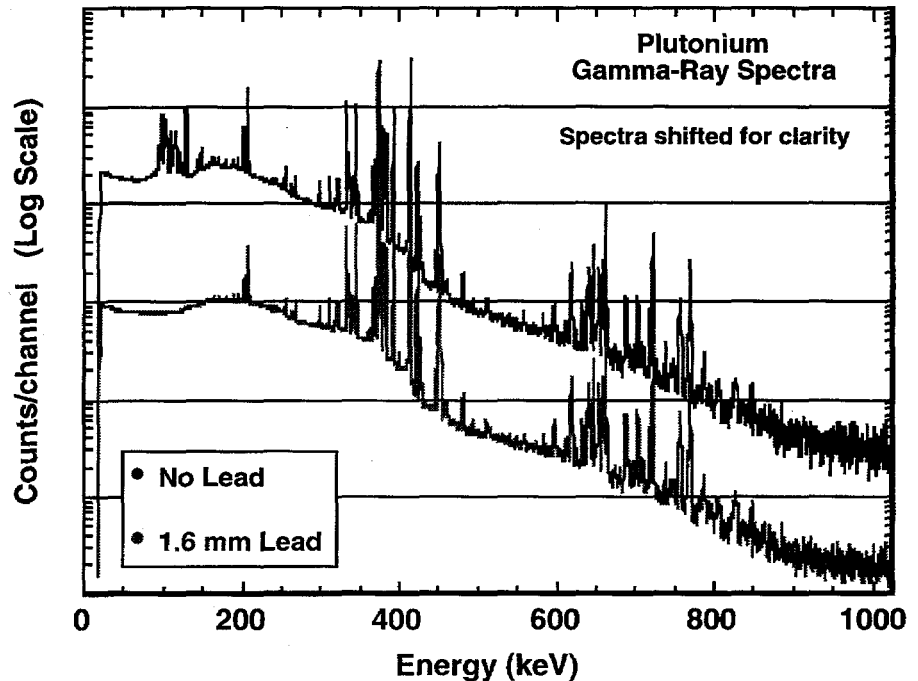

Fig. 6. The bottom spectrum shows that a small amount of shielding can remove all gamma rays with energies less than 200 keV. PC/FRAM is the only isotopic analysis code that can obtain a complete isotopic analysis on both spectra.

single coaxial detector is to acquire a single spectrum in the range from 0–1024 keV. Various analysis modes can then be used with this wide data range. If the widely used region between 120 and 200 keV is available, PC/FRAM will work best analyzing in an energy range from 120–450 keV. When analysis below 200 keV is precluded (by sample shielding or a thick-walled sample container) PC/FRAM can still obtain a complete isotopic analysis using only gamma rays above 200 keV from a single spectrum from a coaxial detector.

The optimum choice between planar or coaxial detectors can be made only after all applications are considered. The planar detector is usually the detector of choice if all measured items are unshielded or contained in “thin” containers. If shielded containers, thick-walled containers, or a mixture of thin and thick or shielded containers are encountered, then a single coaxial detector system is optimum.

#### Shielded Samples

Other isotopic analysis codes (including previous versions of FRAM) *require* the presence of spectral peaks in the region below 200 keV, regardless of whether the code acquires data from one or two detectors. When this region is not available to the spectroscopist, perhaps because the sample is shielded to lower radiation exposure or because the sample is inside a container with very heavy walls, other isotopic analysis codes will not function. The PC/FRAM code will function in these cases.

#### Flexible Data Acquisition and Analysis

The structure of the PC/FRAM code allows data acquisition and analysis for nearly all measurement situations without costly, time-consuming reprogramming. The user is not limited by hard-wired, fixed data acquisition conditions. Some examples of how PC/FRAM has been used are given in Table II.

**TABLE II. Some PC/FRAM Data Acquisition Conditions**

Detector	Analysis Range (keV)	Gain (keV/ch)
Planar	120-420	0.100
Planar	120-307	0.075
Coaxial	120-460	0.125
Coaxial	120-460	0.250
Coaxial	200-800	0.125
Coaxial	300-800	0.125
Coaxial	120-1200	0.156

### User-Editable Parameter Database

Acquisition and analysis is made flexible by placing all the parameters that govern data acquisition and analysis in a user-editable database. The user completely controls the setup of acquisition parameters, analysis parameters, diagnostic parameters, data-storage formats, and default and global settings. All parameters may be changed from within a password-protected (three levels of protection) Change Parameter option that has the look and feel of a standard spreadsheet.

The flexibility built into the structure of the PC/FRAM code has enabled it to analyze a wider variety of material types than any other analysis code; all analyses are done without any reprogramming. A list of materials analyzed with FRAM is given in Table III.

### Analysis Results

Figure 7 shows analysis results for the effective specific power ( $P_{eff}$ ) obtained from three different PC/FRAM analysis modes. The new single coaxial detector analysis modes offer very nearly the same measurement accuracy as the traditional single planar detector mode.

### Use of the PC/FRAM Code

The first copy of Ver. 1.1 of the PC/FRAM code was delivered in October 1994. Version 2.1, with over thirteen

major enhancements and additions, is planned for release in December 1995. Fifteen copies of the code will have been distributed worldwide by the beginning of 1996. Facilities that have PC/FRAM now include

- Los Alamos Plutonium Facility;
- Westinghouse Savannah River Site;
- Atomic Weapons Establishment (AWE), Aldermaston, UK;
- Dounreay, UK;
- Arzamas-16, Russia;
- Institute of Physics and Power Engineering (IPPE), Obninsk, Russia;

**TABLE III. Material Categories Analyzed with FRAM and PC/FRAM**

- 2 - 38%  $^{240}\text{Pu}$
- 0.01 - 50%  $^{241}\text{Am}$
- Interferences from  $^{243}\text{Am}$ - $^{239}\text{Np}$   
 $^{237}\text{Np}$   
 $^{244}\text{Cm}$
- 80%  $^{238}\text{Pu}$
- Lead-shielded samples
- Heterogeneous Am/Pu
- Nonequilibrium  $^{241}\text{Pu}$ - $^{237}\text{U}$
- MOX:  $^{235}\text{U}/\text{Pu}$  from 0.005 - 35
- 80 - 95%  $^{242}\text{Pu}$
- $^{235}\text{U}/^{238}\text{U}$  in uranium (only), no Pu
- $^{235}\text{U}$ ;  $^{241}\text{Am}$ : Pu = 24:1:1

- EURATOM;
- International Atomic Energy Agency (IAEA); and
- Plutonium Nuclear Fuels Corporation (PNC), Japan.

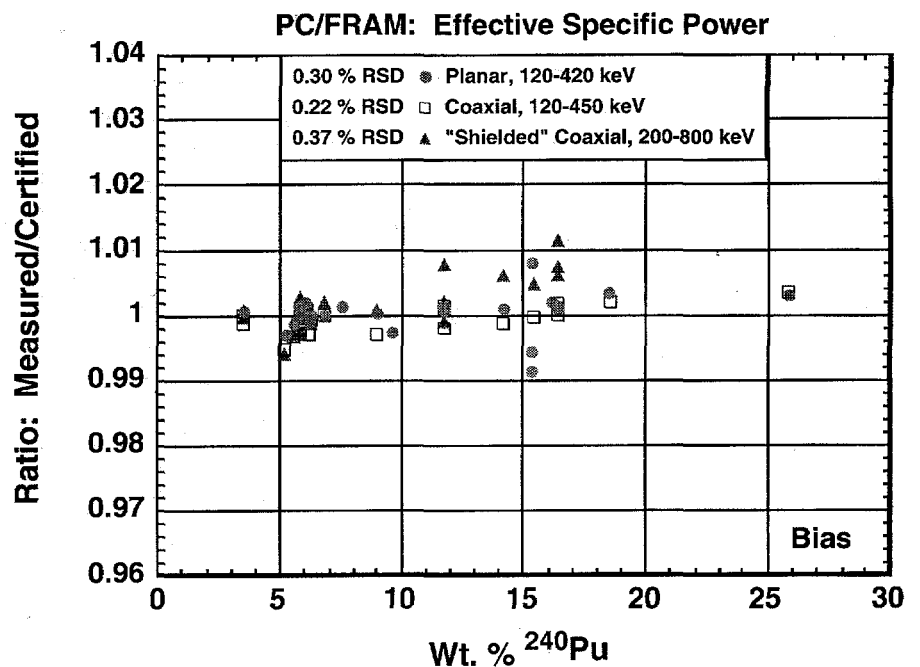

Fig. 7. The bias in the effective specific power for three different analysis modes.

**Automated Weapons Dismantlement NDA System (T. E. Sampson, W. Hansen, T. Kelley, C. Schneider, W. Harker, M. Krick, G. Walton, K. Kroncke, S. Bourret, and G. Sheppard, NIS-5).** ARIES (Advanced Recovery and Integrated Extraction System) is being developed by Los Alamos and Lawrence Livermore National Laboratory (LLNL) to demonstrate advanced methods for the extraction of plutonium from dismantled weapons components. This integrated system combines pit bisection and plutonium consolidation processes to produce a final plutonium metal (or oxide) product. This product and any waste produced in the processes are assayed in an automated NDA system as an integral part of the system.

The NDA system consists of four instruments (calorimeter, gamma-ray isotopic analysis, segmented gamma scanner, and a neutron coincidence counter). The latter three instruments are provided by the Safeguards Science and Technology group at Los Alamos while EG&G Mound Applied Technologies is supplying the calorimeter. All four instruments, while able to operate in a stand-alone mode, are integrated with a host computer and a gantry robot (provided by Los Alamos group ESA-MT) in a mock glovebox environment. The three Los Alamos NDA instruments were completed and installed this year. The integrated system will be tested during the next nine months.

Early in FY 97 the system will be installed in the Los Alamos Plutonium Facility in preparation for a process demonstration sponsored by the DOE Material Disposition program. The process demonstration, outlined in Fig. 8, will demonstrate the major components of the entire ARIES process, including NDA. The boxes labeled "Decon" remove plutonium contamination so items can be handled outside a glovebox environment. "Declass" is a process that changes classified shapes into unclassified items. All items for

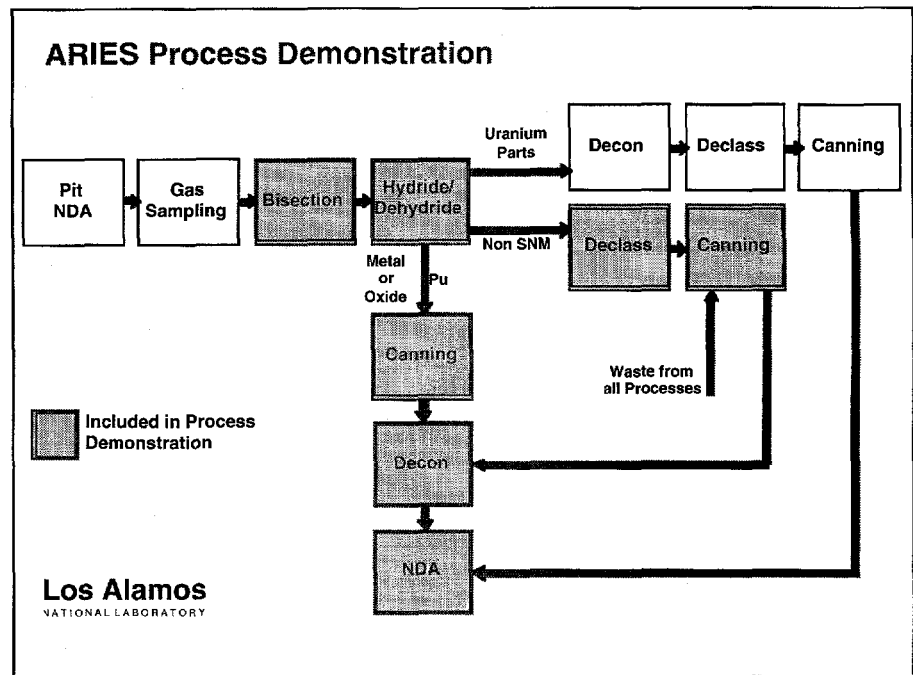

Fig. 8. Block diagram of ARIES process demonstration at the Los Alamos Plutonium Facility.

NDA measurement will be decontaminated so NDA measurements can be carried out in a clean environment.

A block diagram of the NDA system is shown in Fig. 9.

Most of the boxes in Fig. 9 are self-explanatory. The programmable logic controller (PLC) reads two dozen fiber optic sensors inside the mock glovebox. These sensors read the occupancy status of all the SNM-container storage positions and the mechanical status of the NDA instruments. This allows the NDA host computer to track the status of all operations in the NDA mock glovebox. The supervisory process control computer will be used to provide high-level control of all appropriate processes but may not be implemented in the process demonstration.

An accurate drawing of the NDA glovebox is shown in Fig. 10. Some modifications to this mock glovebox will be installed in FY96 as we change the containers and location fixtures to be compatible with containers suitable for long-term storage.

**Active/Passive Multiplicity Analysis of Weapons Components and Process Materials (D. G. Langner, NIS-5).** The purpose of this project is to extend the range of uranium- and plutonium-bearing materials that can be successfully measured using neutron multiplicity counting. This new technology provides rapid, accurate assays of many types of impure plutonium-bearing materials. Passive multiplicity counting was used by the IAEA for inspections of impure plutonium oxide materials at Hanford; the technique will soon be used at Rocky Flats. It is also being considered for use at LLNL to augment and speed up their plutonium inventory verifications, previously done solely with calorimeters.

Although the technique is coming into use within the DOE, problems still exist with it and new applications of it need to be explored. The technique has the potential to provide measurements that require either no standards or minimal standards for materials that were previously unmeasurable by other safeguards methods. Potential applications



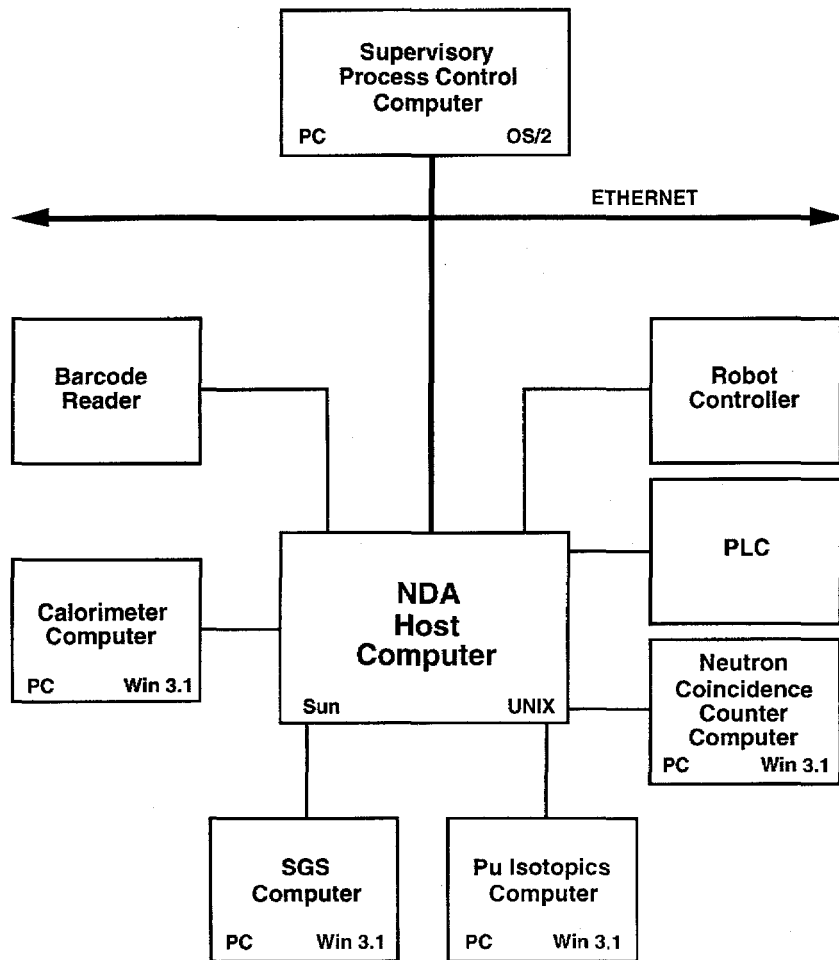

Fig. 9. Block diagram of the NDA system.

of the technique include the assay of plutonium-bearing weapon assemblies in storage containers, the assay of impure uranium metal and oxide, and the monitoring of plutonium in long-term storage.

Neutron multiplicity counters also provide a signature of a sample that can be used simply for verification purposes in those applications where mass information is not required. These instruments provide five or more measured quantities that characterize the neutron signature of a sample in a way that is difficult to mimic.

If it can be demonstrated that neutron multiplicity counting can indeed be successful for these types of problems, the DOE complex will save in chemical analysis, man-power, and

physical security costs. Because the technique is rapid and can be done in a process line, its application can also reduce the costs associated with personnel radiation exposure.

Investigations supported by this project have identified several problems that limit the application and the accuracy of neutron multiplicity counting. These limitations in the technique are caused by failures in the theory for some types of materials, notably compact plutonium metal items, and by some types of sample packaging. The latter problem notably affects large-mass plutonium samples that are typically stored in containers that include a neutron shield.

In this past year, two large multiplicity counters have been fabricated by

Los Alamos and delivered to two DOE sites: the Rocky Flats Environmental Technology Site (RFETS) and LLNL. The first of these instruments was delivered to RFETS to support IAEA inspections there. No other instrument could be used for these inspections because the plutonium offered for inspection is stored in 10-gal. drums. The latter instrument was delivered to LLNL to be used in their inventory verification. The LLNL instrument includes an active insert so that active multiplicity counting of large uranium samples can be studied. These instruments are important to this project because they can measure samples contained in packages of a size up to and including a 30-gal. drum. Previous multiplicity counters had much smaller capacities and could not be used to study the measurement of many of the difficult-to-measure, bulk items.

Figure 11 shows assay results obtained this year with these counters. For most samples the results are excellent. However, for a compact metal disk and for samples that were deliberately placed in neutron shields within large storage drums, the results are biased. These biases arise from the problems identified above. We have observed that the biases due to neutron shielding are correlated with the ratio of the neutron counts in the inner and outer rows of  $^3\text{He}$  tubes in these neutron counters. Figure 12 displays this correlation. We are studying the use of these "row ratios" to correct for these biases. We are also studying the mechanism that causes the break-down in the theoretical model for multiplicity counting when a compact metal sample is measured. A correction based on measurements made of other metal samples in a different multiplicity counter corrects the bias in the metal sample measured in the 30-gal. counter. We continue to investigate whether this correction is being correctly applied or just fortuitously yields the correct results.

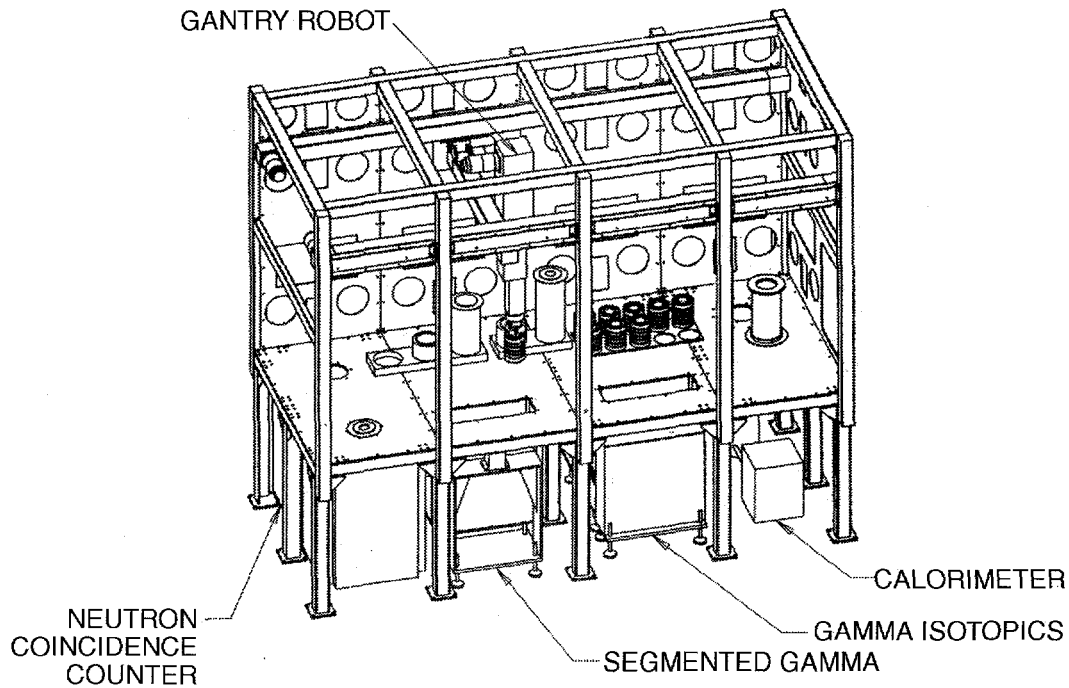

Fig. 10. The mock glovebox for the ARIES NDA system.

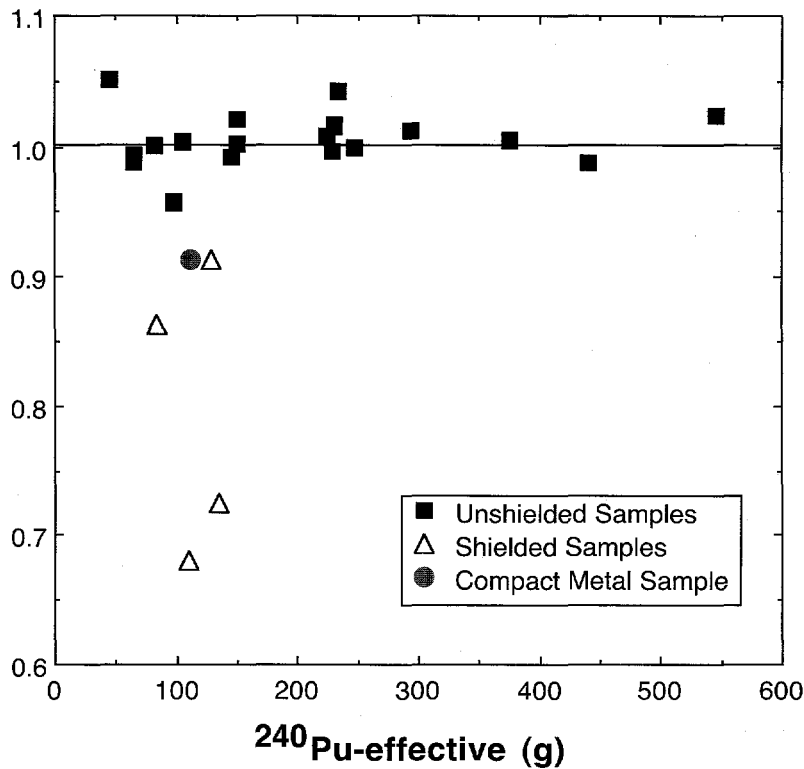

Fig. 11. Assay results show that neutron multiplicity counting is not accurate for shielded samples and compact metal samples.

**Room-Temperature Gamma-Ray Detectors for Nonproliferation and International and Domestic Safeguards** (P. A. Russo, M. C. Sumner, J. K. Halbig, S. F. Klosterbuer, J. K. Sprinkle, Jr., NIS-5; D. A. Close, NIS-6; and P. N. Luke, LBL).

### Introduction

Miniaturized, self-contained gamma-ray spectroscopy instruments are being developed at Los Alamos to improve quantitative NDA and characterization of nuclear materials using portable, on-line, and unattended equipment. The expanding arena of nuclear nonproliferation and international safeguards and the shifting emphasis of domestic nuclear safeguards have increased the scope of needs for gamma-ray spectroscopy measurements that apply to the following:

1. detection of nuclear smuggling or illicit presence of nuclear materials;
2. routine or special nuclear inspections;

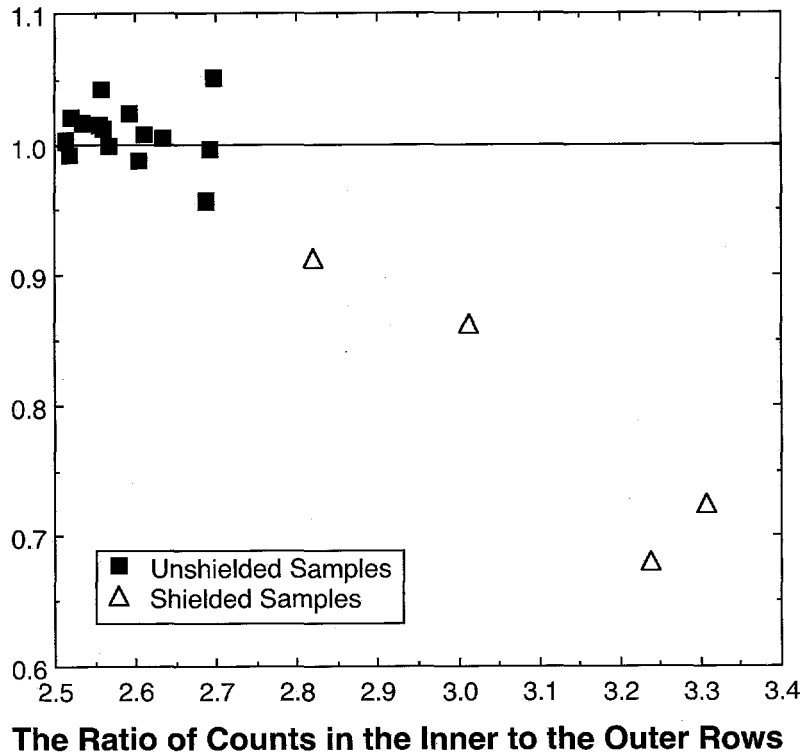

Fig. 12. The correlation between row ratio information and assay bias for shielded samples.

3. portable quantitative assay of holdup and in-process inventory;
4. monitoring and verifying nuclear material inventories in storage;
5. continuous, unattended gamma-ray monitoring of nuclear material flows;
6. termination of domestic safeguards in decontamination, decommissioning, and disposal activities;
7. nuclear surveillance; and
8. characterization of low-grade materials for certification as waste.

These field applications require room-temperature gamma-ray detectors with capabilities that exceed those of existing scintillator detectors. Portability and fieldability are enhanced with reduced power requirements, smaller/lighter detector packages, and increased ruggedness. Better gamma-ray energy resolution and gain stability would increase the accuracy, reliability, range of applicability, and sensitivity of the assay; the range of accessible material types and information available from the assay; and the rigor of the quality

assurance/quality control (QA/QC) for the spectrum.

We have begun implementing the Los Alamos miniature modular multichannel analyzer (M<sup>3</sup>CA), a self-contained and virtually pocket-sized spectroscopy instrument, to address the required enhancements for more fieldable/portable instruments with improved performance. However, the new solid-state room-temperature detectors such as CdTe and CdZnTe (counterparts to the modern M<sup>3</sup>CA instrumentation in portability, reduced power requirements, and increased ruggedness) are intrinsically deficient in the ability to fully collect the charge produced by gamma-ray interactions in the detector crystals. Therefore, although the energy resolution is improved over scintillator/photomultiplier detectors, the spectrum quality is not adequate because of severe low-energy tailing that arises from the charge-collection deficiencies.<sup>11</sup>

The coplanar-grid technology developed recently at the Lawrence Berkeley Laboratory to improve the performance

of room-temperature solid state detectors erases this deficiency from the signals produced by intrinsic, room-temperature, solid-state, gamma-ray detectors. The technology is unlike the complex circuitry for electronic rejection/compensation that is positioned between the detector and the spectroscopy system to eliminate defective gamma-ray pulse heights by filtering out badly shaped analog pulses or digitally compensating for their analysis defects or both. Rather, the coplanar-grid technology eliminates the defect before the signal leaves the detector by judiciously adding an electrode to the crystal to collect charge and by making a linear combination of the detector's own intrinsic analog signals from two electrodes to eliminate the influence of the ineffective charge carriers. The method is simple because both the improved resolution and the required spectrum quality are achieved with no losses/rejection of events and the spectroscopy-electronics requirements for the system remain unchanged. Furthermore, the size of the detector and its input requirements remain unchanged after the addition of a preamplifier and the summing circuitry. For portable, unattended, or on-line applications of gamma-ray spectroscopy, the existing (miniature, self-contained, battery-powered, rugged, and programmable for fully automated operation) M<sup>3</sup>CA spectroscopy system is immediately compatible with the coplanar-grid technology with no compromises on the fieldability of the system.

An example of the magnitude of problems with existing room-temperature detectors is illustrated below in the quantitative determination of the mass of <sup>239</sup>Pu in variable-to-high-burnup plutonium. Although the stated application is specific to fuel-cycle material, it also directly addresses some of the more difficult and far-reaching problems in the DOE production complex for portable, quantitative gamma-ray analysis. These problems arise from variable- and high-actinide materials in the operations areas in

which chemical (particularly pyrochemical) separations are used to purify recycled plutonium. The benefits of one of the first coplanar-grid CdZnTe detectors in these applications have been demonstrated.

### Bias in the NaI Gamma-Ray Assay of $^{239}\text{Pu}$ Mass

The quantitative analysis of  $^{239}\text{Pu}$  mass by low-resolution gamma-ray spectroscopy is performed with NaI detectors in portable measurements of gamma-ray spectra from in-process plutonium inventory and holdup.<sup>12-14</sup> The  $^{239}\text{Pu}$  gamma ray at 414 keV is the preferred signal for the assay because it penetrates the process equipment and the plutonium-bearing materials better than the lower-energy gamma rays. Furthermore, the gamma-ray continuum underneath this peak is less steep than at lower energies, and the energy region in which the peak is analyzed has fewer interfering gamma rays from other isotopes. The interference concerns arise mainly from gamma rays produced by  $^{241}\text{Pu}$  and  $^{237}\text{Am}$ .

The resolution of the compact sodium iodide detectors<sup>15</sup> used for these portable gamma-ray measurements determines the magnitude of the interference for each material type. (The resolution is  $7.3\% \pm 0.3\%$  full-width at half-maximum (FWHM) at 662 keV for the 2.5-cm-diameter by 5-cm-thick detectors.) Because of the low  $^{241}\text{Pu}$  content (less than 1%) of low-burnup plutonium, unbiased quantitative analysis of such material is achieved with these NaI detectors, even after several decades since chemical purification. The impact of age and burnup can be observed in the gamma-ray spectra of six reference samples of  $\text{PuO}_2$  that have been aged  $\sim 20$  years (since chemical purification) and were identical (including encapsulation) at the time of preparation except for the isotopic composition. Table IV describes the individual samples.

The gamma-ray spectra for samples 1, 4, and 6 obtained with the compact

**TABLE IV. Isotopic Distributions of 0.5-Gram Plutonium Oxide Reference Samples**

PuO <sub>2</sub> Reference Sample #	Isotopic Weight Percentage*					
	<sup>238</sup> Pu	<sup>239</sup> Pu	<sup>240</sup> Pu	<sup>241</sup> Pu	<sup>242</sup> Pu	<sup>241</sup> Am
1	0.01	93.85	5.97	0.14	0.03	0.28
2	0.02	89.51	10.07	0.31	0.09	0.40
3	0.05	84.90	14.13	0.69	0.23	0.91
4	0.10	78.24	19.81	1.28	0.57	2.10
6	0.90	67.59	24.22	3.71	3.58	5.17
7	1.22	63.41	26.06	4.58	4.73	5.77

\*Relative to total plutonium mass.

NaI detector and the Los Alamos M<sup>3</sup>CA correspond to the lower plots (larger points) in Fig. 13, a-c, respectively. The assay region of interest from 380 to 450 keV is dominated by gamma rays from the decay of the  $^{239}\text{Pu}$  isotope. The most intense gamma rays occur at 375 and 414 keV. The continuum background for this region is obtained from the counts in the higher-energy (500- to 535-keV) region. For the lowest-burnup samples (1 and 2), the lower-energy region (335 to 370 keV) is also dominated by gamma rays from the decay of the  $^{239}\text{Pu}$  isotope (including those at 345 and 375 keV), but also includes gamma rays from the decay of the  $^{241}\text{Pu}$  and  $^{241}\text{Am}$  isotope (including those at 323, 332, 335, 369, 371, and 377 keV). As burnup increases (with sample number in the case of the plutonium oxide reference samples), the contributions from the  $^{241}\text{Pu}$  and  $^{241}\text{Am}$  isotopes eventually dominate the lower-energy region and, because of the finite resolution, also influence the count rate in the assay region. The effects of the increased gamma-ray activity from decay of the  $^{241}\text{Pu}$  and  $^{241}\text{Am}$  isotopes can be observed progressively with increasing burnup in Fig. 13, a-c. The counts in the lower-energy region substantially exceed those in the assay region for sample 6, the highest-burnup spectrum plotted, while the reverse is true for the lowest-burnup spectrum (sample 1). The extent

of bias in the assay is quantified in Fig. 14. This is a plot of the normalized ratio of the net counts in the assay region to the reference value of the mass of  $^{239}\text{Pu}$  in the oxide sample for two series of measurements of samples 1-6 versus a measured ratio that depends on both burnup and age. Thus, the points for samples 1 and 6 are at the extreme left and right (respectively) of each measurement series. The measured ratio is the ratio of counts in the lower region to those in the assay region. This ratio is sensitive to both the  $^{241}\text{Pu}$  and  $^{241}\text{Am}$  isotope fractions, representing burnup and age respectively. The uncorrected assay is biased by 40% for the highest burnup sample (#7).

Because the bias in the assay appears to increase monotonically with the measured ratio for values of the ratio that exceed 1.2, a possible solution is to use this unique ratio measured for each spectrum to infer and correct for the large burnup- and age-dependent interference effects. However, three factors limit the use of this approach.

1. The container/equipment attenuation and the self-attenuation by the holdup deposit also influence the value of the measured ratio. (This influence does not affect the plutonium oxide reference samples because of their identical chemical composition, geometry, and packaging.)

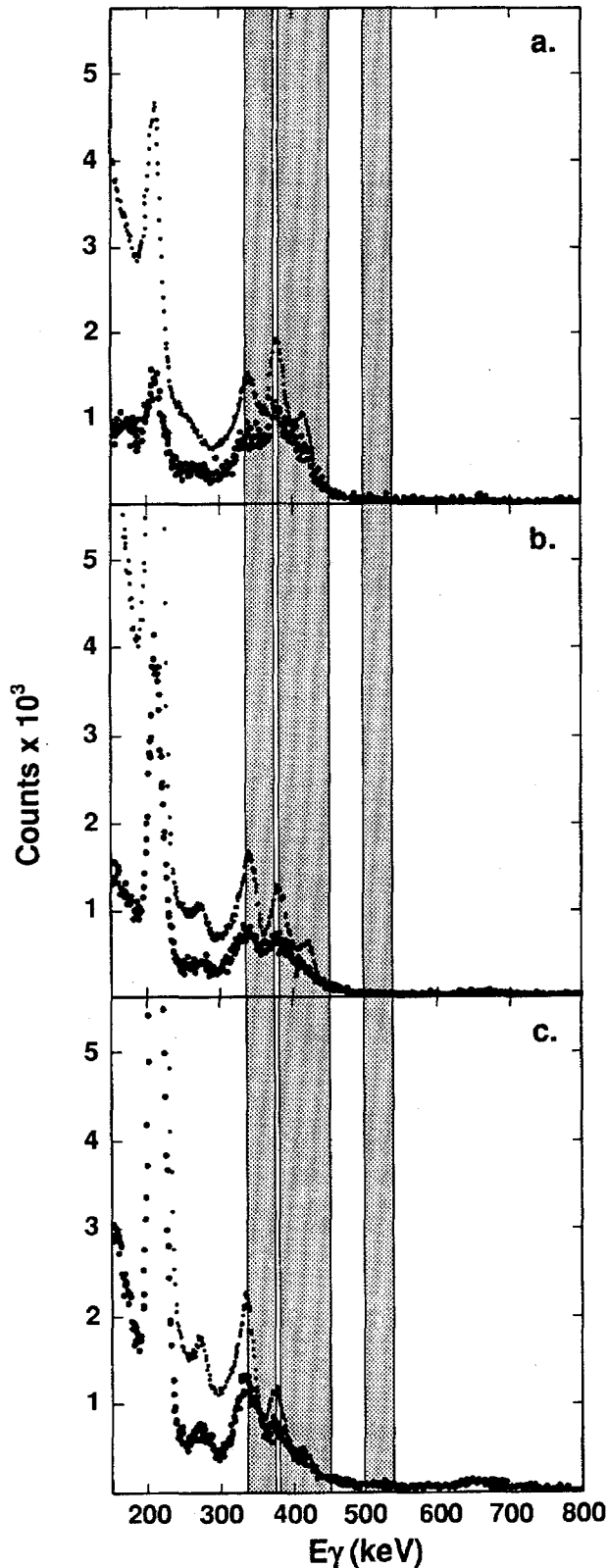

Fig. 13. Pairs of matched-gain gamma-ray spectra of three 0.5-g plutonium oxide reference samples obtained with the compact NaI (larger points) coplanar-grid CdZnTe (smaller points) detectors using the Los Alamos M<sup>3</sup>CA. The data for the lowest-, intermediate-, and highest-burnup samples, 1, 4, and 6, are the pairs of spectra in a, b, and c, respectively.

2. Interferences from isotopes other than those of plutonium and americium can also influence the value of the measured ratio.
3. The dependence of the bias on the measured ratio changes detector resolution.

The bias could be eliminated by using high-resolution gamma-ray spectroscopy, but this is prohibited for most measurements with portable equipment because of the inconvenience of the overall size and weight of the detector. However, the use of room-temperature detectors with better resolution than that provided by NaI detectors would reduce the magnitude of the burnup- and age-dependent bias, allow the use of more narrow and closely spaced energy regions for the correction process, and eliminate or mitigate the effects of the three factors that compromise bias corrections.

#### Room-Temperature Gamma-Ray Detectors for Improved Accuracy in the Assay of <sup>239</sup>Pu Mass

The gamma-ray spectra for reference samples 1, 4, and 6 obtained with one of the first coplanar-grid CdZnTe detectors and the Los Alamos M<sup>3</sup>CA correspond to the upper plots (larger points) in Fig. 13, a–c, respectively. The detector was a laboratory prototype made available by the developer at Lawrence Berkeley Laboratory (LBL), with a 1-cm<sup>3</sup> cubic crystal. Its measured energy resolution was 5.5%, FWHM at 662 keV. Even this relatively small improvement over the (7.3%) resolution of the NaI detector is apparent in superimposed (coplanar-grid CdZnTe and NaI) spectra of the three plutonium oxide reference samples in Fig. 13. Furthermore, the promise of further improvements comes with the publication of 2.5%, FWHM at 662 keV for the resolution of the most recent LBL prototype coplanar-grid CdZnTe detector.

With the cooperation of the LBL developer, the coplanar-grid CdZnTe detector technology is also being applied in commercial detectors. Delivery of the first commercial prototype

coplanar-grid CdZnTe detector is expected before the end of the calendar year. At that time, the quantitative analysis of  $^{239}\text{Pu}$  mass determined by gamma-ray spectroscopy will be re-evaluated with the new room-temperature detector and compared with the magnitudes plotted in Fig. 14 for NaI.

**NDA Consensus Standards Development for the American Society for Testing and Materials (ASTM) Subcommittee C26.10 (J. K. Sprinkle, Jr., NIS-5; and K. Coop, NIS-6).** We continue to support the transfer of technology

developed at Los Alamos by participating in the ASTM consensus standards process. The goal of ASTM is to promote standardization of measurement techniques for all users and at all facilities, thus providing results of equally excellent quality to all who use the technique. This year, we completed the test method for waste measurements based on a californium shuffler, passing the subcommittee ballot and presenting the test method for committee ballot. We worked on the five-year review of existing standards for the segmented gamma-ray scanner (SGS) and plutonium

isotopic measurements. We also made progress on developing a guide for holdup measurements and developing the test method for waste measurements using the differential dieaway technique.

**Consensus Standards Support for the American Society for Testing and Materials (ASTM) Subcommittee C26.12 (P. E. Fehlau, NIS-6).** For almost ten years, we have been participating in an effort by ASTM Subcommittee C26.12 to develop performance standards for perimeter security devices. The Subcommittee members include individuals from the National Laboratories, DOE Contractor Facilities, the Nuclear Regulatory Commission (NRC), and various manufacturers. We provide technical expertise on SNM monitoring. The Subcommittee developed and published six standards on SNM monitoring. These have been endorsed by DOE and were used in developing their material-control-element evaluation guides. Recently we participated in five-year reviews of the published standards and in completing the development of performance standards for the metal detectors that are used in conjunction with pedestrian SNM monitoring.

This year, we worked on developing a performance standard for evaluating the in-plant performance of walk-through metal detectors and a standard for designing entry-control stations to most effectively use SNM monitors, metal detectors, and related material-control elements. These have both entered the balloting stage and are nearing completion. Our review activities this year produced several minor changes for two published guides, ASTM C 1189-91 on SNM portal monitor calibration and ASTM C 993-92 on performance evaluation of automatic pedestrian SNM monitors. The former has been republished, and the latter is in the balloting stage.

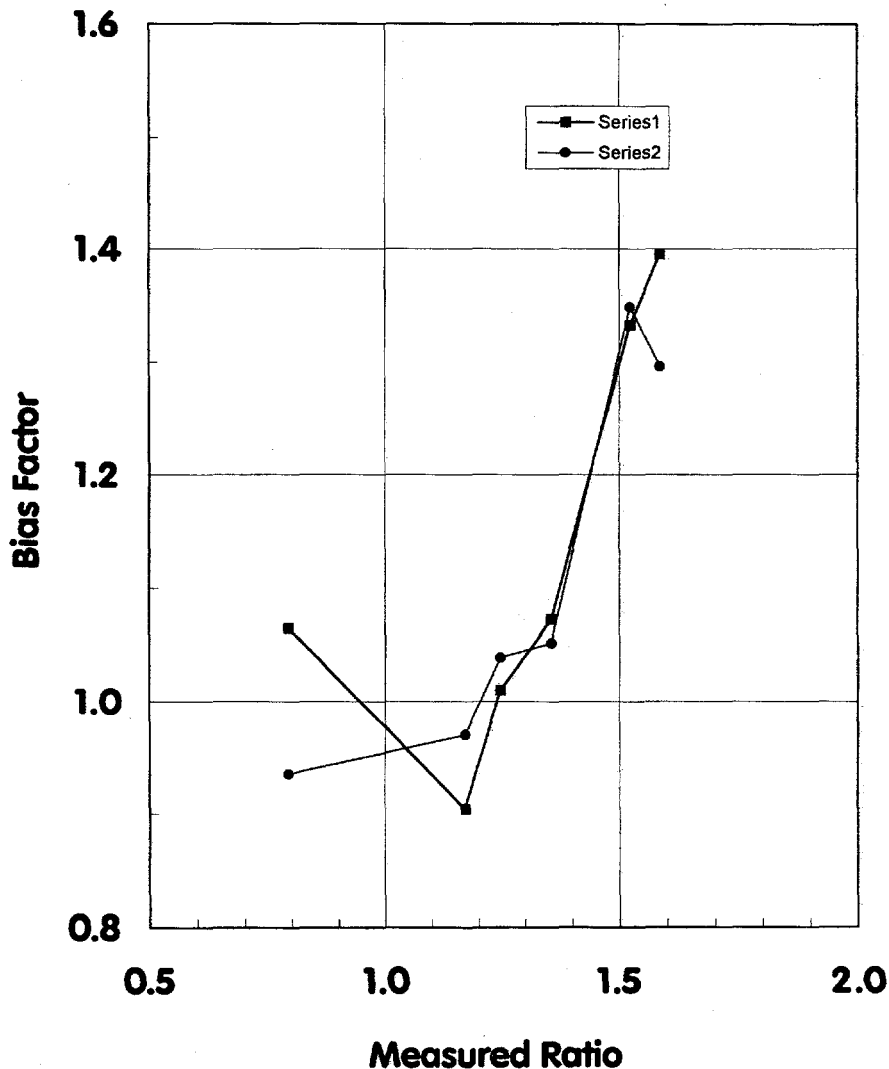

Fig. 14. Ratio of the assay result to the reference value for  $^{239}\text{Pu}$  mass of the six variable-to-high-burnup plutonium oxide reference samples plotted versus a measured ratio. The ratio depends on the burnup and the age of the sample.

**Dissemination of Technology Information in Support of SNM Portal Monitoring (P. E. Fehlau, R. York, and D. A. Close, NIS-6).** We provide information and assistance to those who must procure, install, maintain, evaluate, and properly use SNM monitors. This may require consulting to provide particular information needed for a project involving SNM monitoring or simply providing copies of published reports or ASTM standards on SNM monitoring. The following is a list of individuals or organizations that we have assisted during this fiscal year.

**Support for Russia.** We began our assistance to the former Soviet Union (FSU) under this program, and we later received support under the Lab-to-Lab program for continued assistance.

**Support for Belarus.** We provided requested assistance during the Defense Nuclear Agency's (DNA's) effort to procure SNM monitors for use at national borders. We later received funds from DNA to evaluate some of the equipment when it is delivered and to assist with training in the use of hand-held SNM monitors.

**Sandia National Laboratories.** We provided an estimate of SNM monitor effectiveness for detecting 4%-enriched uranium fuel pellets. We also provided information to a Sandia employee who is taking over responsibility for applying our neutron verification instrument (TSA Systems model NNV470A) for non-nuclear verification of test devices used in military flight tests. We provided information on the specifications for hand-held, pedestrian, and vehicle SNM monitors.

**Sandia Cooperative Monitoring Center.** We prepared a poster describing SNM monitors for display at the Center and responded to a request for demonstrations.

**Pantex Plant.** We discussed the alarm indicators used in our neutron vehicle monitor that is installed at the plant.

**Los Alamos National Laboratory.** We provided information on SNM monitoring to be used in discussions

about monitoring and controlling the radioactive component of hazardous wastes. We also provided the instrument repair shop with copies of our standard operating procedures for calibrating our neutron verification instruments (TSA Systems NNV470As).

**Oak Ridge National Laboratory.** We attended a meeting chaired by Oak Ridge National Laboratory on sensors that have been and should be included in the "Portal of the Future." We led a discussion about portal monitors and hand-held monitors, the advantages of the different types of monitors, and areas where improvement could be made. We explicitly stated areas of improvements needed for vehicle monitors and SNM package monitors. We have established ourselves as the center of expertise for SNM portal monitors.

**Rocky Flats.** We discussed the progress of implementing confirmation measurements with the Safeguards Measurements Group.

**DOE/HQ.** We responded to a request for copies of our book of ASTM standards on SNM monitoring<sup>16</sup> for use in a workshop held at the Central Training Academy.

**DOE/OR.** We provided a faxed copy of ASTM C 993-93 on pedestrian SNM monitor evaluation and mailed a copy of our book of ASTM standards on SNM monitoring.

**TSA Systems, Ltd.** We granted TSA Systems, Ltd., permission to translate our hand-held SNM monitor user's guide<sup>17</sup> and republish it in Russian. We have agreed to test TSA's new design, which has an RS-232 output to interface to a computer, for their controller for both their vehicle and pedestrian portal monitor.

**T. N. Technologies.** We discussed the response stability of plastic scintillators and possible means of active stabilization.

**Shonka Research Associates.** Again, we provided requested information; this year, the information was details for using our sequential probability-ratio test method for SNM monitor decision logic.

**Raytheon.** We provided information on vehicle monitoring as background material for planning a demonstration of such equipment at Kirtland Air Force Base.

**Ludlum Measurements.** We provided copies of the two editions of our hand-held SNM monitor user's manual.

**Gundula Sundgren.** We provided copies of reprints of SNM monitoring articles for this Finnish customer.

**Technical Associates.** We provided a copy of our book of ASTM standards on SNM monitoring.<sup>16</sup>

**Nuclear Plant Journal.** We provided the editor with information on commercially available vehicle SNM monitors that might prevent import of radioactive materials.

**Canberra Industries.** We provided printed information on SNM monitors and answered specific questions about the technology on several occasions. We have agreed to test and evaluate Canberra's new pedestrian and vehicle portal monitors.

**Mario Overhoff.** We provided an overview of SNM portal monitoring including some of the difficulties that can be encountered in producing competitive monitors.

**National Nuclear Corporation.** We provided information on how to calibrate their HM-3 hand-held SNM monitor.

**Nuclear Research Corp.** We provided copies of various reports and conference papers on the sequential-probability-ratio method used for detection logic in some of our commercialized SNM portal monitors.

**Updated Vehicle SNM Monitor Applications Guide (P. E. Fehlau, NIS-6).** We developed an outline for an updated applications guide on vehicle SNM monitoring that will incorporate new and prospective developments in the technology. The guide will also review the basics of the technology in more detail than was provided in the original guide. We then began writing a first draft of the updated guide. During the year, we were able to complete

first-draft text for parts 1, "A Review of the Basics of Vehicle SNM Monitoring," and 2, "Technical Ingredients of Vehicle SNM Monitoring," and we began writing the final part, a "Catalog of Vehicle SNM Monitors."

**Combined Thermal/ Epithelial Neutron (CTEN)/Tomographic Gamma Scanner (TGS) Package Monitor (K. L. Coop and C. L. Hollas, NIS-6).** We continue to examine the capability of various assay instruments and techniques to detect contraband fissile materials in packages and containers. Last year, we reported on the ability of the TGS to detect plutonium shielded by lead and other materials.<sup>18</sup> This year we began our examination of the "concealed" plutonium detection capability of the CTEN instrument. This instrument is being developed by our group for EM-50, for the assay of transuranic waste, but we use it for the current safeguards-related measurements while it remains at Los Alamos. It is scheduled for shipment to Idaho National Engineering Laboratory (INEL) in FY97.

This year, we made a series of measurements using plutonium and uranium sources to determine which of two neutron generator systems provided the better interrogating neutron spectrum for distinguishing dispersed from spatially concentrated forms of fissile material. We completed these measurements and found that one system produced significantly better results, primarily because it generates fewer neutrons after the end of the nominal neutron production period. This permits us to detect fission neutrons without interference from the interrogating flux at earlier times when the interrogating flux has a higher average energy, and thus is more penetrating. We continue to use that generator for measurements related to the package monitor project.

We then made measurements with plutonium sources inside a set of polyethylene and lead cylinders to determine their effect on our ability to detect plutonium or the presence of shielding materials or both in the package, which

in this case was a 55-gal. drum. The measurements were made with both the active-mode neutron interrogation, detecting singles and coincident induced-fission neutrons, and the passive mode, measuring neutron multiplicities from the spontaneous fission of plutonium. We collected the singles counts in time-gated scalars, while the coincidence and multiplicity data were collected in our list-mode neutron counting module, called the PATRM (Pulse Arrival Time Recording Module). The PATRM enables us to analyze data using a variety of techniques and algorithms, including some that cannot be used with a shift register.

A variety of flux monitors were used to obtain data on the effect of the shielding materials on the interrogating neutron flux intensity and dieaway time. The data obtained have not been completely analyzed, but we were easily able to detect a 100-g plutonium source in all the shielding materials we used, up to 0.5 in. of lead and 3 in. of polyethylene. Additional shields will be fabricated to enable us to span a greater range of shielding thicknesses and complete the CTEN measurements in FY96.

**Implementation of Neutron Counting Techniques at U.S. Facilities for IAEA Verification of Excess Materials from Nuclear Weapons Production (J. E. Stewart, M. S. Krick, D. L. Langner, T. D. Reilly, P. A. Russo, NIS-5; M. C. Lucas, N. J. Nicholas, NIS/NAC; W. Theis, R. J. Lemaire, and J. Xiao, IAEA).** The U.S. Nonproliferation and Export Control Policy, announced by President Clinton before the United Nations General Assembly on September 27, 1993, commits the U.S. to placing under IAEA Safeguards excess nuclear materials no longer needed for the U.S. nuclear deterrent.

As of September 30, 1995, the IAEA had completed Initial Physical Inventory Verifications (IPIVs) and first annual Physical Inventory Verifications (PIVs) at two facilities: a storage vault in the Oak Ridge Y-12 plant containing HEU metal and another storage vault in the

Hanford Plutonium Finishing Plant (PFP) containing plutonium oxide and plutonium-bearing residues. Another plutonium-storage vault, located at Rocky Flats, is scheduled for the IPIV in the fall of 1995.

Conventional neutron coincidence counting is one of the routinely applied IAEA NDA methods for verification of uranium and plutonium. However, at all three facilities mentioned above, neutron NDA equipment had to be modified or developed for specific facility needs such as the type and configuration of material placed under safeguards.

At Y-12, the size and mass of items to be verified required modification of the Active Well Coincidence Counter (AWCC).<sup>19,20</sup> The facility prepared a set of calibration standards representative of the items to be measured. The IAEA certified these standards by destructive analysis (DA). Compared with operator declarations for <sup>235</sup>U mass (weighing and isotopic analysis), the IAEA AWCC measurement values agreed to within  $0.5 \pm 0.5\%$  for randomly selected items.

At Hanford, the IAEA used the standard High-Level Neutron Coincidence Counter (HLNC)<sup>21</sup> for verification of pure PuO<sub>2</sub>. To verify plutonium material containing unknown impurity concentrations, the IAEA used a 3-Ring Multiplicity Counter (3RMC) provided by Los Alamos. The 3RMC gave better results for the impure material than could have been achieved using the HLNC.

Also, the 3RMC showed an improvement in measurement performance for pure PuO<sub>2</sub> because of higher efficiency than the HLNC.

In August 1995, a second IPIV was conducted at Hanford, in which the inventory was approximately doubled. Compared with operator declarations (calorimetry and gamma-ray spectrometry), the 3RMC measurement values agreed to within  $1.5 \pm 5.5\%$  for randomly selected plutonium-residue items.

At Rocky Flats, a new large neutron multiplicity counter<sup>22</sup> designed for



multiple-can plutonium oxide containers will be used for the IPIV. This will enable measurement of multiple-can items and thereby reduce radiation exposure to plant personnel as well as inspectors. Also, this counter is expected to be used for the facility's as well as the IAEA's verification purposes for a variety of nuclear materials present at this facility. The counter was designed to accommodate up to 30-gal. drums.

## Conclusions

The excellent quality and uniformity of material at Y-12 enabled unprecedented accuracy and precision for IAEA verification of HEU metal castings. Also, the quantity of material verified during the IPIV was unsurpassed in IAEA experience.

Because of the high impurity levels in some of the Hanford plutonium samples, conventional neutron coincidence counting is unsatisfactory; the assay masses are biased high beyond the limit of acceptance for partial defects detection. Multiplicity counting is the best neutron assay method for most of the inventory because it provides the lowest bias, but the technique requires excessively long counting times for samples with very high ( $\alpha, n$ ) to spontaneous fission neutron ratios. For those samples, studies in progress suggest that the multiplicity technique can be augmented by a known-multiplication analysis to rapidly verify impure oxides for partial defects detection, in most cases. The joint use of multiplicity counters and calorimeters combined with germanium isotopic systems is very promising, in principle, for IAEA verification. The neutron counter with the isotopics system quickly verifies the authenticity of the sample and determines the plutonium mass, in most cases, at the partial defects level; the calorimeter and the isotopic system then determine the most accurate plutonium mass, in most cases.

The multi-can, impure plutonium oxide items to be verified by the IAEA at Rocky Flats as well as a variety of

process residues present new challenges and opportunities for implementation and further development of neutron counting.

Experience gained by the IAEA in U.S. facilities will be applied in other nations that also offer excess nuclear weapons materials to international inspection.

**Performance Demonstration Program (PDD) for Waste Isolation Pilot Plant (WIPP) (Mark M. Pickrell, NIS-5).** We have been contributing to the PDD for WIPP. The purpose of the WIPP PDD is to demonstrate that NDA equipment can measure waste destined for WIPP to the accuracy required by the WIPP Waste Acceptance Criteria. Most recently, we contributed to the design of the blind test samples of the PDP test.

The PDD will use a series of blind test samples to measure the capability of NDA equipment to assay waste. Waste assay instrumentation will measure these blind standards to determine the precision and accuracy of the assay. The intent of the sequence of tests (nominally occurring every 6 months) will be to test the measurement capability of the instrumentation on simulated waste. The initial PDD cycle has been carefully designed to provide a measurement baseline; there are as few interfering effects as possible. Subsequent cycles will present more difficult measurement challenges and will attempt to span the measurement conditions outlined in the Baseline Inventory Report (BIR). The BIR is an inventory of all transuranic (TRU) waste throughout the DOE complex and represents the waste inventory destined for the WIPP site.

This is the description of the design of the sources and drums for the PDD, both initial and subsequent cycles.

## Background

The PDD is designed to be a blind test of the NDA capability of TRU waste. Seven DOE laboratories are part

of the initial program: Los Alamos, INEL, Oak Ridge, Hanford, Pacific Northwest Labs, Lawrence Livermore, and Rocky Flats. The PDD test is designed to insure that the NDA capabilities of these labs satisfy the requirements of the Quality Assurance Program Plan (QAPP) for WIPP. The PDD is implemented as a series of cycles; each cycle includes a set of blind tests. The initial cycle was designed to be as straightforward as possible, with subsequent cycles becoming progressively more difficult by introducing variations in isotope and matrix.

Each PDD test will consist of the measurement of particular standards inserted into 55-gal. test drums. The drums will be used to simulate the different matrices found in TRU waste. The source standards will contain quantities of weapons-grade plutonium and perhaps other impurities.

The initial cycle was carefully designed to establish baseline NDA capabilities. The matrix drums for this cycle were either entirely empty or were essentially benign. No matrix testing was to be done on the first cycle. The initial source standards were constructed using only high-purity, weapons-grade plutonium. No other radionuclides were included (although some americium is present at levels typical of moderately aged TRU waste).

The sources were designed by Los Alamos and INEL and are being constructed at Los Alamos. Even though the intent of the source design was to provide a baseline measurement, the implementation was more difficult in practice. Normally, standards and sources are designed to be specific to a particular NDA instrument. For example, the calibration source for a neutron counter would be quite different from the source designed for gamma-ray measurements. However, the essential presumption of the PDD was that the sites were free to choose any NDA method they deemed appropriate. No specific method was required or recommended. Therefore, to test the NDA capability, the initial cycle sources had

to be as easy to measure as possible and also "fair" to all instruments. The sources were designed in such a way that neither neutron or gamma-ray instruments were preferred.

The consequence of making the standard of equivalent difficulty for both neutron and gamma instruments was that it was somewhat more difficult to measure than originally intended. The sources consist of plutonium oxide dispersed in diatomaceous earth (DE). The mixture is contained in zirconium alloy tubes that are doubly sealed. The mixture is also compressed so that there will be no movement of the material. Diatomaceous earth was selected to insure that the plutonium oxide was sufficiently dispersed that self-shielding would be minimal for active thermal neutron methods. It also stabilized the plutonium distribution. Special DE was selected (called Kieselguhr) with minimal impurities to reduce the alpha-neutron emission. High-purity plutonium oxide was selected. The impurity levels were measured using d.c. arc emission and inductively coupled plasma (ICP) mass spectroscopy. The plutonium oxide was also screened and the resulting particle size distribution was measured using laser interferometry. These methods insured that a negligible fraction of the particle sizes exceeded 250 microns and that the mean of the particle-size distribution was nearly 30 microns. The small particle size is necessary to reduce neutron self-shielding effects and gamma-ray lump effects. Microscope images, before and after mixing with the DE, were taken to insure that the average particle size remained small. The tube geometry was designed to minimize bias effects in SGS's. SGS simulations were run to determine the best standard tube geometry to minimize bias errors. Thin-wall zirconium alloy tubes were selected to minimize both neutron and gamma-ray attenuation. Extensive MCNP simulations were conducted to determine the level of neutron attenuation for both thermal, interrogating neutrons and high-energy fission neutrons.

The source design was adjusted until these bias effects were well within the error limits established by the PDP and QAPP. Test samples of the plutonium oxide and DE mixture were counted in passive neutron counters to determine the ratio of alpha-neutrons to fission neutrons (the result was 1.5). The resulting design was a compromise between the bias effects for passive neutron, active neutron, and segmented gamma-ray measurements. An extensive quality assurance program has been implemented that samples the source material a minimum of three times to insure homogeneity, low impurity content, and small particle size. These samples are analyzed statistically (Student's t distribution) to insure that the design specifications have been satisfied. The sources are not optimized for any of these methods, but the bias effects are within the specified bounds of the PDP and the measurement "difficulty" has been as evenly partitioned as possible.

Each PDP cycle consists of four measurement ranges, each with a nominal plutonium mass of approximately 0.1 g, 1 g, 10 g, and 160 g of plutonium. The sources for the lowest three ranges are being constructed at Los Alamos. Each range will have three source standards that can be inserted into 55-gal. test drums in unknown combinations. Each of the three individual standards has plutonium mass loadings of approximately one third the nominal value for that range. One set of these (nine) standards will be distributed to each of the seven DOE laboratories participating in the PDP. The initial cycle of the PDP is scheduled to commence in December 1995.

The intent of the PDP is to establish the NDA measurement capability of TRU waste for the DOE labs. The intent of the initial cycle was to test the baseline capability with as easy and as a fair a test as possible. Subsequent PDP cycles will be progressively more difficult and will as closely as possible mimic the types of TRU waste anticipated. The basis for the design of the

subsequent cycles is the BIR, which lists and categorizes all the TRU waste complex-wide. Subsequent cycles will involve more difficult matrix drums and also source standards with interfering radionuclides and different plutonium isotopes.

### Subsequent Cycle Design

The combination of the matrix drums and the source standards is to simulate, to the extent possible, the spectrum of TRU waste enumerated in the BIR. The committee first evaluated the additional sources that would be required to simulate the spectrum of TRU waste. Note that the additional sources can be mixed with the original pure plutonium sources in a single 55-gal. drum. The committee decided that six general physics issues needed to be addressed with the source design:

1. **Particle size.** The original standards had a carefully controlled particle size to reduce or eliminate self-shielding and lump effects. Real TRU waste has no such quality control; the particle size distribution varies more widely. Therefore, some new standards need to be fabricated with a more realistic particle size distribution. The original standards were fabricated so that the mean of the particle size distribution was 30 microns with a negligible fraction above 250 microns. These standards will be fabricated so there is a substantial fraction of the particle size distribution above 250 microns.
2. **Samples (160).** Standards were fabricated for only the lowest three (of four) nominal ranges in the PDP. Sources for the largest range need to be fabricated to complete the measurement set.
3. **Americium content.** The americium content in TRU waste ranges from a low of  $\leq 0.1\%$  in weapons-grade material to a high of nearly 1:1 in TRU waste from Rocky

Flats residues. The americium is important because it is a prolific gamma-ray emitter that interferes with gamma-ray measurements. It also decays by alpha particle emission, which is the source of alpha-n neutrons. Alpha-n neutrons contribute to the neutron singles rate, which reduces coincidence or multiplicity precision.

The alpha-n rate depends on both the alpha emission rate of radionuclides and the chemical composition of the matrix (fluorine for example is a prolific emitter). Several of the matrices enumerated in the BIR have significant alpha-n neutron rates due to the chemical composition as well as an enhanced americium concentration. This effect cannot be easily simulated in the test drums because the alpha-n emission requires the SNM and matrix to be mixed on a molecular level, which is not practical with the separate sources and matrix drums used in the PDP. However, we can use americium samples to simulate an enhanced alpha-n rate from samples with either a high americium concentration or from those with matrices that enhance the alpha-n rate.

The americium will be mixed with plutonium in a nominal ratio of 0.5/1. Lower effective ratios can be achieved by combining this source with the weapons grade (WG) plutonium sources in the same drum.

4. **Plutonium isotopics—specifically plutonium-238.** The quality objectives for the initial cycle PDP and the QAPP data assume that the quantity being measured is only WG plutonium. This assumption is implicit; there are data quality objectives for only a single quantity of TRU waste: the specific alpha activity. However, the WIPP Waste Acceptance Criteria

(WAC) actually specify two quantities that must be characterized: the specific alpha activity and the fissile gram equivalent (FGE) (amount of fissile material). The FGE and the specific alpha activity (nanocuries per gram) are related by a constant, assuming fixed isotopics. The data quality objectives (DQO) in the QAPP assume WG plutonium isotopics exclusively to establish this connection. The nominal measurement ranges specified in the QAPP and the PDP test both the specific activity at the 100 nanocurie per gram level for the TRU/Low Level Waste (LLW) fiducial and the 200-g FGE cut-off for TRU waste. To test that the NDA capabilities meet the WIPP WAC, the instrumentation must be able to discern the plutonium content and the specific alpha activity independent of the isotopics. Two types of standards will be fabricated to test this aspect (as well as general isotopic sensitivity). The first will be to vary the plutonium isotopics by fabricating "heat-source" plutonium standards consisting of primarily plutonium-238. Another possibility would have been to use reactor-grade plutonium, but the essential physics can be tested by mixing heat-source and WG plutonium standards in different configurations.

The heat source plutonium (Pu-238) standards will be made in quantities that match the nominal plutonium mass ranges for the PDP. These mass ranges are listed in Table V.

5. **HEU standards.** Uranium is present in some fraction of TRU wastes; this TRU waste consists of mixed uranium and plutonium. HEU is significant in TRU waste because it is fissile material and has the effect of changing the ratio of the FGE to the specific alpha activity (uranium has a

negligible alpha emission rate). Therefore, it is another test of the isotopics sensitivity. HEU must also be measured to insure that waste drums remain below the 200-g FGE limit.

The HEU standards will be made in quantities that match the nominal plutonium mass ranges for the PDP. These mass ranges are listed in Table V.

6. **Fission products.** We will not construct standards for fission products because these can be purchased commercially. However, the issue of including fission product sources is important as another possible interference mechanism. We are considering including cesium, curium, or perhaps other fission product sources to simulate the interferences that exist in real TRU waste.

These sources will be placed in drums with the existing WG plutonium sources to create blind samples with varying quantities of plutonium mass, plutonium and uranium isotopics, particle size, and americium contamination. Not all standard source combinations are necessary for all nominal measurement ranges. For example, heat source plutonium in the nominal 160-g range might present a hazard from radiation exposure. Also, in some cases multiple samples will be fabricated that can be

Table V. Source Standard Types

	0.1 g	1 g	10 g	100 g
WG Pu			4	
HEU	0	1	3	2
Am/Pu	1	2	2	1
Particle Size	1	1	1	1
Heat Source	3	1	0	0

combined to cover two measurement ranges (the lower using quantities of one and the higher using quantities of two to three). Table V lists the number of sources to be fabricated for each type in each measurement range.

These sources will be combined in drums with the existing plutonium standards. (The existing standards consist of three standards each in the lowest three mass ranges). Each of these source complements is replicated for each site.

The committee also considered the types of matrices to be simulated in the test drums. The test drums are standard 55-gal. drums with insert tubes into which the source standards are placed. The simulated matrix is built permanently into the drum. Therefore, a single PDP-cycle blind test consists of inserting some combination of the source standards (unknown to the applicant) into one of the test drums. The first PDP cycle consists of two test drums; one empty and one containing a benign matrix material called ethafoam. The ethafoam is a very-low-density plastic foam.

The subsequent cycle drums are designed to simulate the anticipated waste matrices enumerated by the BIR. The committee considered whether certain matrices tested the same physics parameters, and were therefore redundant, and how prevalent the waste form is in the over-all DOE TRU inventory. Eleven waste classes are defined in the BIR:

1. Solidified Inorganic Sludge (Sol. In. Sludge)
2. Salt
3. Solidified Organic Sludge (Sol. Or. Sludge)
4. Soil
5. Mixed Metals without lead and cadmium
6. Mixed Metals with lead and cadmium
7. Combustibles
8. Graphite
9. Filters (HEPA)

10. Heterogeneous (This means mixed matrix. All matrices may be spatially inhomogeneous).

11. Inorganic Non-Metal (This means glass and concrete). We split this out into 11a. Glass (Raschig rings) and 11b. Non-glass.

When type 11 (Inorganic Non-Metal) is split into two forms, there are a total of 12 matrix categories, exceeding a reasonable number of PDP cycle tests, in particular, when various source combinations are included for each matrix type. The committee sought to reduce the number of matrix types to a more tractable number. Therefore, we searched for matrix types that would test the physics of several of the matrix categories.

Five physics issues were identified that pertain to the NDA assessment. These physics issues are the types of interferences that the 12 matrix categories represent to NDA instrumentation in a general sense. The five physics interference categories are as follows.

1. **Moderation level.** This is the amount of hydrogen present in the matrix because hydrogen is the primary neutron moderator.
2. **Neutron poison level.** Poisons such as chlorine also attenuate both passive and active neutron signals.
3. **Homogeneity.** In this context homogeneity refers to the spatial distribution of the material (rather than the mixed matrix issues).
4. **Mass density ( $\rho$ ).** Mass density affects both neutron and gamma-ray attenuation. Highly dense samples will be more attenuating to all NDA methods.
5. **High gamma attenuation.** This parameter refers to the presence or high concentration of materials with a high gamma-ray attenuation coefficient,  $\mu$ . Examples are high-atomic-number (high-Z) materials, such as metals, that effectively shield gamma rays.

Each of these NDA physics issues must be tested within the context of the PDP program at some level. However, to reduce the number of separate matrix tests, the committee attempted to reduce the number of redundant tests of each interference effect. Table VI lists the physics issue that is tested by each of the 12 matrix types specified by the BIR. The table lists only that the physics issue is tested and does not provide a quantitative measure of the extent of the interference from each matrix type; therefore, some judgement was exercised. However, Table VI does provide an approximation of the spectrum of matrix types that are necessary to fully qualify the NDA instrumentation under the auspices of the BIR inventory. An "X" in any column indicates that the indicated physics issue applies. A "~" mark indicates that the physics issue may apply somewhat. An absence of a mark indicates that the physics issue is not tested for that matrix.

From the analysis of Table VI, the committee decided that the range of NDA instrument interference could be adequately tested using a subset of the matrix types specified in the BIR. The subset of test cases for the PDP is the following.

Matrix Number	Matrix Type
1	Solid Inorganic Sludge
3	Solid Organic Sludge
6	Mixed Metals w/Cd, Pb
7	Combustibles
10	Heterogeneous
11a	Glass/Raschig Rings

These matrix types span the entire range of TRU-waste matrix measurement difficulty from an NDA viewpoint. They are sufficiently varied to test the entire range of instrument operation. These matrix types will be implemented during the subsequent PDP test cycles. In addition, the empty drum and benign matrix (ethafoam) will also be tested during the initial cycle.

The remaining issue to be decided was the selection of matrix types and source combinations. Not all source

**Table VI. Physics Issues Affected by Each Matrix Category**

Matrix Number	Matrix Type	Neutron Moderation	Neutron Poison	Heterogeneous Density	Mass Attenuation	Gamma
1	Sol. In. Sludge	X	~	X	X	
2	Salt	X	X	X	X	
3	Sol. Org. Sludge	X	X	X	X	
4	Soil	X	X	X		
5	Mixed Metals	X	X	X		
6	Mix Met w/Cd, Pb	X	X	X	X	
7	Combustibles					
8	Graphite	X	X			
9	Filters					
10	Heterogeneous	~	~	X	~	~
11a	Glass/Raschig	X	X	X	X	X
11b	Concrete	X	X	X	X	X

types need to be tested with all matrix types because those combinations are not prominently represented in the BIR. For example, the solidified inorganic sludges and the solidified organic sludges are essentially cemented solutions. There is no reason to expect large particle sizes from plutonium in solution. Therefore, we do not test the large-particle-size sources with the sludge matrix drums. We also do not test heat source plutonium with the glass (Raschig rings)/inorganic non-metals because the majority of this waste form is Raschig rings from conventional (non-heat-source) plutonium processing. Table VII lists all of the

source and matrix combinations that will be tested in all the PDP cycles. It also lists the initial cycle tests consisting of the empty and benign matrix drums. Table VII also lists the order in which the tests will be conducted during the PDP.

The result of this effort is the complete PDP test program including general specifications for the matrix drum types and the source standards. These results will be presented to the WIPP Interface Working Group and others for review. The final program will be included in the PDP document.

**Add-A-Source Lifecycle Technology Transfer in Support of Cooperative Research and Development Agreement (CRADA) Activities (Mark M. Pickrell, NIS-5).** We continued our efforts to commercialize safeguards technology through two CRADAs. The first CRADA, with Canberra Industries, Inc., was instituted at the start of this year and is under way. This CRADA is developing the next generation of passive neutron counters to assay TRU waste. The new counters provide both an accurate characterization of the TRU waste and also a robust

**Table VII. Source and Matrix Drum Combinations and Order of Testing**

Matrix Number	Matrix Type	WG Pu	HEU	Am/Pu	Particle	Heat Source
1	Empty	X	X	X	X	X
2	Benign/Ethafoam	X	X	X	X	X
3	Combustibles	X	X	X	X	X
4	Sol. Inorg. Sludge	X	X	X	X	
5	Glass	X	X			
6	Solid Organ. Sludge	X	X	X	X	
7	Metals	X	X	X		
8	Heterogeneous	X	X	X		

way to determine if safeguards can be terminated. The second CRADA is in the final stages of approval and is a joint effort between Los Alamos and Reuter Stokes, Inc. This CRADA will develop advanced neutron detectors for use in high-gamma-ray fields.

The CRADA with Canberra is jointly developing an advanced passive neutron counter to measure waste drums destined for the WIPP site. This system will be tested under the auspices of the WIPP PDP. Based on our current research, we believe the new Add-A-Source passive neutron counter will perform well under PDP test. In addition, this instrument will have modern features such as full multiplicity capability, segmented add-a-source, and a very-high-efficiency (nominally 40%) neutron detector. These features will enable this machine to serve for safeguards termination. The multiplicity feature can detect the presence of shielded plutonium. The very high-efficiency and low-background features make the machine attractive to overseas customers, such as the Japanese.

This machine is being constructed at the Canberra Industries, Inc., plant in Meriden, Connecticut. Los Alamos contributed the design of the neutron detector. A figure of merit for the detector design was developed at Los Alamos to optimize the counter for very low levels of detection and the multiplicity capability. The result was that the detector was optimized to have a high efficiency, a short die-away time, and a small cross section to reduce the cosmic ray background level. Extensive MCNP design resulted in a nominal 40% efficient detector, a 60- $\mu$ s die-away time, and a small cross section (only a single row of helium-3 detector tubes is used).

A second CRADA is being pursued with Reuter-Stokes, Inc. Reuter-Stokes manufactures helium-3 detector tubes that are the foundation for neutron NDA instruments for both safeguards and waste applications. New safeguards applications, such as the measurement of spent fuel, require reliable operation

in high-gamma-ray environments. Present neutron detector tubes suffer from gamma-ray interference with the neutron measurement. In addition, after protracted exposure, these tubes cease to operate. The joint Reuter-Stokes/Los Alamos research will develop a new generation of tubes that are resistant to gamma-ray damage, so that they can operate reliably in a continuous, high-fluence, gamma-ray environment. In addition, these tubes will be optimized to reduce the gamma-ray interference with the neutron detection. This CRADA is in the final stages of approval.

**Combined Neutron Gamma Lifecycle (Mark M. Pickrell, NIS-5).** We continue to make progress on the combined neutron gamma lifecycle. There are two areas of effort to report. The first is the design and construction of a combined shuffler and add-a-source neutron counter. This instrument is presently in construction. It has been designed to commercial standards, so that it will also function as training equipment for the waste assay school also under development. The research purpose of this instrument is to assay 200-L drums using the most effective active and passive neutron methods available. The most effective active neutron instrument is the californium shuffler. The most effective passive neutron instrument is the passive add-a-source. These are being combined into a single instrument. Moreover, recent advances under the auspices of the add-a-source lifecycle and CRADA with Canberra Industries will be exploited. The second recent accomplishment is the acquisition of the entire INEL calibration assay database. This database will be used for initial data-fusion studies using the Alternating Conditional Expectation (ACE) algorithm. ACE has already been applied successfully to the analysis of shuffler assay data.

The new combined add-a-source/shuffler counter will be used to demonstrate passive neutron assay with the segmented add-a-source feature to students in the waste assay school. The

unit is being built in a shielded cell to save costs, however, it will be built to commercial standards. For the research application, the machine will also be a functional shuffler. Test drums can be measured using either the shuffler or add-a-source capabilities or both. In our experimental plan, we intend to measure a set of test drums using this combined machine and also the TGS, which is the most advanced gamma-ray instrument available. Our plan is to develop an extensive data set of combined measurements (TGS, shuffler, passive neutron add-a-source) that can be analyzed and exploited for data combination methods.

The first method tried will be the ACE algorithm, which was applied successfully on a large (nearly 2,000 drum) set of shuffler data. We are applying the ACE method to the INEL data set, which is the second phase of our study. The INEL data is extensive but uses instruments not as advanced as the TGS or add-a-source. However, it should provide extensive insights into the possibilities for data fusion. The final stage will be the development of the combined data set using the add-a-source, shuffler, and TGS, and the subsequent analysis of this data using the ACE technique. We also plan to try other data-fusion methods on this data.

The new combined add-a-source/shuffler, which is an upgrade to a previous instrument, is presently under construction. It is on schedule and budget.

**Integrated SGS/Isotopics/Peak Search & ID (G. A. Sheppard, T. E. Sampson, T. A. Kelley, R. A. Cole, and J. D. Fryar, NIS-5).** With careful software design and implementation, we have combined the NDA functions of segmented gamma-ray scanning and isotopic composition determination on a single measurement system. We are working to minimize the *a priori* knowledge of a nuclear material sample that a measurement technician must have by incorporating automated gamma-ray-peak search and identification functions into the SGS.

## Introduction

The SGS measures gamma rays emitted by the radioactive contents of subvolumes of a container and applies an attenuation correction based on the measured transmission of gamma rays from an external source. It is widely used to determine the masses of gamma-ray-emitting isotopes in containers of low-density materials. For many of these same containers, it is important to determine the contents' isotopic composition as well. Traditionally, a separate instrument system has been used to scan a container past a collimated high-resolution gamma-ray detector, acquire a gamma-ray spectrum, and reduce the data to yield relative isotopic compositions. The isotopics system developed at Los Alamos is called FRAM. With the appropriate software to control sample motion and to acquire and analyze the gamma-ray spectral data, an SGS should be able to determine isotopic compositions as well as masses.

## Integration of SGS and Isotopics Systems

We converted our SGS and FRAM isotopics software packages from the VAX/VMS operating environment to the Microsoft® Windows™ system. As we did so, we incorporated features in both that are complementary. PC-SGS, for instance, is capable of summing the emission spectra from all the sample segments and writing it to a file readable by PC-FRAM. Then PC-FRAM can read and analyze the spectrum file, producing a report of its results. Alternatively, PC-FRAM can control the sample scan on the SGS system and acquire and analyze the data directly. Both use a graphical user interface that features a common look and feel for the operator. Either program can be invoked by selecting the appropriate icon using the mouse pointer and clicking the mouse button. The facility with which a user can switch between programs, coupled with the complementary features built into them, obviates the need to integrate PC-SGS and PC-FRAM

within a single large program. Instead, the two techniques were integrated by using shared hardware and a common operating system.

## Peak Search and Identification

A limitation of current SGS software is that no peak search is performed and no isotopes are identified. Therefore, the user must determine *a priori* the isotopes for which assays are required and then set up the appropriate regions of interest in the gamma-ray spectrum. To eliminate the requirement that the isotope identities be known before the assay begins, we are developing an automatic peak search and identification capability for the SGS.

We have prepared a Software Requirements Specification to guide the implementation of this new SGS analysis feature. When integrated with existing SGS software, the following protocol will be followed automatically:

- Most spectral data reduction will be deferred until transmission and emission gamma-ray energy spectra have been obtained for all segments in the sample. Segment spectral files will be temporarily stored until analysis is completed later.
- The gamma-ray energy spectrum obtained by summing the passive spectra from all sample segments will be automatically searched for peaks.
- The energies of statistically significant peaks will be compared to a library containing isotope, energy, and relative intensity data for a selected suite of gamma-ray lines.
- All peak finds, both identified and unidentified, will be reported to the user.
- Using conventional SGS algorithms, stored segment data will be analyzed to obtain the correct count rates of the found peaks.
- For isotopes for which calibrations exist, the corrected rates will be converted to isotope mass and reported in grams. In the absence of isotope mass calibrations, results will be

reported in terms of counts per second.

- At the user's option, the stored segment spectra can be automatically deleted when the assay is complete.

Because gamma-ray libraries available commercially and from research institutes contain far more data than is routinely applicable at facilities that employ SGS systems, we will prepare an easily editable file containing appropriate data for only the isotopes that can reasonably be expected to appear. We have evaluated the option of interfacing with commercial software packages that perform peak search and identification functions and found it to be impractical due to their inaccessibility from our SGS software and due to the difficulty of writing different calling routines for each commercial product. We have not ruled out the option of using existing routines that may be available either from other laboratories or from vendors of such products.

## NDA Technology Exchange and Implementation (N. Ensslin, NIS-5).

The NDA Technology Exchange and Implementation Project supports transfer and implementation of Office of Safeguards and Security (OSS) NDA technology to DOE facilities through assistance, consultation, ad hoc training, and informal technical meetings. During this past year, we provided support to DOE nuclear materials facilities in such areas as holdup measurements, inventory verification, implementation of neutron multiplicity counting, and IAEA inspections of excess weapons materials. Throughout the year, we also transferred OSS-developed technology to the safeguards community and to commercial vendors through Neutron Users Group, WIPP NDA/NDE Working Group, and Radiation Detection Panel meetings.

This project provides a focal point for transfer of integrated safeguards technologies to DOE processing, dismantlement, and storage facilities. This activity supports guidance, assistance,

and ad hoc training to assure that technology developed through the OSS safeguards research and development program is successfully implemented at DOE sites. Current activities include providing ongoing support to DOE facilities on I&E audit requirements such as closure on previously unmeasured inventory; on receipts measurements of weapons materials; on residue, waste, and holdup measurements; and on IAEA inspections of excess U.S. weapons materials. We also provided support for the Neutron Users Group and the WIPP NDA/NDE Interface Working Group. The project provides support for materials control and accountability (MC&A) personnel at all DOE facilities that handle SNM and leads to improved cost effectiveness and operational efficiency. Major activities during FY95 are summarized below.

### **Savannah River FB-Line Restart**

We worked with the Savannah River DOE MC&A Office and FB-Line safeguards personnel to upgrade NDA measurement capability at the FB-Line in preparation for restart. We provided consultation, loaned NDA equipment for rapid inventory verification of vault materials by neutron coincidence counting, recommended upgrades to the facility's isotopic analysis capability in support of calorimetry and neutron counting, and then quickly provided a new FRAM analysis system with matching facility funding. We also met with DOE and spent-fuel storage facility personnel to develop options for underwater assay of spent highly enriched research reactor fuel.

### **Neutron Users Group Meetings**

The Neutron Users Group provides a forum for exchanging information on neutron NDA techniques and needs. Two Neutron Users Group meetings were held this year with safeguards instrumentation developers, neutron instrument users, and representatives of commercial companies.

In January, we conducted a workshop on calibration standards for waste assay in conjunction with the winter meeting of ASTM Sub-Committee C26.10 in Phoenix, Arizona. The workshop focused on waste drum standards characterization, fabrication, and performance, which was of interest to many of the safeguards and waste assay personnel on this ASTM committee. After the regular Users Group meeting, a second meeting was held that evening to provide a workshop on the new neutron multiplicity measurement technique for the committee members.

In July, we held a Neutron Users Group meeting at the annual Institute for Nuclear Materials Management (INMM) Meeting in Palm Desert, California. The meeting consisted of a workshop on measurement uncertainty with five presentations on measurement uncertainty topics and field experience. The workshop format seems to be an effective way to concentrate the Neutron Users Group meeting on a single topic that is important to most attendees.

### **Radiation Detection Panel Meeting**

On behalf of the OSS Technology Development Branch, a member of the Los Alamos Safeguards Program attended the May meeting of the DOE Radiation Detection Panel, chaired by Mike O'Connell of NN-21, to give a briefing on the OSS Technology Development Program. This briefing emphasized OSS measurement technology development roles and drivers and some general requirements for NN-21 technology development that would benefit OSS. During the past year, we also provided information on OSS-developed technology for the Office of Research and Development's report on "Fieldable Nuclear Detection Technology."

### **Support to Portsmouth on Uranium Solution Assay**

We provided support to the Portsmouth Gaseous Diffusion Plant on

calibration and certification of the Solution Enrichment Systems that Los Alamos provided several years ago. These state-of-the-art systems employ transmission-corrected gamma-ray assay with x-ray fluorescence to determine uranium enrichment and concentration using a robot-operated sample handling and identification system. Los Alamos staff traveled to Portsmouth to install amended software on both systems, help recalibrate one of the systems, and consult on operation and maintenance issues.

### **Interactions with Rocky Flats**

The Rocky Flats Safeguards Measurements Group has established an NDA Assessment Team to identify NDA measurement needs at Rocky Flats for in-line and at-line measurements of processing residues, scrap, and waste items. Los Alamos safeguards measurement staff reviewed NDA options and recommendations for measurement of the residues in the current Rocky Flats inventory, with additional funding from Rocky Flats.

During the past year, Rocky Flats obtained a large 30-gal. neutron multiplicity counter for use in inventory verification, residue assay, and IAEA inspections of excess weapons materials. We calibrated this instrument and provided a specialized neutron multiplicity workshop. The workshop described the principles and features of neutron multiplicity counting in detail, as it applies to a wide variety of nuclear materials.

### **Interactions with the Livermore Nuclear Materials Facility**

We continued to interact with the Livermore MC&A organization, which has acquired several state-of-the-art NDA instruments for inventory verification measurements: an AWCC, a californium shuffler for high-density waste drums, and a 30-gal.-drum neutron multiplicity counter from Los Alamos for large plutonium items. We provided calibration support for some



of these instruments, and conducted a neutron multiplicity workshop at Livermore in November. The workshop described the principles and features of neutron multiplicity counting and focused on verification measurements of bulk plutonium and uranium samples.

### **WIPP NDA/NDE Working Group Meetings**

During this past year, several members of the Los Alamos Safeguards Program attended the WIPP NDA/NDE Interface Working Group meetings in Carlsbad, Livermore, and Salt Lake City. The Carlsbad meeting was hosted by the DOE Carlsbad Area Office and the Westinghouse Waste Isolation Division under the National Transuranic Program Office. Los Alamos attendees gave a number of technical presentations on OSS technology development activities that address the safeguards and security issues associated with the measurement of radioactive wastes and residue materials. Many of these OSS-supported technologies (such as the Hybrid SGS/TGS CTEN Assay System, the Add-a-Source Waste Drum Assay System, and the Californium Shuffler) also support waste characterization issues associated with WIPP waste acceptance criteria. The meeting also provided an excellent opportunity to provide information about the OSS Safeguards Technology Training Program and to obtain feedback on the new Waste and Residue NDA Measurements seminar that we are developing.

### **Los Alamos Plutonium Facility**

Representatives from the Los Alamos nuclear safeguards groups met with safeguards personnel from the Los Alamos Plutonium Facility to evaluate facility monitoring and nuclear materials accounting needs for the Nuclear Materials Storage Facility. We will provide support on monitoring of storage locations to reduce inventory frequency, NDA of shipper/receiver activities,

verification of items going into storage, and long-term monitoring of stored materials for stability.

### **Fissile Materials Assurance Working Group**

With additional support from the DOE Office of Security Evaluations, we provided technical data, figure illustrations, and technical consultation for the DOE report on "Increasing Fissile Inventory Assurance within the U.S. Department of Energy." Areas of discussion have included NDA measurement methods and their accuracy, measurement techniques for scrap materials, and hardware and software dissemination and standardization issues. The Los Alamos safeguards software development team provided a recommended procedure for disseminating and standardizing NDA software throughout the complex and will conduct a trial implementation with the new Windows-based neutron coincidence counting code during FY 1996.

### **Support for Holdup and Waste Assay Activities at Y-12**

At Y-12, we reviewed an Oak Ridge proposal to construct calibration materials for gamma-ray-based measurements of waste in 4-ft × 4-ft × 6-ft boxes or 55-gal. drums. The calibration materials will be constructed in a modular fashion to allow minimal amounts of SNM to be used. We continue to work with Y-12 count room personnel on active multiplicity measurements, and we have analyzed an initial set of data received from Y-12 on skull oxide containers, an important SNM category at Y-12.

Los Alamos also continued to interact with Y-12 on holdup measurements, neutron and gamma-ray screening of waste in B-25 burial boxes, and on possible AWCC measurements of Project Sapphire materials at Babcock & Wilcox, Lynchburg. We have also received matching facility funding to support the Y-12 waste packaging and

certification facility on evaluation and integration of NDA techniques for assay of 55-gal. drums and B-25 boxes.

### **INEL NDA Study**

We completed a conceptual design study for holdup and active neutron measurements of Rover fuel at INEL both *in situ* and after removal and packaging into containers. We also provided the facility with cost estimates on implementation of a 55-gal. californium shuffler to carry out these measurements.

### **Support to Hanford on IAEA Excess Weapons Materials Inspections**

During the past year, the Los Alamos Safeguards Program provided support to Hanford on the IAEA inspections of their excess weapons materials in December 1994 and August 1995. We provided procurement specifications for instruments, shipped a prototype three-ring multiplicity counter to Hanford on short-term loan, and provided help with calibration and data analysis.

**Field Test and Evaluation of Tomographic Gamma Scanning (T. H. Prettyman, G. A. Sheppard, NIS-5; N. J. Nicholas, R. J. Estep, M. C. Lucas, NIS-6; S. E. Betts, D. P. Taggart, and R. A. Harlan, Kaiser Hill Company, Rocky Flats Environmental Technology Site).** During the past fiscal year, Los Alamos completed the construction of a mobile TGS intended primarily for use by the Laboratory's Environmental Management Program (Fig. 15). The mobile system contains a tomographic gamma scanner that is capable of assaying samples ranging in size from 2-ft<sup>3</sup> boxes to 83-gal. overpacks using a variety of scanning protocols, including tomographic and segmented gamma scanning. The scanner is staged in a well-engineered trailer that is roughly 24 ft in length and includes a shielded control room and a

heating, ventilation, and air conditioning system.<sup>23,24</sup> Power is provided via a portable diesel generator. A fully automated drum loading system is provided to enable safe and efficient drum handling. An external interface is provided so that the system can be controlled and monitored from a remote location, enabling the examination of RH-TRU waste.

Shortly after its completion, the mobile system was demonstrated at RFETS.<sup>23,24</sup> During the week-long demonstration during the last week of March, 12 residue drums were assayed. Residue included electrorefining salts, resins, crucibles, Raschig rings, and heavy-metal filaments. Based on the declared inventory values, the amount of Pu-239 in the drums ranged from 10 g to 650 g. The inventory values of three of the drums had been established by Rocky Flats using calorimetry and were used to test TGS accuracy. During the Rocky Flats demonstration and for all of the assays described in this report, the standard TGS scanning protocol was used:

- 1-hour total scan time,
- 2.25-in. resolution (10×10 image elements per axial segment),
- 16 axial segments,
- 150 scan points per segment (2400 scan points total, ~6/10 sec per point), and
- continuous rotation and translation of the sample.

Images of the 12 Rocky Flats residue drums obtained using this scanning protocol are presented in Fig. 16. The distribution of emitting and attenuating material within the drums was found to vary widely and in most cases was nonuniform.

Immediately following the demonstration, a joint exercise involving Rocky Flats and Los Alamos was carried out to further test the performance of TGS.<sup>23,24</sup> In the follow-on evaluation, residue drums were simulated using matrix material and SNM sources available at Los Alamos. The simulated residue drums were then assayed by the mobile TGS. Residue categories included Raschig rings, scrap metal, pyrochemical salts, and wet combustibles.

SGS plutonium standards were used to test the effect of matrix composition on the accuracy of TGS assays. Self-attenuating standards were used to test the ability of TGS to detect and correct for lumps.

In the summer, the mobile system was used to assay TRU waste at the Los Alamos TRU waste storage site (Area G). To test the accuracy of the system for TRU waste assay, a number of waste drums were identified that had been assigned Pu-239 inventory values by assaying the individual packages before they were loaded into drums. Because the bias due to matrix interference is reduced in small samples, small-sample SGS results were used to establish a reference Pu-239 mass for each drum. Most of the drums available for the study were found to have Pu-239 masses near the 200 FGE cutoff for TRU and contained medium-density matrices ( $\rho_{\text{bulk}} > 0.3 \text{ g/cm}^3$ ).

The declared Pu-239 mass and the mass of Pu-239 determined by TGS for Rocky Flats residues, simulated residues, and TRU waste are compared in Fig. 17.

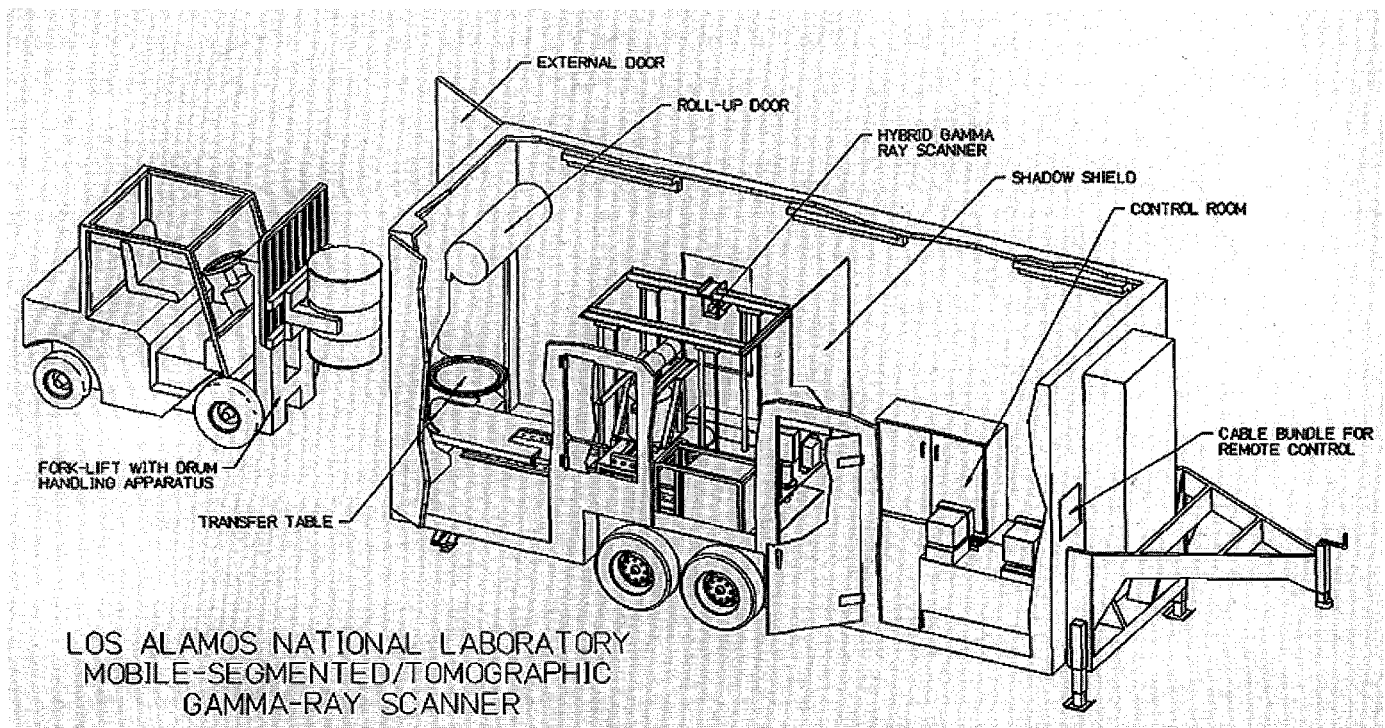

Fig. 15. Diagram of the mobile tomographic gamma scanner.

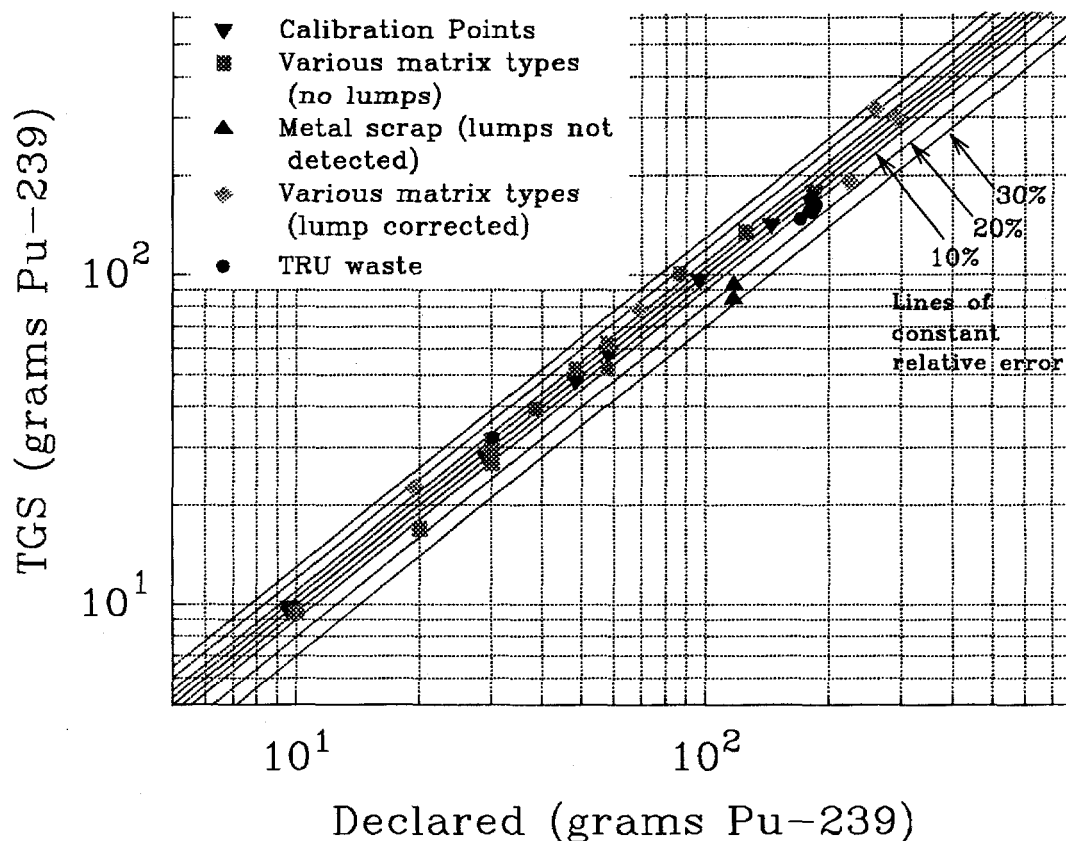

Fig. 16. TGS results for residues, TRU waste, and mock-ups.

Results for 48 drums are shown. Several drums that contain no matrix material, referred to as calibration points on the chart, are included in the data set. Lines of constant relative error ( $\pm 5\%$ ,  $\pm 10\%$ ,  $\pm 20\%$ , and  $\pm 30\%$ ) are provided to help the reader visualize the magnitude of the bias. The inventory difference was  $-2\%$  and most of the TGS assay results were within  $10\%$  of the reference values.

The maximum bias observed was  $-27\%$  corresponding to a simulated residue drum that contained self-shielded plutonium standards mixed with aluminum and iron metal scrap ( $\rho_{\text{bulk}} > 2 \text{ g/cm}^3$ ). For drums with dense matrices, including Raschig rings and metal scrap, the average magnitude of the bias of assays based on the 414-keV line was found to be  $10\%$  when lumps were not present. The ability to detect self-shielded material in dense matrices is limited because the lower-energy plutonium lines are highly attenuated. For medium density matrices, such

as pyrochemical salts, lumps can be detected and reliable corrections can usually be made. For the Rocky Flats drums containing electrorefining salts, the lump correction algorithm was able to correct the TGS assay to within  $3\%$  of the reference values, resulting in nearly a  $30\%$  reduction in bias.

By collapsing the TGS data set to produce a single scan point per segment and assuming each segment was uniform, equivalent SGS assays of the high-density drums were simulated. In nearly all cases, the equivalent SGS assays were found to be biased low by nearly a factor of five. The large negative bias observed for SGS was caused by the placement of the SNM standards near the center of each drum. It is worth noting that the comparison between SGS and TGS described here is favorable to SGS because the SGS transmission measurements are usually measured through the center of the drum, whereas

TGS data used to simulate SGS included measurements through the edge of the drum where the transmission is higher.

In conclusion, the initial field test and evaluation (T&E) was successful in providing data on TGS performance for a wide range of matrix materials and SNM loadings. Based on the performance of TGS established in this study, TGS is an effective and reliable tool that can be applied to residue stabilization and waste management and represents a significant improvement over existing gamma-ray instrumentation. The performance of TGS is comparable to passive neutron counting for metals and for matrices that cannot ordinarily be assayed by conventional gamma-ray methods. Lump-corrected TGS can serve as a complementary technique to passive neutron counting for pyrochemical salts where high ( $\alpha, n$ ) backgrounds can cause unacceptable bias in assays using passive neutron counting.

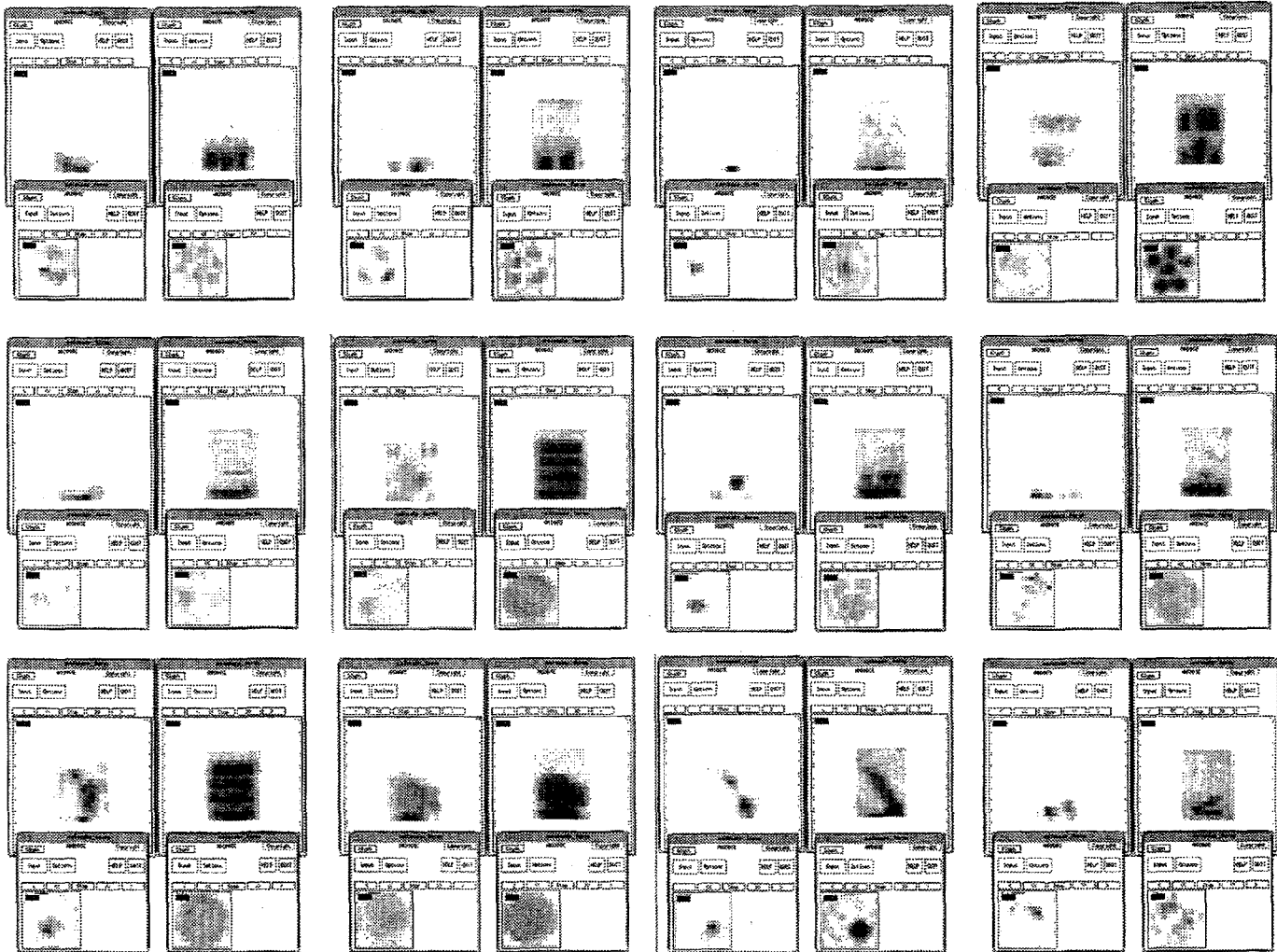

*Fig. 17. TGS images of Rocky Flats residue drums. For each drum, the distribution of Pu-239 (emission) and the distribution of attenuating material (matrix) are displayed as side-view radiographs (upper left and upper right, respectively). In addition, tomographs of the emission and attenuation distributions are displayed for a selected section of each drum (lower left and lower right, respectively).*

Further T&E will occur during the next fiscal year using the prototype TGS at the Los Alamos Plutonium Processing Facility (PF-4), where we will have access to a variety of plutonium samples, including pyrochemical salts. In this exercise, the performance of the prototype TGS will be compared with calorimetry, passive neutron counting, and multiplicity counting. This T&E is expected to provide an exhaustive study of TGS performance for self-attenuating materials and will result in valuable data needed to determine how TGS should be integrated with other NDA instrument concepts in MC&A

and waste assay systems. TGS technology is being developed by OSS primarily for safeguards, but with application to environmental management.<sup>25-28</sup>

**Tomographic Gamma Scanning: Overview (T. H. Prettyman, G. A. Sheppard, NIS-5; and R. J. Estep, NIS-6).** Tomographic gamma scanning is an advanced NDA technique that is being developed by the Los Alamos Safeguards program to assay gamma-ray emitting radionuclides in large samples, such as 208-L drums, with high accuracy.<sup>29</sup> An important application of TGS is the termination of safeguards

on waste material, where the accuracy of TGS could reduce the risk of diversion in waste and the associated costs for storage and repackaging. In addition, TGS is the only gamma-ray-based NDA technique that can accurately assay dense, inhomogeneous samples. As a result, TGS complements passive neutron counting, enabling a wider range of samples, including pyrochemical salts, to be assayed. TGS can also be applied to assay heterogeneous TRU waste. For this purpose, we have developed a mobile TGS system that is currently in operation at Los Alamos TRU waste storage sites.<sup>30,24</sup>

TGS combines both gamma-ray transmission and emission imaging modes to quantify gamma-ray emitting material within a sample (Fig. 18). With transmission computerized tomography (CT), three-dimensional images of the gamma-ray attenuation coefficient are reconstructed at selected energies from gamma-ray transmission data obtained using an isotopic source (e.g., Se-75). This information is used to estimate the attenuation of gamma rays of arbitrary energy emitted at any location in the sample. Emission CT, corrected for attenuation by matrix materials, provides the location and quantity of gamma-ray-emitting material.

TGS systems employ high-resolution gamma-ray spectroscopy (HRGS) to measure the intensity of individual gamma-ray lines in the complex gamma-ray spectra emitted by SNM. HRGS is extremely important in safeguards and environmental applications because decay products and contaminants (e.g., Np-237 and Am-241 in plutonium residues) often contribute significantly to the observed gamma-ray spectrum. The ability provided by HRGS to identify gamma-ray-emitting isotopes other than Pu-239 and U-235 is important in both safeguards and environmental settings. In addition, the variation of gamma-ray attenuation with energy can be used to detect self-shielding in material containing isotopes that emit multiple-energy gamma rays. This feature is important for the safeguards termination problem and has been used to identify and correct for self-shielded plutonium.<sup>31,32</sup>

The images of a 208-L drum containing plutonium residues shown in Fig. 19 were reconstructed from TGS data. The images are coarse; each side of an image volume element (or voxel) is roughly 2.25 in. in length, and the volume of a 208-L drum is typically divided into roughly 1600 elements. Despite the coarseness of the images, internal structural details, including individual packages, of the sample can clearly be resolved. The section view is a composite of both the emission (Pu-239,

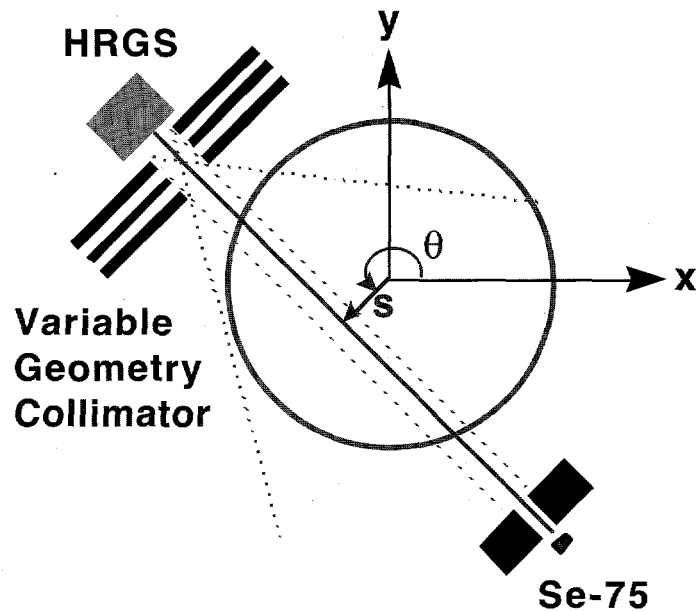

Fig. 18. TGS concept drawing.

414 keV) and attenuation images. The rendering format enables contaminated packages to be identified.

The low-resolution imaging mode was selected to accomplish the primary task of quantifying gamma-ray-emitting material while adhering to strict facility throughput requirements.<sup>33</sup> TGS scans are restricted to less than 1 hour for a two-pass assay, in which the transmission and emission measurements are collected in separate scans. Despite the time limitation, a single detector system can assay Pu-239 and other gamma-ray

emitting materials (such as U-235) in samples with matrix densities  $>1 \text{ g/cm}^3$  with high accuracy, typically better than 10%, with a sensitivity equivalent to that achieved by conventional SGS instruments. The accuracy improvement provided by TGS enables accurate gamma-ray assays for an extended range of sample categories, including pyrochemical salts and dense matrix materials such as scrap metal.

TGS performs well because of its experimental design and the use of analytical techniques that perform well

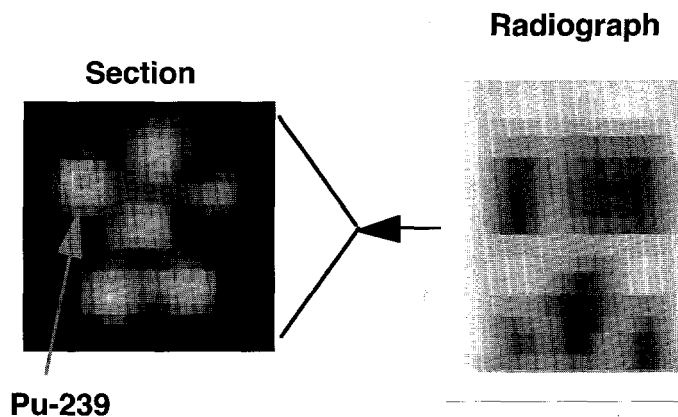

Fig. 19. Reconstructed images of a 208-L drum containing plutonium residues.

when count rates are low. For example, to reduce overhead, we use a continuous scanning protocol instead of the traditional start-stop scanning technique of first-generation CT. In a low-resolution scan of a 208-L drum, gamma-ray-peak region of interest (ROI) data is recorded from the HRGS measurements at 150 individual points in displacement-angle space (Radon space) for each axial layer. Usually, 16 axial layers are used, resulting in a total of 2400 discrete scan locations, with a dwell time of 0.6 s per location. Analysis techniques have been developed that account for the non-ideal sampling of Radon space that is unique to this protocol.

During the past fiscal year, significant effort has gone into developing techniques to analyze and model TGS data. This work has resulted in a number of innovations in both transmission and emission CT. For example, a new class of emission reconstruction algorithms has been developed to account for the statistical structure of HRGS measurements.<sup>27,34</sup> We have developed robust transmission reconstruction algorithms that function reliably even if a significant portion of the transmission data set is missing (e.g., when the center of the drum is nearly opaque to transmission gamma rays)<sup>35</sup> and fast techniques for energy-interpolation.<sup>28</sup> We have also developed a computationally efficient technique to estimate the variance of regions-of-interest in constrained emission tomographs, which can be applied to general medical and industrial imaging problems.<sup>36</sup>

Central to our analytical capability is the TCNDA code (for Transmission-Corrected Gamma-Ray NDA), currently a UNIX-based modeling and analysis code that is being applied to study variable resolution TGS, SGS, and other scanning protocols.<sup>37</sup> Analysis modules have been developed for each step in the process of determining SNM mass from TGS data:

1. interpolation of measured gamma-ray transmissions to determine transmissions at each emission gamma-ray energy,
2. reconstruction of attenuation images at each emission gamma-ray energy,
3. reconstruction of emission images with a correction for sample attenuation,
4. correction for source self-shielding effects and the calculation of mass, and
5. estimation of the statistical variance of the assay.

TCNDA can also model emission and transmission CT data in detail and is useful for evaluating the performance of new analytical techniques and scanner designs and for investigating sources of bias in gamma-ray assays.<sup>38</sup>

While TGS is currently used in low-resolution mode, future work will focus on merging medium-to-high-resolution CT and radiography (both real-time and digital) with HRGS-based TGS measurements to improve accuracy and enhance visualization. As the first step in this process, we constructed a variable-geometry detector collimator to enable medium resolution region-of-interest imaging and variable resolution TGS scans. We are developing an experimental linear detector array and analytical techniques to merge linear array data with HRGS.

We are also researching a promising new class of reconstruction algorithms that will enable higher-resolution images (e.g., 1-in. volume elements) to be acquired using the existing single-detector prototype TGS without sacrificing assay precision or throughput. The goal is to obtain the highest accuracy possible, given the data and precision/throughput limitations specified by the user. The new reconstruction algorithms will force image resolution to vary to compensate for the statistical quality of the measurements. Using this technique, images of samples in which large quantities of emitting material are present will be obtained with full resolution. When small quantities of material are present, image resolution will be reduced until a preset statistical threshold is achieved. The limiting case involves

the reduction of the image to a single volume element and is equivalent to segmented gamma scanning. The challenge in this work is achieving optimal compression of the reconstructed image and the emission or transmission data set. We have already had some success in solving this problem for Radon-space compression of transmission CT data. Our research is currently focused on penalized optimization techniques, which are simple to implement and can be applied to both the image and the data.

**MC&A Technology Training (H. A. Smith, NIS-5).** The DOE MC&A Training Program is a major vehicle for technology transfer to both the U.S. and international safeguards practitioners. This training program has evolved over more than two decades to include lecture courses on general MC&A and safeguards systems methodology and hands-on laboratory courses that illustrate measurement techniques and instrumentation with nuclear material samples similar to those found in operating facilities. The curriculum now includes eight formal seminar offerings and special lecture series and has serviced more than 2700 students. The program informs participants of the latest nuclear material control and measurement technology and keeps the Los Alamos Safeguards Research and Development personnel abreast of the needs and experiences of facility operators and safeguards inspectors. Students from DOE facilities are given first preference for attendance at all courses. Other students (for example, people from non-DOE facilities and foreign students) are accommodated if space is available. Separate courses are given to support the training needs of the IAEA and other international customers. The training program enjoys an excellent reputation throughout the domestic and international nuclear communities.

This year, our domestic training program consisted of five seminars, development efforts on additional modules

of the "NDA Techniques for Safeguards Practitioners" seminar, further development of the "Waste and Residue NDA Measurement" seminar, and participation on development teams and as instructors for MC&A courses at the Central Training Academy (CTA).

**Los Alamos/DOE Safeguards Technology Training Program (H. A. Smith, P. A. Russo, NIS-5; and D. Wilkey, NIS-7)**

The attendance at the five seminars presented at Los Alamos is summarized in Table VIII.

**Seminar on NDA Techniques for Safeguards Practitioners**

The Los Alamos Safeguards Science and Technology Group presented back-to-back offerings of the five-day seminar on NDA Techniques for Safeguards Practitioners on September 11–15 and 18–22, 1995, to 55 students from 20 facilities. This course continues to elicit the highest and most aggressive demand, which is backlogged with a waiting list of about 80 applicants. The two consecutive offerings allowed a higher rate of service to our large waiting list with minimal cost impact. This seminar, formerly titled the "Fundamentals of NDA," provided detailed hands-on instruction in the use of gamma-ray and neutron NDA instrumentation for DOE safeguards personnel who perform nuclear material NDA measurements in their facilities. Curriculum upgrades for these offerings of the seminar emphasized the neutron laboratories, with the addition of some instructional material on neutron multiplicity counting.

**Seminar on Measurement of In-Plant Nuclear Material Holdup**

The DOE-sponsored seminar entitled "Nondestructive Assay of Special Nuclear Materials Holdup" was presented at Los Alamos on July 25–27, 1995, to 20 attendees representing 9 facilities. The course included one half day of

introductory lectures, small-group hands-on measurements with portable NDA equipment, and "hands-on demonstrations" of upcoming technologies for automated portable NDA of holdup. The small-group-measurements portion of the holdup school involved calibration of compact, low-resolution gamma-ray (NaI) detectors for assays of uranium and plutonium holdup in generalized (point, line, or area) geometries, followed by measurement and quantitative assay of uranium and plutonium in simulated holdup exercises. The simulations were achieved with sealed uranium and plutonium reference materials inserted into piping, ducts, tanks, valves, and blenders (15 individual pieces of equipment with simulated holdup) in geometries similar to those of actual holdup deposits. All attendees performed the uranium and plutonium calibrations and measurements in two separate periods at two safeguards laboratory locations. The (NaI) calibrations, measurements, and quantitative assays were performed manually during these two periods. The "hands-on demonstration," scheduled between the uranium and plutonium measurement periods, let the attendees experience a practical solution to extending the laboratory problem to plant-wide proportions: namely, a thousand-fold expansion in the required scope of holdup determinations.

**Advanced Gamma-Ray NDA**

On June 26–29, 1995, Los Alamos hosted another offering of its Safeguards Technology Training Seminar on Advanced Gamma-Ray Techniques of Nondestructive Assay of Nuclear Materials for 24 students from 9 facilities. The subject matter of the seminar included high-resolution gamma-ray spectroscopy applied to transmission-corrected passive gamma-ray assay, uranium enrichment assay, and plutonium isotopic analysis. The course concluded with an in-depth demonstration of the tomographic scanning technique (with measurements of 200-L drums of

specially prepared SNM samples) and a lecture on the absorption-edge densitometry assay technique.

**MC&A Training Support to the CTA (T. Wenz and J. E. Stewart, NIS-5)**

In a continuation of effort begun in FY 1992, two Safeguards Assay Group staff members served as instructors for two CTA MC&A courses: "Basic MC&A Measurements" (MC&A 140) and "Basics of Measurement Control" (MC&A 144). Los Alamos served on the development teams for these courses in previous years and now provides adjunct faculty to help present the instructional materials. The Los Alamos Safeguards staff continue to assist in upgrades of these courses.

**Evaluation of the Integrated Holdup Measurement System with the M<sup>3</sup>CA for Assay of Uranium Holdup (P. A. Russo, J. K. Sprinkle, Jr., C. W. Bjork, G. A. Sheppard, NIS-5; and S. E. Smith, Lockheed-Martin Y-12).**

**Introduction**

Uranium holdup, simulated by inserting a variety of sealed uranium reference samples into pipes, ducts, and other hardware, has been measured for four consecutive years with an integrated holdup measurement system.<sup>39,40</sup> The result is a systematic evaluation of the generalized-geometry holdup (GGH) formalism applied to portable gamma-ray holdup measurements with low-resolution detectors. The four-year exercise was carried out both with and without automation of the measurements, data reduction/analysis, and holdup evaluation by the Hold-up Measurement System II (HMSII) software.<sup>41</sup> The extended exercise established reliable benchmarks for GGH measurements and documented the advantages of the automation with measurements. The results presented below demonstrate a factor-of-two improvement in the quantitative reliability of the holdup assay automated by HMSII. These and similar exercises also show that automation decreases, by a

**Table VIII. Summary of Attendance at Los Alamos/DOE Safeguards Technology Training Courses, FY 1995**

<b>Attendee Affiliation</b>	<b>Materials Accounting 3/13-17</b>	<b>Gamma-Ray Assay 6/26-29</b>	<b>In-Plant Holdup 7/25-27</b>	<b>NDA for S/G Practitioners 9/11-15</b>	<b>NDA for S/G Practitioners 9/18-22</b>	<b>Totals</b>
Babcock & Wilcox (Lynchburg)		1				1
Brookhaven National Lab					1	1
DOE (All field offices)	4	2	4	1	1	12
DOE Headquarters				1	2	3
EG&G (Idaho)			1			1
EG&G (WAMO, Maryland)		3			5	8
FERMCO, Cincinnati, OH			2			2
Gulf General Atomic	1					1
Lockheed Martin Idaho	1	1		1	1	4
Los Alamos (Pu Facility)	1	2		3	2	8
Los Alamos (Other areas)	4	4	4	7	5	24
MMES, Oak Ridge K-25	1			2		3
MMES, Oak Ridge Y-12	5	5	4			14
MMES, Piketon		3		1	2	6
New Brunswick Labs			2			2
U.S. NRC		3	1	2	2	8
ORNL	1			1	1	3
Pajarito Scientific				2		2
Pantex				1		1
Rock Mt. Remediation, Golden, CO			1			1
Sandia Labs, Albuquerque	1			2	2	5
Westinghouse Idaho		1				1
Westinghouse Savannah River				2	3	5
Korean Atomic Energy Research Inst			1	1	1	3
<b>TOTALS</b>	<b>19</b>	<b>25</b>	<b>20</b>	<b>27</b>	<b>28</b>	<b>119</b>



factor of 20 or more, the effort required to execute a holdup measurement campaign and obtain the holdup quantities for the facility.

### Equipment and Procedures

The systematic evaluation of the integrated holdup measurement system used the compact sodium iodide detectors<sup>42</sup> and both the Los Alamos M<sup>3</sup>CA<sup>43</sup> and the Davidson Corporation Portable Multichannel Analyzer (PMCA). The HMSII automated measurements were made with a palm-size, programmable barcode reader for operator interface with the hardware, automated setup and control of the portable gamma-ray spectroscopy system (M<sup>3</sup>CA or PMCA), and automated logging of the barcode and reduced measurement data associated with each measurement location. The simulated holdup in six equipment setups is illustrated in Fig. 20. Details of the equipment dimensions, uranium reference materials and their holdup reference values, and the alternative generalized geometries applicable to the GGH assay of the simulated deposits are given in Table IX.

The reference materials were loaded into the simulated process equipment for the holdup measurement tests with the GGH procedures once each year. Although the same reference materials were inserted each year, the precise locations within each piece of equipment changed. This is in contrast to the barcoded measurement locations for the HMSII-automated holdup measurements that were not moved from one year to the next.

The measurement procedures for the holdup measurement tests evolved from those used in the Los Alamos DOE-sponsored seminars on measurements of holdup. Two people (and sometimes only one for the HMSII-automated measurements, which can be carried out in all phases by only one person) composed each measurement team. Approximately 12 teams in a given year performed the holdup measurements in

the manual mode (using the PMCA with manual equipment setup, data acquisition, measurement control, selection of measurement geometry, record keeping, data analysis and computation of holdup in the extended equipment). These activities required approximately 1.5 working days (12 hours), excluding the time required to calibrate, and rarely did a measurement team complete all measurement exercises in this time period. Following the manual exercises, each measurement team (and in some cases, individual team members alone because the automated system is a one-user system) performed the same holdup measurements automated by the HMSII software. (The HMSII was used primarily with the M<sup>3</sup>CA with automated equipment setup, data acquisition, measurement control, selection of measurement geometry, record keeping, data analysis and computation of holdup in the extended equipment. The complete automated exercise required a total of approximately 20 minutes for setup, measurements, analysis, and computation with printed reports of measurement log information and equipment holdup results.

### Results

Figures 21 and 22 are graphs of three years of measurement results obtained by each of 12 groups per year. These groups consisted primarily of users who were inexperienced with the equipment and in holdup measurements. Plots of the individual assay results for the automated (Fig. 21) and manual (Fig. 22) measurements show reasonably good agreement, on average, with the reference values. This is also shown in Table X by the near-unity values of the ratios of the average <sup>235</sup>U-mass assay result to the reference value for each piece of equipment and the average (of the averages) for all equipment. However, the standard deviation in the ratio for manual measurements for each piece of equipment is about double that for the automated measurements. This is most apparent from the

dramatically larger swings in the data for each piece of equipment in Fig. 21 compared to Fig. 22.

### Conclusions

The large systematic effects in the results of the manual assays of holdup can be attributed to inconsistencies in the application of GGH procedures during the manual measurements and to less than optimum choices made in the manual reduction and analysis of the GGH data, despite written guidance. The systematic effects also reflect errors in transcribing results read out manually from the PMCA and errors that occur during the manual calculation of results. The reduced assay uncertainty (by a factor of 2 or more) from automation is combined with a reduction by more than a factor of 30 in the time required to carry out the holdup measurement campaign and obtain the final quantitative results. In addition to lower uncertainties and greatly reduced measurement time, the automated measurements can be performed by individual users whereas the manual measurements require at least two persons per measurement team to manage the more cumbersome equipment and data/procedure logging requirements. The benefits of the automated integrated holdup measurement system to the facility operator are most apparent in the results of these extended tests of the GGH capability with and without automation.

**Quantitative Verification of In-Process Inventory of High-Burnup Plutonium Using Room-Temperature Gamma-Ray Detectors and the GGH Formalism (P. A. Russo, M. C. Sumner, T. K. Li, H. O. Menlove, and T. R. Wenz, NIS-5).** Portable gamma-ray spectroscopy is a useful and powerful tool for verifying quantities of plutonium inventory deposited in process glove boxes and within process equipment. In several previous field exercises, in-process inventory and holdup of low-burnup<sup>44,45</sup> and high-burnup<sup>46</sup> plutonium

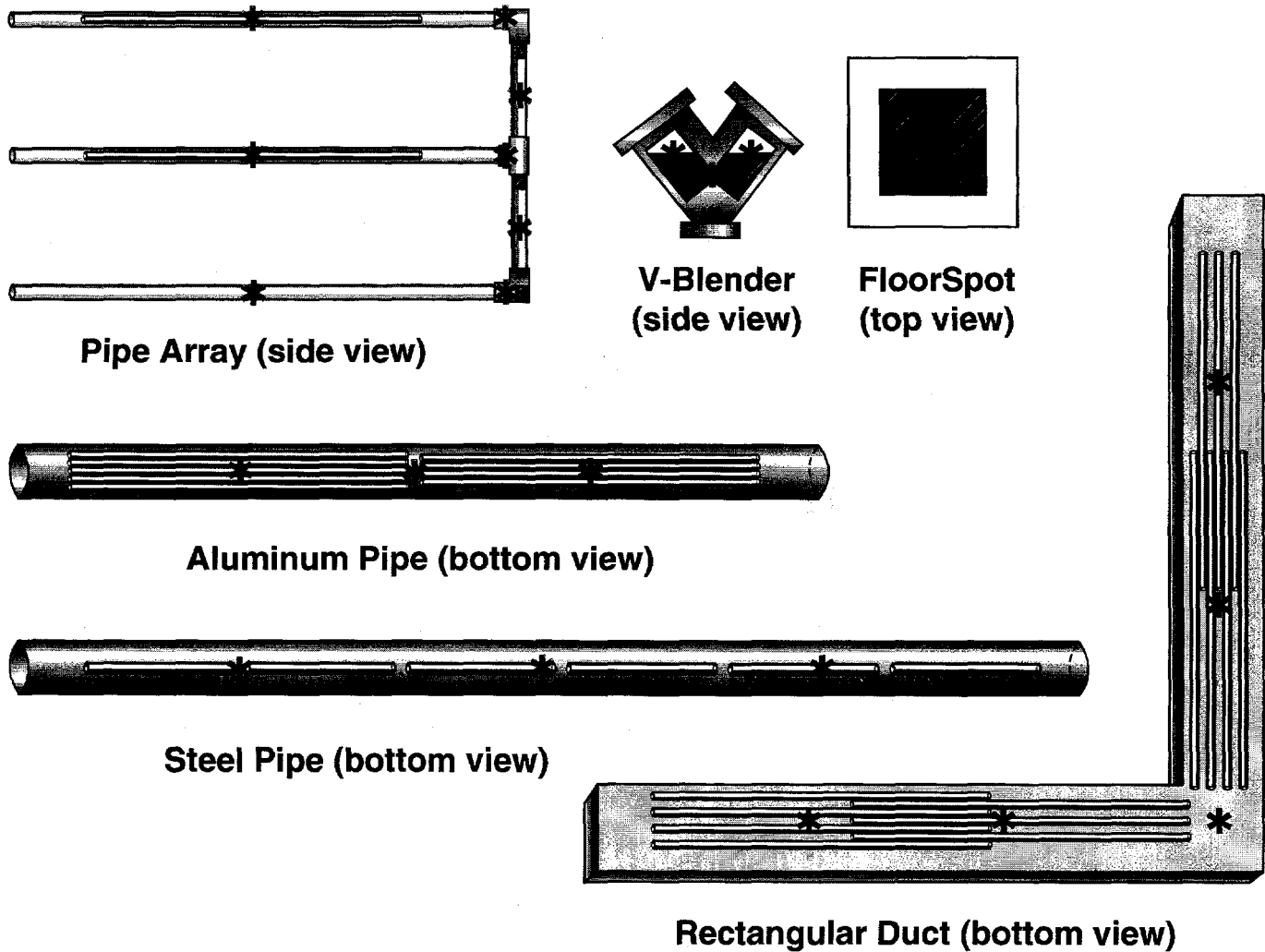

Fig. 20. The six pieces of simulated process equipment are shown approximately to scale with the uranium reference materials positioned within. The asterisks are the locations of the bar codes attached to the external surfaces of the equipment that are scanned prior to each HMSII-automated holdup measurement and indicate the measurement position to the user. Table IX gives the dimensions of each piece of equipment as well as details of the reference materials.

(LBU and HBU plutonium) has been quantitatively verified *in situ* using portable spectroscopy instruments, sodium iodide (NaI) detectors, and the GGH methodology and formalism<sup>47</sup> applied to the assay of the <sup>239</sup>Pu isotope. Agreement to ~25% with reference values is largely influenced by the uncertainties in the relatively large corrections that must be applied for several effects that are specific to these gamma-ray measurements. Reference values were determined in one case<sup>45</sup> by cleanout and assay of the recovered material; in one case<sup>44</sup> by sampling the deposits and applying the external sample results to

the bulk deposit geometry; and in two cases<sup>45,46</sup> by neutron coincidence counting with polyethylene-moderated <sup>3</sup>He slab detectors. These effects arise from

1. equipment attenuation of gamma-ray intensities,
2. self-attenuation of gamma-ray intensities,
3. finite dimensions of source (inventory/holdup) deposits, and
4. interfering gamma rays from other radionuclides.

Ignoring the effects of 1-3 above causes a negative bias in the assay of

<sup>239</sup>Pu. Ignoring 4 in the same application causes a positive bias in the quantitative assay. Evaluating the correction factors and applying them to obtain a corrected assay result removes most of the bias but creates additional systematic effects that result from uncertainties in the large correction factors. Although the four effects described above are specific to the gamma-ray assays, the gamma-ray methods also offer some advantages over neutron coincidence counting for verification of quantities of in-process plutonium inventory. The advantages of the gamma-ray methods include

Table IX. Characteristics of Equipment and SNM for Holdup Measurements

Process Equipment	Equipment Dimensions* and Geometry	Description of SNM Loading	SNM Reference Value (g <sup>235</sup> U)	Alternative Generalized Geometries
Pipe Array, Steel	diameter = 2.8 cm thickness = 0.3–0.6 cm length = 540 cm 3 parallel, confluent lines 2 right angles, 1 T	2 LEU fuel rods, 3 vials HEU oxide	17.63	point, line, area
V-Blender, Plastic	diameter = 18 cm thickness = 0.7 cm length = 55 cm symmetric V cylinder	2 bottles LEU oxide in graphite matrix	9.76	point, area
Pipe, Aluminum	diameter = 14 cm thickness = 0.3 cm length = 240 cm straight cylinder	9 LEU fuel rods	16.83	line
Pipe, Steel	diameter = 11 cm thickness = 0.3 cm length = 320 cm straight cylinder	6 long sheets of HEU metal	45.44	line
Floor Spot, Plastic	length = 45 cm width = 45 cm thickness = 0.4 cm thin square laminate	1 square sheet of HEU metal	38.47	area, point
Rectangular Duct, Steel	width = 25 cm height = 8 cm thickness = 0.1 cm length = 400 cm 1 right angle bend	14 LEU fuel rods	26.17	line, area

\*The inner dimensions of equipment cavities are quoted.

- defining locations of plutonium deposits using collimation;
- quantifying localized plutonium deposits independent of other nearby (larger or smaller) deposits of plutonium using collimation shielding;
- shielding effectively against room background;
- confirming by spectroscopy the identity of the isotope that produces the assay signal;

- simultaneously performing quantitative assays, by spectroscopy, of multiple isotopes/elements; and
- performing portable quantitative assays of deposits of plutonium in locations that are not accessible to neutron detectors.

During a recent field exercise, both neutron coincidence counting and portable gamma-ray spectroscopy (with

NaI and GGH) were used to independently determine the in-process inventory of HBU plutonium in a glove box that receives, blends, and transfers oxide powder. Because the sensitivities of two techniques are complementary in many ways, agreement between the neutron and gamma-ray assays is a good verification of the in-process inventory of plutonium. In this exercise, agreement to 10% was achieved despite particularly large

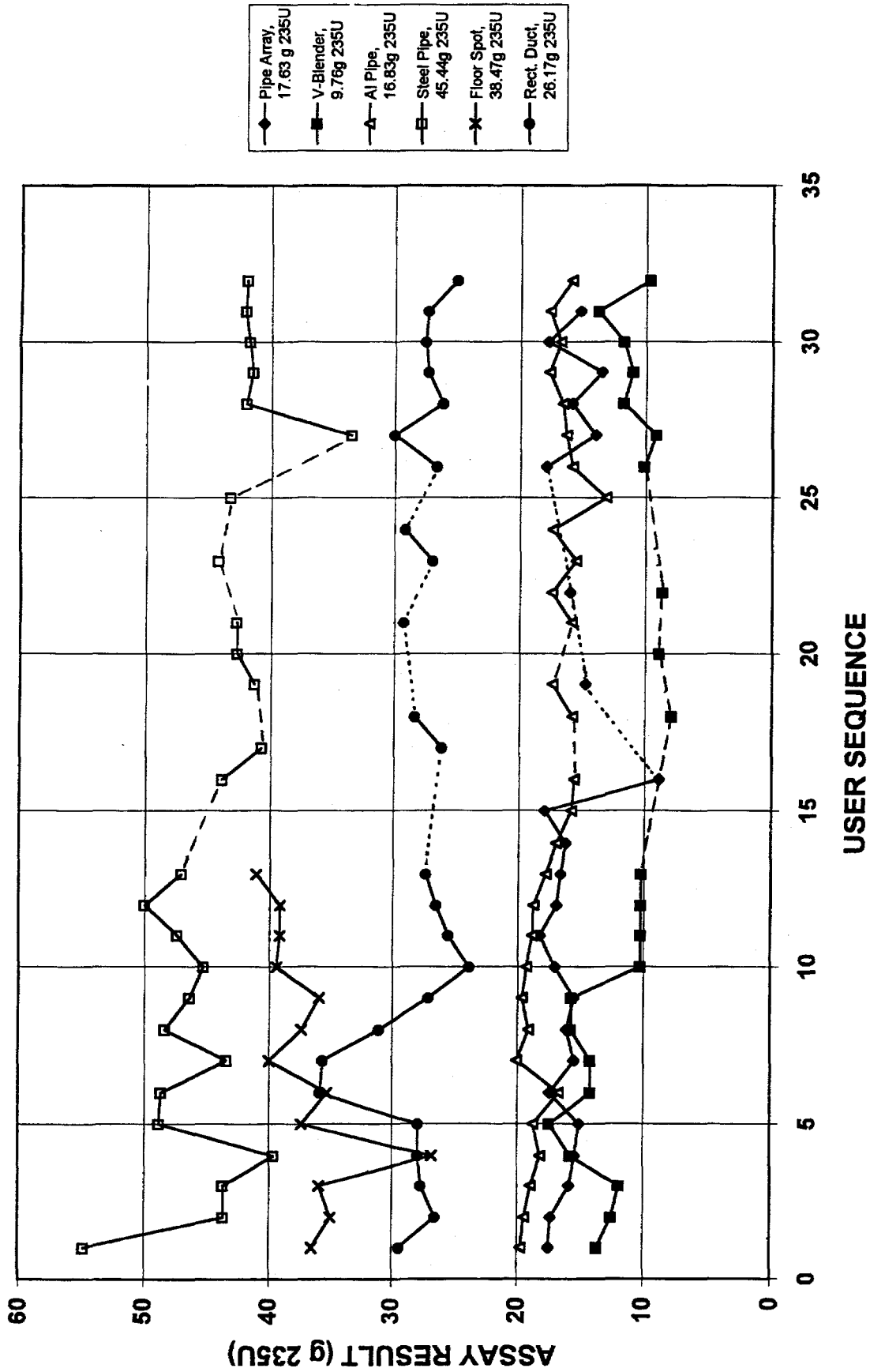

Fig. 21. The GGH assay result is plotted chronologically for <sup>235</sup>U mass obtained with the automated integrated holdup measurement system for each of the six holdup simulations by each measurement team involved in the measurements during the three-year test period.

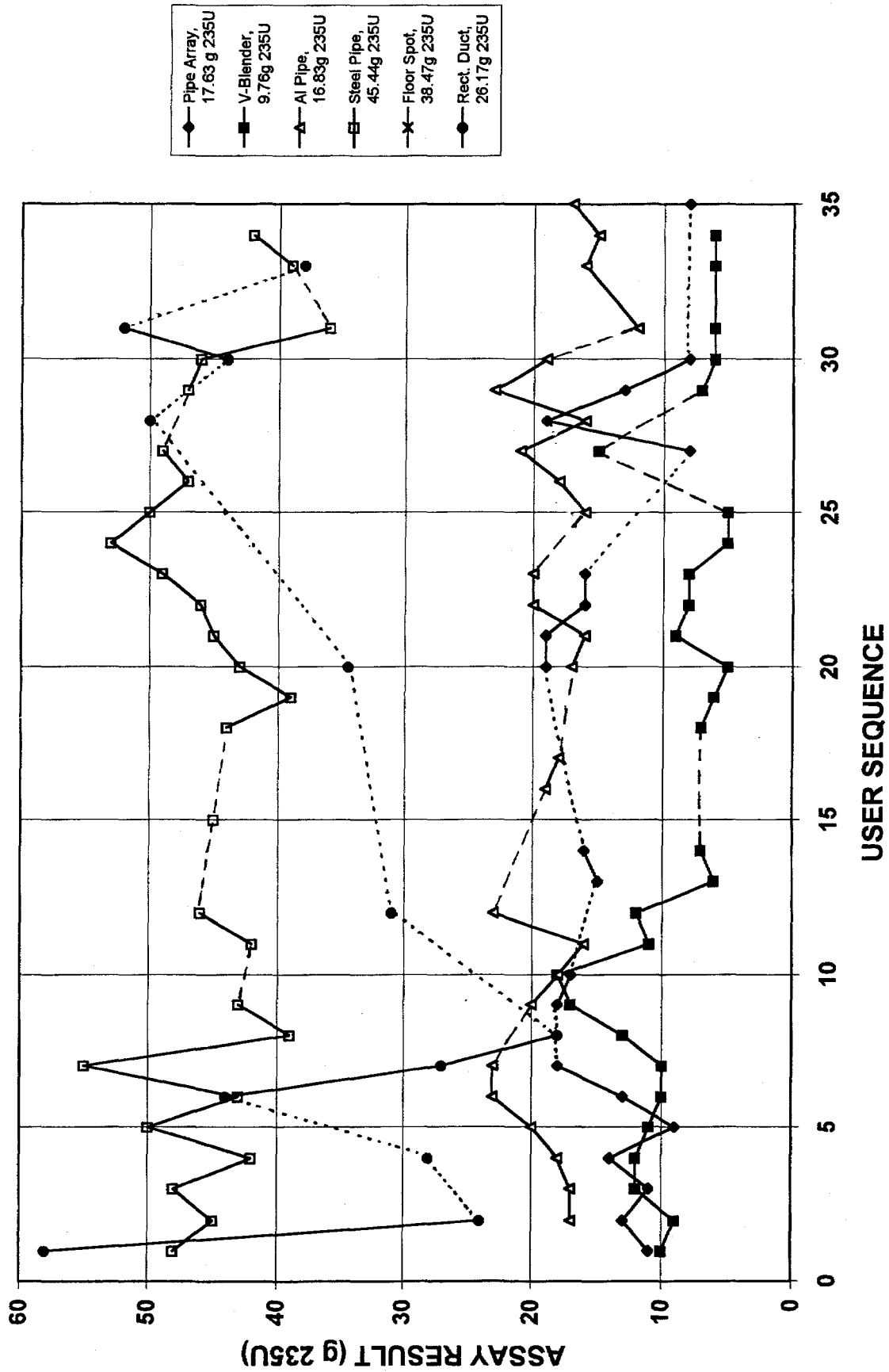

Fig. 22. The GGH assay result is plotted chronologically for <sup>235</sup>U mass obtained by manual holdup measurements for each of the six holdup simulations by each measurement team involved in the measurements during the three-year test period.

Table X. Portable Automated and Manual Holdup Assay Results ( $\text{g } ^{235}\text{U}_{\text{MeasAvg}}/\text{g } ^{235}\text{U}_{\text{ref}}$ )

Process Equipment, Holdup Reference Value	Pipe Array, 17.63 g $^{235}\text{U}$	V-Blender, 9.76 g $^{235}\text{U}$	Al Pipe, 16.83 g $^{235}\text{U}$	Steel Pipe, 45.44 g $^{235}\text{U}$	Floor Spot, 38.47 g $^{235}\text{U}$	Rect. Duct, 26.17 g $^{235}\text{U}$	Average Std. Dev.
$^{235}\text{U}_{\text{Avg}}$ (automated)/ $^{235}\text{U}_{\text{ref}}$	0.90	1.22	1.03	0.97	0.96	1.07	1.03
$^{235}\text{U}_{\text{Is}}$ (automated)/ $^{235}\text{U}_{\text{ref}}$	0.11	0.27	0.10	0.09	0.09	0.11	0.11
$^{235}\text{U}_{\text{Avg}}$ (manual)/ $^{235}\text{U}_{\text{ref}}$	0.80	0.93	1.09	1.00	na	1.43	1.05
$^{235}\text{U}_{\text{Is}}$ (manual)/ $^{235}\text{U}_{\text{ref}}$	0.22	0.37	0.16	0.10	na	0.47	0.26

corrections applied to the gamma-ray signals. Because the gamma-ray assay has unique advantages, it would be of value to reduce the magnitude of some of the corrections and thereby improve the quality of the gamma-ray assay results. The evaluation and magnitudes of these corrections are discussed below in the context of the recent measurements. Using improved room-temperature gamma-ray detectors to replace the compact NaI detectors<sup>48</sup> is discussed as a means of minimizing the magnitude of one of the larger correction factors caused by gamma-ray interference, while enhancing the spectroscopic advantages unique to these gamma-ray assays.

### Equipment-Attenuation Corrections to Gamma-Ray GGH Measurements

The corrections for attenuation of gamma rays from in-process inventory or holdup by the process equipment (tubes and pipes, for example) or the process containment (glove box walls including radiation shielding) are the most straightforward, simple, and documented of the four types of corrections required for the GGH assay. They are straightforward because they apply directly to the measured net (and room-background-subtracted) count rates in the assay peaks before other corrections are applied. Furthermore, for a given gamma-ray energy  $E_\gamma$ , the corrections depend only on the composition ( $Z$ , for which a unique mass-attenuation coefficient  $\mu = \mu E_\gamma$  is identified), the

density  $\rho$ , and thickness  $\chi$  of the attenuating material. The equipment-attenuation correction factor is straightforward to obtain by using the formula

$$CF_{\text{EQUIP}}(Z, E_\gamma) = e^{\mu\rho\chi}. \quad (2)$$

For the measurements of HBU plutonium oxide powder,  $E_\gamma$  is 414 keV. Depending on how the room background measurements are performed, the net room-background count rates may also have to be corrected for the effects of equipment attenuation before they are subtracted from the measured net count rates in the assay spectrum.

Lack of knowledge of the process equipment is the main limitation to applying the corrections for equipment attenuation. The equipment is often not directly visible, particularly when it is within a glove box. The distribution of deposits within and on the outer surfaces of glove-box equipment is also unknown. Even when equipment drawings with dimensions are available, the complexity of the process equipment makes it difficult to judge which dimension to choose for  $\chi$ .

For the recent measurements of HBU plutonium oxide powder, the values of  $CF_{\text{EQUIP}}(Z, 414 \text{ keV})$  varied from a minimum of 1.1 (for measurements of floor deposits through lead-lined glove-box gloves) to a maximum of 6.2 (for measurements of floor deposits through steel plates on the glove box floor). A value of 1.4 for the steel equipment within the glove box was used to correct measurements of

internal and external deposits on surfaces of equipment within the glove box. A value of 1.7 was used to correct measurements of deposits in steel pipes that feed powder into the glove box.

### Self-Attenuation Corrections to Gamma-Ray GGH Measurements

Unlike the corrections for equipment attenuation that are applied before other corrections are made, the corrections for self-attenuation of gamma rays by the deposit material must be applied after all other corrections have been made because the self-attenuation corrections are based on the measured areal density,  $(\rho\chi)_{\text{MEAS}}$ , of the deposit element (in g Pu/cm<sup>2</sup> for the HBU plutonium measurements), which can only be determined by quantifying the holdup assay.

The self-attenuation correction is obtained by a bootstrap procedure once the holdup assay (uncorrected for self-attenuation) for a point, line, or area deposit has been computed. For all three geometries, the assay must first be converted to an areal density. If the deposit geometry is a point, the assay (in g Pu) is divided by the estimated cross-sectional area of the point deposit ( $a$ , in cm<sup>2</sup>) to get the measured areal density,  $(\rho\chi)_{\text{MEAS}}$ . If the deposit geometry is a line, the assay (in g Pu/cm) is divided by the estimated width of the line deposit ( $w$ , in cm) to get the measured areal density,  $(\rho\chi)_{\text{MEAS}}$ . If the deposit geometry is an area, the assay (in g Pu/cm<sup>2</sup>) is the measured areal

density,  $(\rho\chi)_{\text{MEAS}}$ . Then the relationship between the measured and corrected areal densities,  $(\rho\chi)_{\text{MEAS}}$  and  $(\rho\chi)_{\text{CORR}}$ , is consulted to obtain the corrected areal density,  $(\rho\chi)_{\text{CORR}}$ .

Figure 23 is a plot of the relationship between  $(\rho\chi)_{\text{MEAS}}$  and  $(\rho\chi)_{\text{CORR}}$ . This relationship is easily obtained by calculating, for a specified range (0–2.5 g Pu/cm<sup>2</sup>, for the data in Fig. 23) of actual element areal densities  $(\rho\chi)_{\text{CORR}}$ , the corresponding self-attenuated densities,  $(\rho\chi)_{\text{MEAS}}$ , assuming that these are assayed using a gamma-ray of energy  $E_\gamma$ . The correction form that is most frequently applied is that of a uniform-slab source counted in far-field geometry. In this case, the calculated values for the measured areal densities are

$$(\rho\chi)_{\text{MEAS}} = (1 - \exp[-\mu(\rho\chi)_{\text{CORR}}])/\mu, \quad (3)$$

where the mass-attenuation coefficient,  $\mu = \mu E_\gamma$ , is that of the actinide material (plutonium) in the deposit. From the Fig. 23 plot of  $(\rho\chi)_{\text{CORR}}$  versus  $(\rho\chi)_{\text{MEAS}}$  (or from a fit to these data), it is straightforward to obtain the self-attenuation-corrected areal density for a given measured areal density. The corrected assay result is then obtained by the inverse of the process used to obtain the measured areal density.

If the deposit geometry is a point, the corrected areal density,  $(\rho\chi)_{\text{CORR}}$  (in g Pu/cm<sup>2</sup>), is multiplied by the estimated cross-sectional area of the point deposit ( $a$ , in cm<sup>2</sup>) to get the corrected assay (in g Pu). If the deposit geometry is a line, the corrected areal density,  $(\rho\chi)_{\text{CORR}}$  (in g Pu/cm<sup>2</sup>) is multiplied by the estimated width of the line deposit ( $w$ , in cm) to get the corrected assay (in g Pu/cm). If the deposit geometry is an area, the corrected areal density,  $(\rho\chi)_{\text{CORR}}$  (in g Pu/cm<sup>2</sup>) is the corrected assay. Therefore, the correction factor for self-attenuation that is finally applied to the uncorrected assay result is the ratio

$$CF_{\text{SELF}} = (\rho\chi)_{\text{CORR}} / (\rho\chi)_{\text{MEAS}} \quad (4)$$

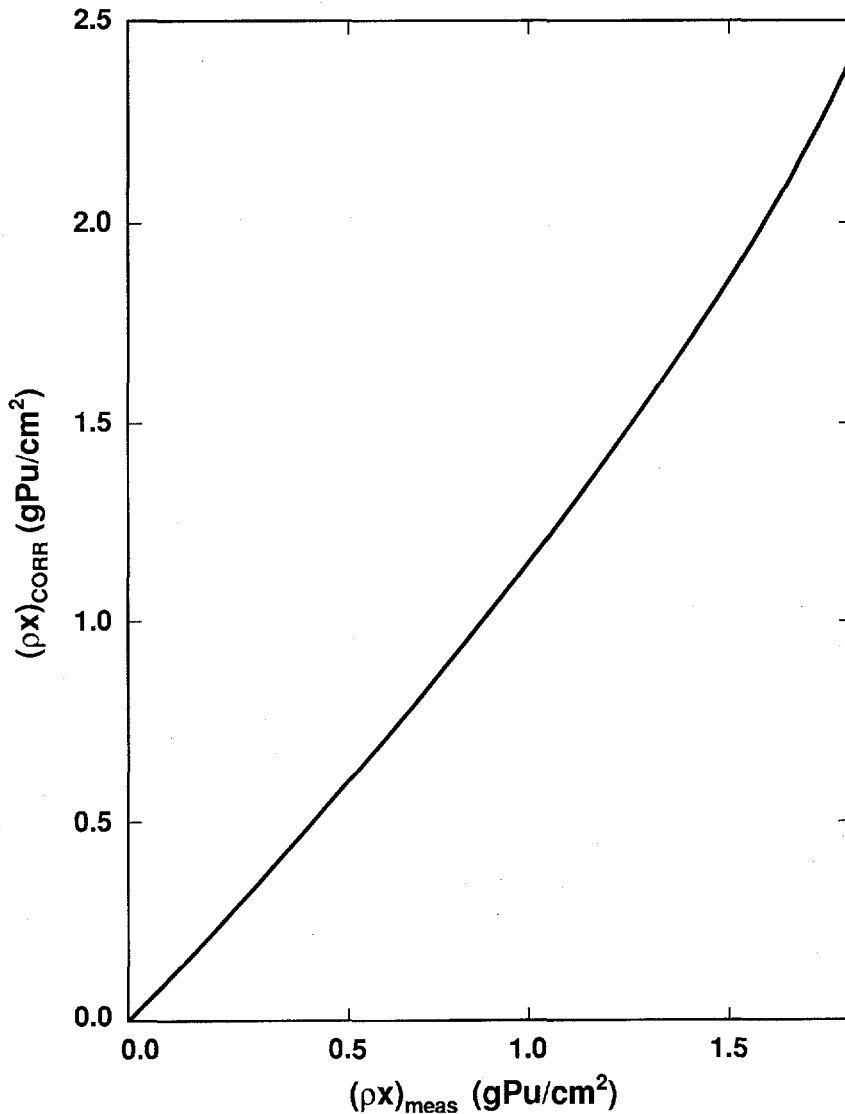

Fig. 23. The self-attenuation-corrected (or true) value of the areal density of a deposit versus the uncorrected value measured by the GGH method. The plotted results were calculated from Eq. (2) in the text.

For the recent measurements of HBU plutonium oxide powder, the value of  $CF_{\text{SELF}}$  using Eq. (4) was as large as 1.11 for oxide deposits on the glove box floor.

#### Finite-Source Corrections to Gamma-Ray GGH Measurements

The corrections for finite source dimensions apply to point or line deposits whose dimension (area or width, respectively) is not small, as defined below, compared to the detector's field of view of the deposit. Such

corrections are often necessary because the detector cannot be positioned far enough from the deposit (because of physical obstacles, inclusion of other sources in the collimated field of view, or losses in the ratio of signal to background) to satisfy the requirement for a "small" point or a "narrow" line. Such corrections do not apply to area deposits, which are distributed over the entire field of view of the detector. The finite-source corrections are most frequently applied to the measured count rates that are corrected for equipment attenuation.

Figure 24 is a plot of the normalized radial response (RR) of the compact NaI detector<sup>48</sup> (with the 2.5-cm-diameter by 5-cm-thick crystal) used for the portable measurements of plutonium. The net count rate, with the continuum-background subtracted, for each of two regions of interest (set on the 208-keV and the 414-keV peaks from the decay of <sup>241</sup>Pu and <sup>239</sup>Pu, respectively) is plotted for a point reference source of plutonium positioned on a line that is 40 cm ( $r_0$ ) from the surface of the detector crystal. The horizontal axis indicates the displacement of the reference source from the axial position (intersecting the crystal's longitudinal axis). The measured rates are normalized to the rate determined in the axial measurement. Thus, the FWHM of RR measured at a distance  $r_0$  is the full width at a normalized response of 0.5. Similarly, the full width at the 0.05-maximum FW of the radial response is the full width at a normalized response of 0.05. It is assumed that the radial-response width varies linearly with  $r$ , the distance from the detector to the deposit and is zero at  $r = 0$  cm. Consequently, the dependence of the FWHM and FW normalized to FWHM<sub>0</sub> and FW<sub>0</sub> (FWHM and FW at  $r=r_0$ , respectively) can be plotted as shown in Fig. 25. This assumption of linearity and the radial response plot in Fig. 24 are both used to determine the corrections for finite-source dimensions.

Upon measurement at distance  $r$  of a finite source with dimension  $d$  (diameter of finite point source or width of finite-width line source), the ratio  $r/r_0$  is used to normalize the finite source dimension to give

$$d_0 = d \cdot (r/r_0)^{-1}. \quad (5)$$

The value of the normalized radial response corresponding to an axial displacement of  $d_0/2$ ,  $RR(d_0/2)$ , is determined from Fig. 24. This result is averaged with 1 to give the effective radial response,

$$RR_{\text{EFF}} = [1 + RR(d_0/2)] / 2, \quad (6)$$

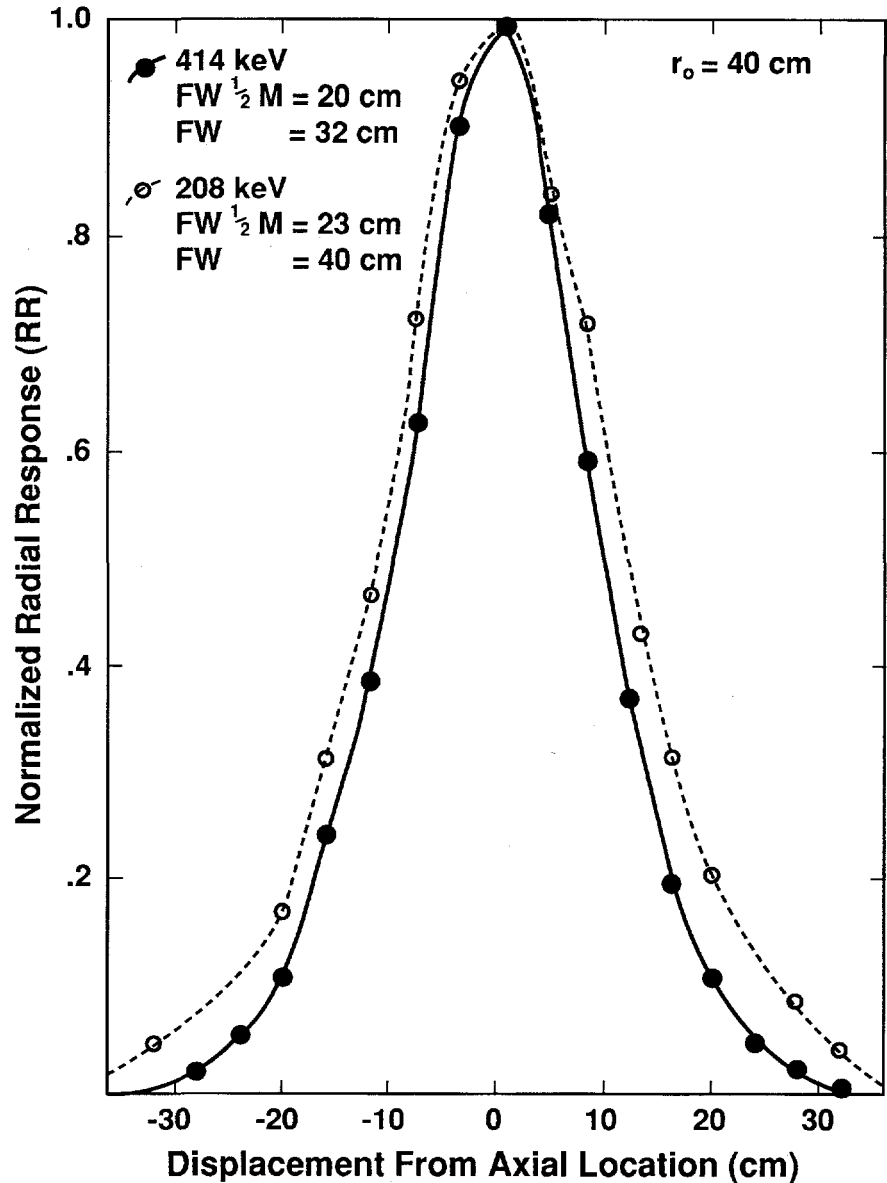

Fig. 24. The normalized radial response of the compact, 5-cm-thick, sodium iodide detector<sup>48</sup> (which uses a 2.5-cm-long by 2.5-cm-diameter cylindrical collimator) is plotted for the 414-keV gamma ray of <sup>239</sup>Pu and the 208-keV gamma ray of <sup>241</sup>Pu-<sup>237</sup>U. The abscissa is the horizontal displacement of the point plutonium source relative to the detector axis on a line at a distance  $r_0$  from the crystal surface, where  $r_0 = 40$  cm. The detector response is normalized to the response at the zero displacement position. Both the FWHM and the FW measured at the distance  $r_0$  are indicated for each radial response.

for the finite source. For a line source assay, the finite-source correction factor is

$$CF_{\text{FIN. LINE SRC.}} = (RR_{\text{EFF}})^{-1}, \quad (7)$$

and for a point source, it is

$$CF_{\text{FIN. POINT SRC.}} = (RR_{\text{EFF}})^{-2}. \quad (8)$$

An example is the measurement of the 414-keV activity from a 24-cm-wide horizontal duct as a line at  $r = 80$  cm. For  $r_0 = 40$  cm, the value of  $d_0/2$  is 6 cm, and the value of  $RR(d_0/2)$  determined from Fig. 24 is



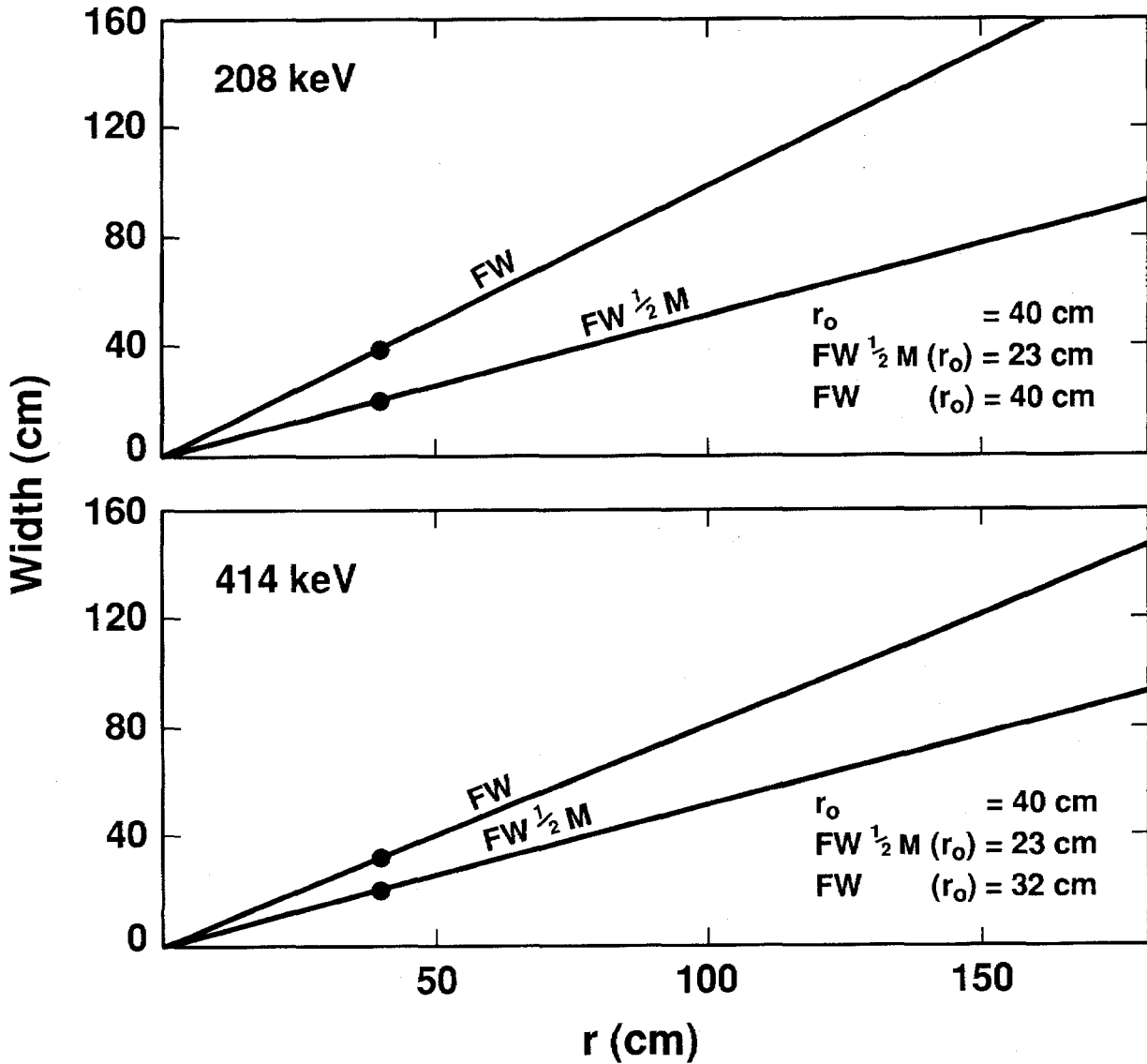

Fig. 25. The normalized (FWHM) and the FW of the radial response of the compact, 5-cm-thick sodium iodide<sup>48</sup> detector plotted versus  $r$ , the distance between the source and the crystal surface for the 208- (upper plot) and the 414-keV (lower plot) gamma rays. The plotted results are normalized to the FWHM and FW values measured at  $r_0 = 40$  cm.

$$RR(6 \text{ cm}) = (0.68 + 0.65)/2 = 0.665, \quad (9)$$

where this average value is determined from both sides of the slightly asymmetric radial response. Therefore, the effective normalized radial response to deposits in the duct is

$$RR_{EFF} = (1 + 0.665)/2 = 0.83 \quad (10)$$

Finally, the correction factor, which multiplies the measured count rate corrected for equipment attenuation for the duct

line-source deposit in this example is

$$CF_{FIN. LINE SRC.} = (0.83)^{-1} = 1.20. \quad (11)$$

For the recent measurements of HBU plutonium oxide powder, the values of  $CF_{FIN. SRC.}$  varied from 1 (for many measurements, which were treated as area deposits) to 1.25 for line-source oxide deposits on the glove box floor that were measured close to the deposit location.

### Interference Corrections to Gamma-Ray GGH Measurements

The origins and magnitudes of the age- and burnup-dependent biases in the quantitative assay of <sup>239</sup>Pu by low-resolution gamma-ray spectroscopy that arise from gamma-ray interference have been discussed in detail.<sup>49</sup> The interferences are mainly gamma rays originating from the decay of <sup>241</sup>Am (that grows into the deposits with time as a result of the alpha-decay of the

$^{241}\text{Pu}$  parent that is particularly abundant in HBU plutonium) and from decays of the equilibrated parent-daughter pair,  $^{241}\text{Pu}$ - $^{237}\text{U}$ . The magnitudes of the correction factors for gamma-ray interference,  $CF_{\gamma\text{INTERF}}$ , applied to the recent measurements of HBU plutonium oxide powder varied from  $1.4^{-1}$  for measurements of the glove box floor to  $1.6^{-1}$  for measurements of powder transfer piping.

A comparison of the compact NaI gamma-ray spectra for these HBU plutonium oxide deposits with those of the HBU plutonium oxide reference materials used to evaluate the interference bias effects has revealed significant differences between low-resolution gamma-ray spectra for the process materials and pure plutonium oxide reference materials. Figure 26 illustrates the differences with two gamma-ray spectra obtained with the same compact NaI detector and electronics, overlaid on the same plot with matched gains (but arbitrary normalization). The low-resolution gamma-ray spectrum of process material shows significant activity in the 300-keV energy region that is absent from the spectrum obtained for Ref. 11 of HBU plutonium oxide.

In fact, all of the more than 100 gamma-ray spectra of the HBU plutonium process material differ from the reference materials in this way. However, examination of the several high-resolution gamma-ray spectra of HBU plutonium process material that were obtained with a portable high-purity germanium (HPGe) detector during the recent exercises has revealed the origin of the differences between the NaI spectra of the process and reference materials. Figure 27 is one of the high-resolution gamma-ray spectra plotted from 280 to 460 keV. This figure labels the prominent gamma rays from  $^{239}\text{Pu}$  as well as those of  $^{241}\text{Pu}$  (actually  $^{241}\text{Pu}$ - $^{237}\text{U}$ ) and  $^{241}\text{Am}$  that also appear in the HPGe gamma-ray spectra of the pure plutonium oxide reference material. The figure also indicates intense gamma rays from

neptunium (actually from the equilibrated  $^{237}\text{Np}$ - $^{233}\text{Pa}$  parent-daughter pair) that do not appear in the HPGe gamma-ray spectra of the pure plutonium oxide reference material. While the most intense neptunium gamma rays occur near 300 keV, below the  $^{239}\text{Pu}$  assay region, they contribute significantly to the energy region that is used to correct the  $^{239}\text{Pu}$  assay signal for gamma-ray interference. Other neptunium gamma rays indicated in Fig. 27 interfere directly in the  $^{239}\text{Pu}$  assay region that is set from 380 to 450 keV, including one at 375.4 keV, one at 398.8 keV, and particularly one at 416 keV, each appearing to be  $\sim 10$ -30% of the intensity of the 414-keV peak of  $^{239}\text{Pu}$  in Fig. 27. These relative intensities vary for different deposit locations.

Because of its large size and correspondingly larger weight when shielded and collimated, the HPGe detector does not offer a solution to these complex gamma-ray interference problems. However, a room-temperature gamma-ray detector with intermediate resolution and improved performance, such as the coplanar-grid CdZnTe detector (described previously<sup>49</sup>), will greatly reduce the magnitude of the interference corrections for  $^{241}\text{Pu}$  and  $^{241}\text{Am}$ . This detector will also allow independent analysis of the 300- and 312-keV  $^{237}\text{Np}$ - $^{233}\text{Pa}$  gamma rays so that we can correct for the neptunium interference in the 414-keV assay of  $^{239}\text{Pu}$ . The new room-temperature detectors in these applications will be evaluated in 1996.

### Comparison Between Gamma-Ray GGH Measurements and Neutron Coincidence Assays

The GGH technology with portable spectroscopy equipment and compact NaI detectors was used recently for measurements of in-process HBU plutonium inventory in a glove box that receives, blends, and transfers oxide powder. Twenty eight 100-s spectra were acquired in side views at the glove-box ports, views from below of

the glove-box floor, and views of the powder transfer piping that feeds the glove box. Both line- and area-source models were used to interpret the measurement data. Neutron coincidence counting was also used in an independent measurement of the in-process HBU plutonium inventory in the glove box. The ratio of the gamma-ray-GGH to neutron-coincidence assays of plutonium in the glove box was 0.93. This reasonably good agreement was obtained despite large corrections to the gamma-ray measurements for the effects of equipment attenuation ( $CF_{\text{EQUIP}} = 1.1$  to  $6.2$ ), self-attenuation ( $CF_{\text{SELF}} = 1.0$  to  $1.1$ ), finite source dimensions ( $CF_{\text{FIN.SRC}} = 1.0$  to  $1.3$ ), and gamma-ray interference ( $CF_{\gamma\text{INTERF}} = 1.4^{-1}$  to  $1.6^{-1}$ ). The most uncertain correction factor is that for the gamma-ray interference. Improvements in room-temperature gamma-ray detectors anticipated from the coplanar-grid technology will significantly reduce the magnitude of the correction for gamma-ray interference (such that  $CF_{\gamma\text{INTERF}}$  will approach 1), permit additional interference effects such as those from neptunium to be evaluated, and expand the range of individual isotopes that can be assayed simultaneously by portable gamma-ray spectroscopy using the GGH method and room-temperature gamma-ray detectors.

**Assessment of NDA Requirements for Measurements of Rocky Flats Residues (P. A. Russo, M. M. Pickrell, N. Ensslin, NIS-5; K. L. Coop, R. Estep, N. J. Nicholas, NIS-6; and M. C. Lucas, NIS-SG).** Accountable plutonium holdings at RFETS designated as residues are scheduled for stabilization during the next five years. The treatment of these residues, whose current dispositions are undefined because of chemical or physical instabilities or inadequate packaging, will enable shipment, long-term storage, or disposal (as waste) of these materials. We have evaluated and recommended NDA methods to support the safeguarding of the accountable residues before,

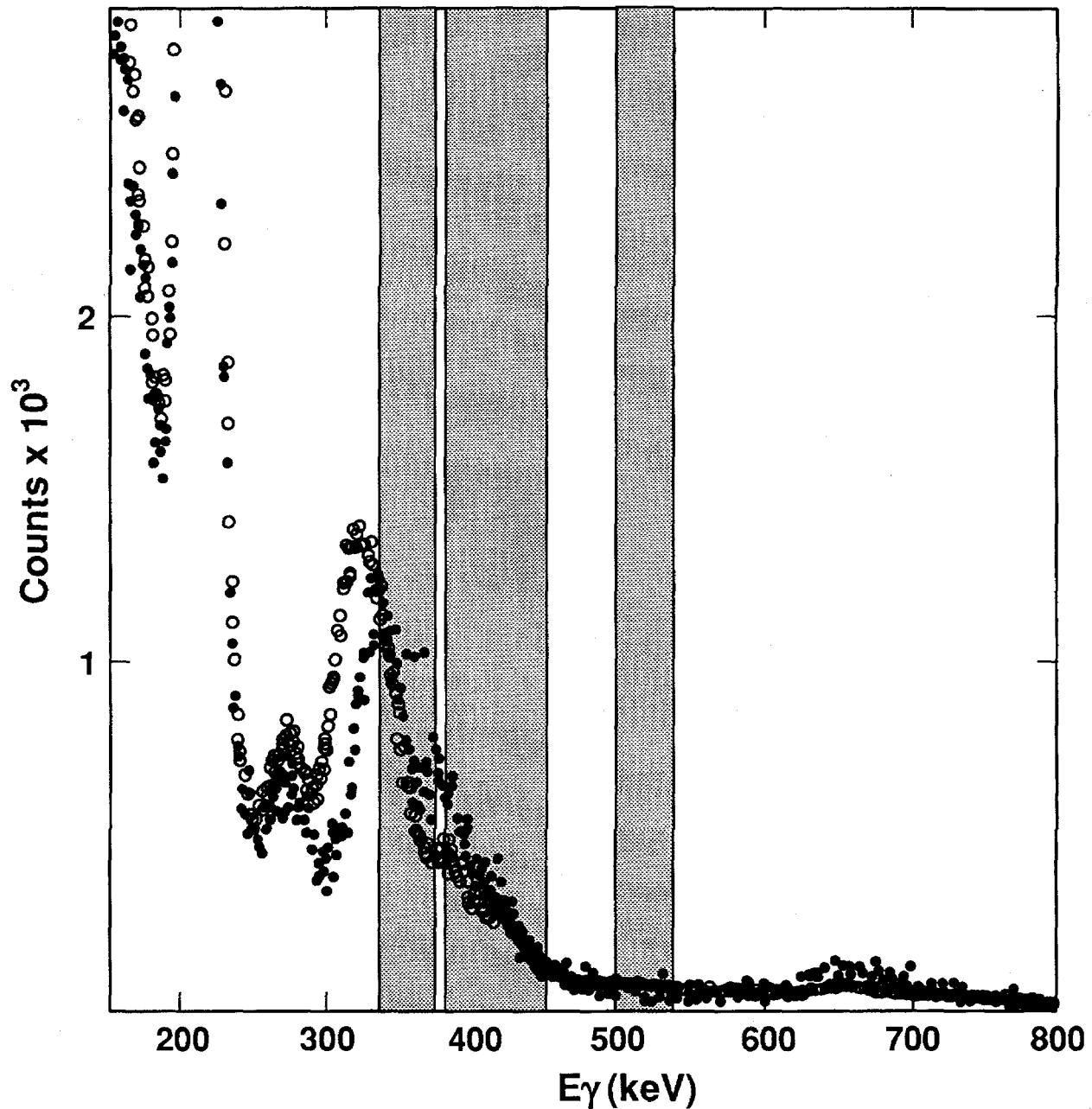

Fig. 26. An example of one of many sodium-iodide gamma-ray spectra of HBU plutonium process material (open circles) is overlaid on the same plot (with matched gains but arbitrary normalization) of the spectrum obtained for Ref. 11 of HBU plutonium oxide (solid circles). The plot shows the energy region from 200 to 800 keV. Both gamma-ray spectra were obtained with the same compact sodium iodide detector and electronics. The low-resolution gamma-ray spectra of the process material all show significant activity in the 300-keV energy region that is absent from the spectra of the pure HBU plutonium oxide reference samples as well as common differences in other regions of the spectrum. These differences suggest the presence of gamma-ray-emitting radioisotopes other than the plutonium isotopes and  $^{241}\text{Am}$  in the process materials.

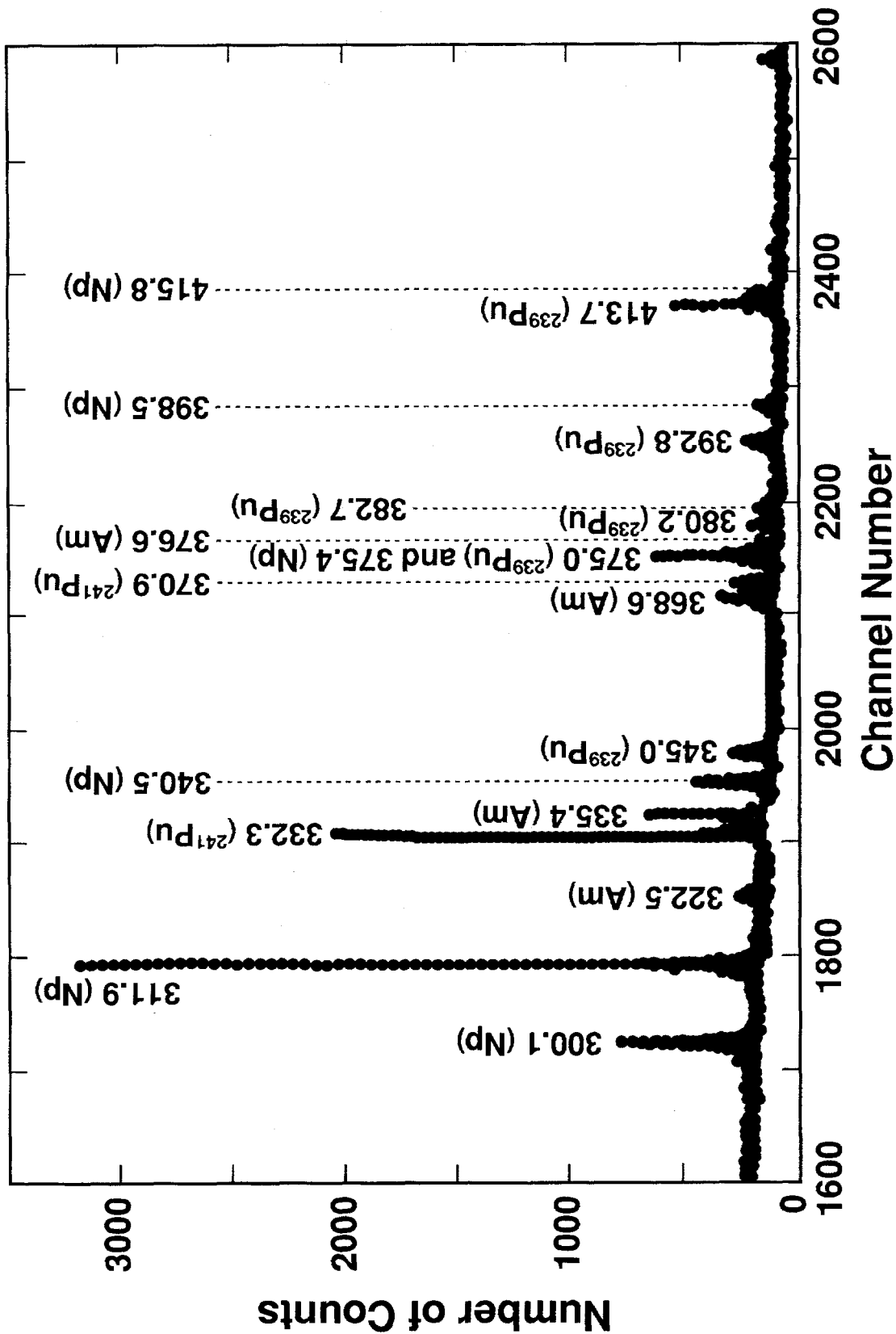

Fig. 27. An example of a high-resolution gamma-ray spectrum of the HBU plutonium process material is shown for the energy region from 275 to 450 keV. In addition to gamma rays resulting from the decay of <sup>239</sup>Pu, <sup>241</sup>Pu, and <sup>241</sup>Am, these spectra include intense peaks that result from the decay of <sup>237</sup>Np in equilibrium with its <sup>233</sup>Pa daughter by alpha decay. The labeled (Np) peaks do not appear in the high-resolution gamma-ray spectra of the HBU plutonium oxide reference materials and are the source of the differences between the low-resolution gamma-ray spectra of the process and reference materials, such as those in Fig. 26.

throughout, and beyond the stabilization treatment processes. The approach to this study was to group the majority of the plutonium residues, representing 100 distinct plutonium item description codes (IDCs), into 13 generic groups such that recommended NDA methods would be common to all materials within a group. The fraction of the facility-wide accountable material holdings represented by the 13 residue groups was evaluated to determine the additional benefit of NDA designed for plutonium residues to the overall MC&A needs at RFETS. The applicability (to each of the 13 residue groups) of each recommended NDA instrument was addressed. However, the study also pointed out the flexibility of NDA designed for residues particularly in application to other materials, including those rich in plutonium as well as plutonium waste materials.

**Grouping the Residues**

Accountable materials at RFETS, including residues, are either discrete items (whose accountability values represent the entire contents of the outermost sealed containers) or components (individually accountable items within an outer container that is also sealed and documented in the accountability system). Residues are also listed by outer-package type (can or drum, where some drums are component drums). Finally, materials designated as residues are distinguished by IDC, where 100 IDCs labeled as residues are

approximately one third of the IDCs at RFETS. The study has summarized the basis for grouping residues by IDC to specify applicable NDA methods. The tabulated results of the study refer to the following abbreviated titles of the 13 IDC residue groupings.

- O Impure Oxide
- F Impure Fluoride
- Gc Coarse Graphite
- Gf Graphite Fines
- Cw Wet Combustibles
- Cd Dry Combustibles
- CC Ceramic Crucibles
- SS Sand, Slag, and Crucible
- MS Am. Extraction Spent Salt
- ER Electrorefining Spent Salt
- A Ash
- GL Glass (Boron-Free)
- M Light Metal

**Benefits of NDA for Residues**

The results of the analysis of the benefits of NDA, designed for and applied only to residues, are summarized in Table XI. The benefits to the residue stabilization effort are high (as indicated in columns 1-3) in that the residues included in the 13 IDC groupings addressed by the recommended NDA methods represent 95% of the total number of residue containers. Furthermore, because most residue drums are component drums, the (more than 7500) designated residue items represent more than 25 000 individually accountable items at RFETS. The benefits to safeguarding accountable nuclear material are great as well. However, as

given in Table XI, these are the minimum benefits provided to safeguards because they are tabulated only for the residue portion of the accountable holdings. Despite the limited tabulation, the 95% benefit to residues also represents a nearly 50% benefit to all accountable plutonium items on site in terms of the number of items and nearly 25% in terms of the total accountable mass. These tabulated benefits increase substantially when additional accountable, nonresidue holdings are added, to which the recommended NDA methods apply.

**NDA Recommendations**

The study reviews current NDA methods that might be considered for plutonium residues, including those available commercially, those in place at RFETS, and those whose prototypes have been recently tested but have not yet been manufactured commercially. The application of the basic physics principles to each quantitative NDA method is discussed; capabilities and limitations are presented in this context. Thirteen distinct types of NDA instruments are reviewed. Of these, six have been recommended for assay of plutonium residues. The availability and general applicability of these six are summarized in Table XII. Table XII also names and qualifies the residue categories (of the 13 residue groupings listed above) recommended for assay by each of the six NDA instruments and indicates and qualifies those that

Number [%] of Designated Residue Items*			Percentage of Accountable Items On Site*			Percentage of Accountable Mass on Site*		
Residue Container Type			Type of Accountable Item			Type of Accountable Item		
Drums	Cans	Both	Component	Discrete	Both	Component	Discrete	Both
3660 [93.1%]	3882 [96.6%]	7542 [94.9%]	73.1%	30.3%	46.4%	28.7%	20.1%	23.1%

\*Represented by the 13 residue groupings.

Table XII. NDA Instruments/Methods Recommended (or Not Recommended) for Residues

NDA Instrument or Method			Quantitative NDA Should Apply To...	Quantitative NDA Should Not Apply To...
Availability	Applicability	Delivery	(IDC Group, Pu Mass, Pu Density)	(IDC Group, Pu Mass, Pu Density)
<b>CALISO: Calorimetry Plus Gamma-Ray Isotopics</b>				
commercial (CAL: EG&G-Mound and ISO: Canberra, Ortec) hardware**; current (RFETS, LANL) ISO-s'ware**	o cans o stationary o at-/on-line o assays: Pu isotopics Pu mass	12-24 months (primarily for CAL)	o residues in cans o higher (>30 g) Pu content o Pu compounds (O, F) o cans of most salts, crucibles, graphite, ash (SS, ER, CC, G <sub>C</sub> , G <sub>F</sub> , A), most cans of MS salts o highest-Am-concentration MS salts	o residues in drums o lower (<30 g) Pu-content residues o combustibles, glass, and metal (C <sub>w</sub> , C <sub>d</sub> , GL, M), and some salts (SS, MS, ER) in cans, primarily due to low Pu content
<b>LCSGS(ISO): Lump-Corrected SGS (With Isotopics)</b>				
commercial (Canberra, Ortec) hardware**; current (LANL) software	o cans o stat./mobile o at-/on-line o assays: Pu isotopics U, Pu mass	6-12 months for new in- strument or software upgrade to LC(ISO)	o residues in (<5 gal.) cans/bottles o low-areal-density (<10-g/cm <sup>2</sup> )* residues only, such as combustibles (C <sub>w</sub> and C <sub>d</sub> ); the inability of LCSGS to distinguish between (SNM) lumps and matrix inhomogeneity causes Bias that increases with Areal Density (BAD).	o residues in drums, regardless of IDC, due to matrix/packing inhomogeneity o medium/high-areal-density (>10-g/cm <sup>2</sup> )* residues, due to matrix/packing inhomogeneity o salts, crucibles, graphite, ash, metal, glass (SS, MS, ER, CC, G <sub>C</sub> , G <sub>F</sub> , A, M, GL) and Pu compounds (O, F) due to BAD
<b>TGS: Tomographic Gamma-Ray Scanner With Isotopics</b>				
new-design (LANL) hardware and software; may be fabricated for specific applica- tions (LANL)	o cans, drums o stat./mobile o at-line o assays: Pu isotopics U, Pu mass	12 months minimum for new instru- ment w/ISO; 6-12 months w/o ISO	o residues in cans/bottles or drums o low/medium-areal-density (<100-g/cm <sup>2</sup> )* residues, due to 2-D (vs. 1-D) scan o combustibles and glass (C <sub>w</sub> , C <sub>d</sub> , GL), most salts, crucibles, and graphite (SS, MS, ER, CC, G <sub>C</sub> , G <sub>F</sub> ), most ash and metal (A, M)	o higher-areal-density (>100-g/cm <sup>2</sup> )* residues o Pu compounds (O, F), certain cans of salts and graphite (ER, G <sub>F</sub> ), certain cans of ash (A), due to high areal density
<b>AAS: Add-A-Source Neutron Drum Counter</b>				
commercial (Can- berra) hardware and software; may be fabricated for specific applica- tions (LANL)	o drums o stat./mobile o at-line o assays: <sup>240</sup> Pu <sub>EFF</sub>	o residues in drums**** 6 months minimum	o drums that contain a minimum of 1 g of Pu*** o drums of combustibles and glass (C <sub>w</sub> , C <sub>d</sub> , GL), salts, crucibles, graphite, ash and metal (SS, MS, ER, CC, G <sub>C</sub> , G <sub>F</sub> , A, M), non-F compounds (O)	o residues in cans**** o drums that contain less than 1 g of Pu*** o >10%-Am-concentration MS salts, due to high α,n neutron rates o Pu fluoride compounds (F), due to high α,n neutron rates
<b>NMC: Neutron Multiplicity Counter for Cans to 30-Gal. Drums</b>				
new-design (LANL) hardware** and software**; may be fabricated for specific applica- tions (LANL)	o cans, drums o stat./mobile o at-line o assays: <sup>240</sup> Pu <sub>EFF</sub> , <sup>235</sup> U, <sup>239</sup> Pu (active)	6 months minimum for new instru- ment	o residues in cans up to 30-gal. drums o cans/drums that contain a minimum of 1 g of Pu*** o up to 30-gal. containers of combustibles and glass (C <sub>w</sub> , C <sub>d</sub> , GL), salts, crucibles, graphite, ash, metal (SS, MS, ER, CC, G <sub>C</sub> , G <sub>F</sub> , A, M), non-F compounds (O)	o residues in >30-gal. drums o cans/drums that contain less than 1 g of Pu*** o >10%-Am-concentration MS salts, due to high α,n neutron rates o Pu fluoride compounds (F), due to high α,n neutron rates
<b>AASNMC: Add-A-Source Neutron Multiplicity Drum Counter</b>				
new design under CRADA (LANL/ Canberra) in progress	o drums o stat./mobile o at-line o assays: <sup>240</sup> Pu <sub>EFF</sub>	12 months minimum	o residues in drums**** o drums containing a minimum of 1 g of Pu*** o drums of combustibles and glass (C <sub>w</sub> , C <sub>d</sub> , GL), salts, crucibles, graphite, ash and metal (SS, MS, ER, CC, G <sub>C</sub> , G <sub>F</sub> , A, M), non-F compounds (O)	o residues in cans**** o drums that contain less than 1 g of Pu*** o >10%-Am-concentration MS salts, due to high α,n neutron rates o Pu fluoride compounds (F), due to high α,n neutron rates

\*For containers of width or diameter d (cm), divide areal density (g/cm<sup>2</sup>) by d to determine density (g/cm<sup>3</sup>).

\*\*Currently available at RFETS.

\*\*\*For low-burnup isotopics, where the <sup>240</sup>Pu fraction is typically 0.06.

\*\*\*\*Because the present instrument is not designed for cans.

are not recommended for assay by each instrument.

The study proposes that a follow-on investigation include extension of the review to address a significant portion of the remainder of the accountable holdings at RFETS. The approach that might be considered is to focus on the six NDA instruments that are recommended to determine their additional impact on the RFETS measurement needs when this complement of accountable holdings is considered.<sup>50</sup>

**Add-A-Source Waste Drum Assay System (H. O. Menlove, D. H. Beddingfield, and M. Pickrell, NIS-5).** The objectives of this project are to design and commercialize a passive neutron assay system with improved performance characteristics for the measurement of plutonium in large scrap and waste containers. The system will address the potential loss or diversion of larger quantities of shielded nuclear material by using segmented add-a-source technology combined with multiplicity neutron counting. The project will be conducted as a CRADA with private industry.

The add-a-source technique uses a small <sup>252</sup>Cf neutron source placed on the outside of the bulk sample container to determine the effect of the sample matrix on the passive neutron assay. The perturbation by the matrix of the coincidence counting rate from the <sup>252</sup>Cf source is used to predict the matrix correction factor for the sample.

We have upgraded the add-a-source technique by incorporating multiple positions for the Cf-252 neutron source on the exterior of a 200-L drum. The multiple positions give better coverage of the drum and have the effect of segmenting the matrix correction as a function of fill height. If there is a localized neutron shield in the drum, the segmented readout of the matrix corrections could flag the anomalous matrix condition.

To test the effectiveness of the segmented add-a-source method, we loaded 200-L drums with heterogeneous mixtures

of concrete, wood, and polyethylene. In some cases, the heavy moderator (such as concrete) was placed in the bottom of the drum, and in one case, the concrete was placed in the top of the drum. Before the add-a-source corrections, the measured results varied by 12%; however, after the correction the error was reduced to only 1%. The test drums with segmented matrix loadings were assayed with an average matrix error of ~1.7%.

The add-a-source method measures the assay perturbation from the matrix material, but it does not determine how the plutonium is distributed in the matrix. The method assumes the plutonium is distributed throughout the drum. Thus, if most of the plutonium were located in a local shield inside the drum, the add-a-source correction would be too small, even though it would flag the anomalous condition.

To improve the measurement accuracy for the case of localized shielding, we are incorporating multiplicity counting into future add-a-source systems. By measuring the singles, doubles, and triples, we can detect large changes in detector efficiency caused by the localized shielding. Calculations using the MCNP code are in progress to design a 200-L-drum detector with higher efficiency to make the multiplicity counting more practical.

The CRADA between Canberra Industries and Los Alamos has been completed and under this cooperative agreement, the partners plan to produce a passive-neutron barrel counter that will permit accurate assay of plutonium in transuranic waste without breaching the waste containers. The technical basis of the CRADA is to develop a state-of-the-art assay system for plutonium in 208-L drums. The advanced system includes the add-a-source feature, multiplicity counting, statistical noise rejection, cosmic-ray background reduction, and high-efficiency design. The instrument will make it easier to detect possible shielding material inside the drum that might be used to conceal the presence of nuclear materials.

For the drum counter to be developed under the new CRADA, the design goals that require optimization are listed in Table XIII. The relative weighting and prioritization of these goals will be determined by Canberra based on market considerations. The parameters that can be used to meet these goals include sample cavity size, active detector volume, detector efficiency, die-away time, shielding (both internal and external), moderator materials, electronic background rejection, smart software, and add-a-source.

The cavity size for the system was set to be the same as the Canberra Model WM3100 drum counter to take advantage of the existing mechanical system. Smaller cavity dimensions would give higher efficiencies and less expensive fabrication costs. However, the requirement to accommodate samples somewhat larger than 200-L drums dictated the WM3100 cavity size.

The design goals, such as precision, that are based on counting statistics can be met by higher efficiency and a lower die-away time as well as by smart software that terminates a measurement based on the statistical error rather than a preset run time. In general, multiplicity counting will require higher efficiency than simple doubles counting, and calculations have been performed to provide the statistical error in multiplicity counting.

The competitive cost criteria will drive many of the design parameters and this will have to come from Canberra's market knowledge. The modular design (e.g., number of helium tubes, detector banks, and shielding) is the key in meeting the competitive pricing factors. The WM3100 provides a good design platform to allow the modular approach.

### Detectability Limit

The optimization of the detectability limit was one of our primary design goals. To obtain a low detectability limit, we need a high counting efficiency

**Table XIII. Design Goals for the Waste Drum Counter**

1. Low detectability limit  
(good sensitivity at low mass)
2. Ability to meet Performance Demonstration Program requirements
  - a. High ( $\alpha, n$ ) backgrounds
  - b. Variable plutonium distribution
  - c. Accuracy
3. Matrix independence
  - a. Plutonium distribution independence
  - b. Accuracy
4. Assay of SNM mixtures
  - a. Plutonium-Uranium
  - b. Pu-<sup>244</sup>Cm
  - c. Accuracy for mixtures
5. Modular detector design
  - a. high/low efficiency
  - b. high/low shielding
  - c. with/without add-a-source
  - d. with/without multiplicity
  - e. flexible software
6. Competitive cost/flexibility

as well as a small active detector volume, a large coincidence gate fraction, and a small neutron-background rate from the room.

Two of these design parameters work in opposition to each other. See Table XIV for a list of the design parameters. That is, the higher-efficiency designs require a larger active volume for the detector. The problem with the large active volume for the detector is that the cosmic-ray spallation background increases linearly with the detector volume and density. Also, the large detector volume displaces the external neutron shielding, increasing the measured background from the room source neutrons (e.g., drums stored near the detector).

The detectability limit can be obtained from totals counting or coincidence counting. In general, the totals-based limit is lower than the coincidence-based limit because of the high totals counting

efficiency. However, variable room background rates and unknown sample ( $\alpha, n$ ) rates make the totals results difficult to interpret, so we will use the coincidence rate for our detectability limit calculation. The limit based on totals neutrons is still a useful screening tool to pass uncontaminated samples.

The detectability limit  $d$  (in grams of <sup>240</sup>Pu) at 3 standard deviations above background can be calculated for the counter using the equation

$$d = (3/a) \cdot \left( \frac{B+ad}{t} \right)^{1/2}, \quad (12)$$

where

$a$  = response of counter in counts/  
(s · g <sup>240</sup>Pu)

$B$  = room background rate, and

$t$  = counting time.

Equation (12) is an approximation based on a long counting time for the

**Table XIV. Design Parameters for the Waste Drum Assay System**

1. Cavity size
2. Active detector volume
3. Detector efficiency
4. Detector die-away time
5. Internal shielding
6. External shielding
7. Moderator materials
8. Statistical background rejection
9. Smart software
10. Spatial imaging
11. Multiplicity counting
12. Add-a-source

cosmic-ray background and a negligible accidental background from the room totals rate. The detectability limit is a function of the neutron coincidence background, and we can reduce our background by a factor of ~2 by eliminating the cosmic-ray spallation event with high multiplicity by using a statistical filtering technique.

Both the calibration constant  $a$  and the background  $B$  are coincidence rates that depend on the efficiency squared. Thus, from Eq. (12) we get

$$d \sim \frac{\sqrt{\epsilon^2}}{\epsilon^2} = \frac{1}{\epsilon}. \quad (13)$$

However, the background term is more complex and it contains two primary components—the cosmic-ray spallation rate and the accidental coincidence rate from the room source totals rate.

The cosmic-ray spallation neutrons increase linearly with the active volume and density of the moderator for the <sup>3</sup>He tube area. Thus, if we double our detector volume or density, we will double our cosmic-ray spallation background.

As a first step in the design optimization, we removed all of the cadmium and heavy metal in the detector to reduce the cosmic-ray spallation rate. The room source neutrons are relatively



easy to remove with external shielding; however, the cosmic-ray background is several orders of magnitude harder to reduce.

### Figure of Merit

To aid in the design optimization based on the detectability limit, we defined a figure-of-merit (FOM) as follows,

$$FOM \sim \frac{1}{d} \sim \epsilon^2 \left[ \frac{f_g}{\epsilon^2 \cdot t \cdot p} \right]^{1/2} \quad (14)$$

$$FOM = \epsilon \left( \frac{f_g}{t \cdot p} \right)^{1/2}, \quad (15)$$

where

- $\epsilon$  = totals counting efficiency (%)
- $r$  = moderator density
- $t$  = moderator thickness (cm)
- $f_g$  = the fraction in the gate for a 128- $\mu$ s gate length.

The value of  $\epsilon$  was determined from the unnormalized results of MCNP calculations. The moderator thickness was determined to be the distance from the inner face of the detector cavity to 1.0 diffusion lengths (2.73 cm in poly and longer for low-hydrogen plastics) beyond the edge of the tube row.

The largest values for the FOM give the smallest detectability limit. Thus, the counting efficiency is only one of the parameters that go into the optimization of the detectability limit. A detector design with two rows of  $^3\text{He}$  tubes or 5-cm-diam tubes is inherently less desirable for the detectability limit (or FOM) optimization because of the added detector thickness caused by the second row of tubes. In effect, the second row of tubes can increase  $\epsilon$  by a factor of  $\sim 1.5$  but it also increases  $t$  by  $\sim 1.7$  so the FOM improves only by  $1.5/\sqrt{1.7}$  or  $\sim 1.15$  and we doubled the number of tubes. The optimized design will have a high number of  $^3\text{He}$  tubes located near the sample cavity to obtain a high efficiency and a small detector volume.

### Summary

We have assumed that the dominant consideration in the design optimization was the detectability limit. A high efficiency is also needed for multiplicity counting but the multiplicity capability will primarily be used in a secondary role and the actual performance criteria will revert to the detectability limit. The key design parameter is the FOM and the resulting cost. However, the cost is a more complex issue involving the  $^3\text{He}$  tubes, moderator, fabrication, and shielding costs. A convenient modular design is required to make the cost flexible to meet variable competitive conditions.

The software to support the segmented add-a-source system has been completed. The software has been upgraded to a Windows version to make it more user friendly. Future software work is planned to merge the add-a-source code with the multiplicity code. This will also be in the Windows format.

The fabrication of the optimized add-a-source system is under way at Canberra Industries, Inc., with completion scheduled for the first half of 1996. After completing the fabrication, the unit will be shipped to Los Alamos for test and evaluation.

**WIN\_TGS Software for Tomographic Assay Systems (R. Estep, J. Cavender, and R. Kandarian, NIS-6).** In 1995 we completed the development and beta-testing of version 2.1 of the WIN\_TGS software, a user-friendly Windows 3.1 program used for data acquisition and scanner control in TGS and SGS systems. In spite of the simple user interface (shown in Fig. 28), WIN\_TGS is flexible and full-featured, with system configuration and control options available using 34 separate dialog boxes accessed through the 38 supervisor's menu options.

The WIN\_TGS software performs low- to medium-resolution tomographic gamma scans, segmented gamma scans, and arbitrary user-defined scans on

radioactive samples of various sizes and shapes. Although it will work using any type of detector that can produce pulse height spectra in the supported multichannel analyzers (MCAs), WIN\_TGS was designed for systems using one or more high-purity germanium (HPGe) detectors to count discrete, full-energy gamma-ray peaks. A full-featured ROI editor allows ROIs to be set on an arbitrary number of gamma-ray peaks in the spectrum, with up to three ROIs per peak (two background and one peak ROI). As many MCAs can be added to the system as desired within hardware limitations, allowing multiple detector scanning.

A key technical feat of WIN\_TGS is its ability to perform continuous motion scans, in which data are collected in tight synchronization with the simultaneously translating and rotating scanner. This scanning mode improves accuracy and throughput over the much slower standard method of moving to a position, counting, moving to the next position, and so on. To achieve our synchronization accuracy of  $\pm 3$  ms per data grab, required developing our own interrupt-driven timer and MCA interface libraries, a particularly difficult task in the Microsoft Windows environment. The result is that over 98% of the approximately 1-h TGS scan time is used in counting the sample, with virtually no wasted motion.

The issue of customization is central to the architecture of WIN\_TGS and related software for T/SGS systems because various DOE sites have different hardware and NDA requirements. Customization at the code level hampers the evolution of software by making the upgrade process clumsy and expensive. In the long-term, the best approach to version control is to reduce the need for code-level customizations. This is what we have attempted to do with our T/SGS software. Our basic approach has been to modularize the overall code into small, stand-alone executable programs—each performing some well-defined task—that use Window's messaging and multitasking capabilities

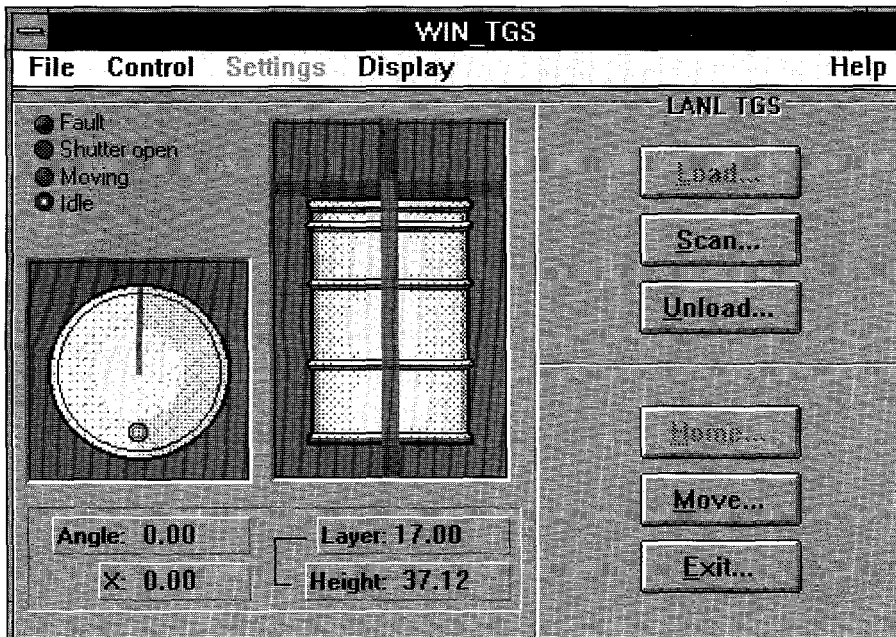

Fig. 28. The WIN\_TGS main window.

to execute simultaneously in a cooperative way. Both hardware and software can be customized using a mix-and-match approach that allows a standard offering of Los Alamos-originated components to be used in combination with site-developed or commercial components.

To provide mix-and-match software capability, WIN\_TGS communicates with other software by acting as a black box server. As a black box server, WIN\_TGS sends simple status messages over the Windows message queue to all applications "registered" in its list of black box clients. Applications that perform image reconstruction, mass calculation, image display, databasing, and other specialized tasks can use the black box protocol to create a processing chain that passes control from one program to the next, in parallel or in series, forming an analysis sequence that can be tailored to site needs. This allows the suite of programs to appear to the operator as a single monolithic program while allowing a high degree of flexibility in putting together a customized package. Mix-and-match hardware is customized through the use of

auxiliary programs. WIN\_TGS uses a Los Alamos-developed handshaking protocol to communicate and share control of the scanner with registered auxiliary programs used for automatic sample loading, collimator control, and transmission source control. This open design allows WIN\_TGS to be used without modification in scanners that require specialized or one-of-a-kind designs for these functions.

WIN\_TGS itself is highly customizable with regard to sample types that can be scanned, the isotopes that can be assayed, and the scanning protocols supported. In addition to several built-in abstract scanning protocols, users can readily implement their own customized scanning protocols. User-defined protocols can be written as ASCII files using the Los Alamos-developed TPR language, a high-level, easy-to-use, interpreted computer language for specifying data acquisition and motor motion sequences. While mainly intended for controlling TGS or SGS systems, WIN\_TGS can also be used as a generic stepper-motor/data acquisition controller and has, as an installation option, the ability to use an

alternative main window control panel that is not tied to the TGS (up-down + left-right + rotation) motor configuration. In that mode of operation, user-written scan protocols can control an arbitrary number of stepper motors and multichannel analyzers in arbitrary scanning sequences. This capability allows WIN\_TGS to be used, for example, to control a robotic sample analyzer.

The WIN\_TGS scanning protocol for SGS is in many ways superior to that used in conventional SGS scans, where a single spectrum is collected and analyzed on each pass on each layer of the drum. WIN\_TGS collects total-layer spectra in the same way, but also collects some number *GrabsPer-Layer* of data grabs on each layer, giving a profile of the radial distribution of matrix materials (for the transmission pass) or radionuclides (for the emission pass). This additional "spatial" information can be evaluated to assess the uniformity of the sample and, for non-uniform samples, the uniformity of mixing of the various isotopes that are present. The latter is of particular significance for isotopic analysis because some methods assume an intimate mixing of isotopes in computing isotope fractions.

Following the current practice in SGS software, WIN\_TGS uses a caste system to simplify the development of site operating and quality assurance plans by restricting access to advanced functions.

There are three levels of access in the TGS caste system. These are

- system installer,
- technical supervisor, and
- system operator.

These three levels are manifest in the overall design of WIN\_TGS. At the lowest level (operator) there is a simple, button-operated control panel for routine assays. At a higher level (supervisor) there is a drop-down menu for setting various configuration items and executing advanced functions. A password is required to access this supervisor's

menu. At the highest level (installer) there are initialization files that must be edited and program components that must be mixed and matched.

We recently published an 83-page operator's manual<sup>51</sup> to guide operators and system supervisors in the use of WIN\_TGS. This work completes our development of WIN\_TGS as a separate lifecycle. Future upgrades and development will be performed as needed under related OSS lifecycles or with funding from non-OSS sources.

**Acoustic Resonance Spectroscopy to Localize Holdup (Dan Vnuk and Chad Olinger, NIS-7).** The objective of this task was to study the feasibility of using acoustic techniques to monitor process equipment for coatings that may indicate locations where nuclear material has been deposited (holdup). If successful, this technique will reduce the time required for holdup measurements, which will reduce costs and personnel radiation exposure while increasing confidence in and accuracy of holdup measurements.

### Technical Highlights

Ultrasonic standing waves can be established in the walls of many nuclear material containers and most processing equipment. Holdup and corrosion change the reflection characteristics at the internal boundary, changing the frequency and amplitude of the standing wave. Scanning appropriate acoustic equipment across the surface of such an item can thus be used to determine whether there is a potential problem with holdup or corrosion and can pinpoint locations of particular concern for further analysis. This could provide a useful screening tool for conventional radiation-based holdup measurements where radiation-based screening measurements are constrained by equipment geometry or high background radiation fields.

During June and July we tested the use of ultrasound in detecting simulated holdup on the surface of a metal plate,

demonstrating the proof-of-concept. Materials used to simulate holdup included vacuum grease, soot, photo resist, and clear plastic tape. These materials significantly reduced the amplitude of ultrasonic standing waves established in the plate thickness. Edges of the holdup could be detected from the "outside" by scanning the dual-element transducer over the surface and monitoring for amplitude changes in the standing wave. This technique should prove useful in detecting suspect holdup and specifying the geometry so that appropriate corrections can be made to complementary radiation-based holdup measurements.

In conjunction with this effort, we have tried a variety of acoustic coupling materials to enhance the detection efficiency. We will investigate couplants that do not leave a residue on the equipment because this would be undesirable in most operating environments. Also, we will investigate the use of EMATs (Electro Magnetic Acoustic Transducers) that can make non-contact measurements, eliminating the need for any type of coupling material.

An alternate technique that we will investigate in FY96 involves the use of pulse echoes instead of resonant ultrasound to detect areas of holdup. The pulse echo technique would rely on amplitude changes in the reflected pulse to detect areas of holdup. If the type of holdup present has a high acoustic impedance, the amplitude change would be large because energy from the pulse would be transferred into the holdup material. In this case the technique could be extremely effective.

A technique to determine the thickness of holdup deposits will also be investigated. The technique will use an ultrasonic swept frequency method. This technique gives a series of peaks representing resonances being set up within the wall of the pipe and in the holdup as well. The theoretical model suggests that the thickness of holdup can be calculated from the speed of sound in the material and the time between successive resonant peaks.

We developed software to estimate holdup thickness based on the acoustic model and acoustic interferometry measurements. To date, these results address an idealized system in which the holdup thickness is carefully controlled. This model and the associated software will be used in the field test to be conducted during FY96.

**Acoustic Resonance Spectroscopy with Intrinsic Seals (Dan Vnuk and Chad Olinger, NIS-7).**

### Technical Highlights

All containers for SNM can vibrate at a number of natural frequencies. These natural frequencies reflect a complex function of the container geometry and a number of parameters of the fill material such as its volume, acoustic velocity, density, viscosity, and amount of contamination. ARS measures these natural frequencies by exciting the body with one transducer and listening for the vibrational response with another. A range of frequencies appropriate for many containers of interest is swept in just 10 seconds, and the acoustic spectrum is accumulated and displayed in real time by the ARS system, which is incorporated into a lap-top computer. These features combine to make the system highly portable and allow rapid, reproducible measurements.

No two acoustic spectra from different containers are ever exactly alike. Therefore, ARS can "fingerprint" filled containers and establish intrinsic seals. Containers can be identified by their ARS fingerprint. In the intrinsic seal application it is possible to determine whether the container has been opened or contents removed by comparing a fresh spectrum to the reference spectrum for that container. This comparison between spectra is easily understood when it is reduced to a single number that is normalized to be between zero and one. Figure 29 shows the population distributions established for one method of comparing spectra. This result represents an optimized case,

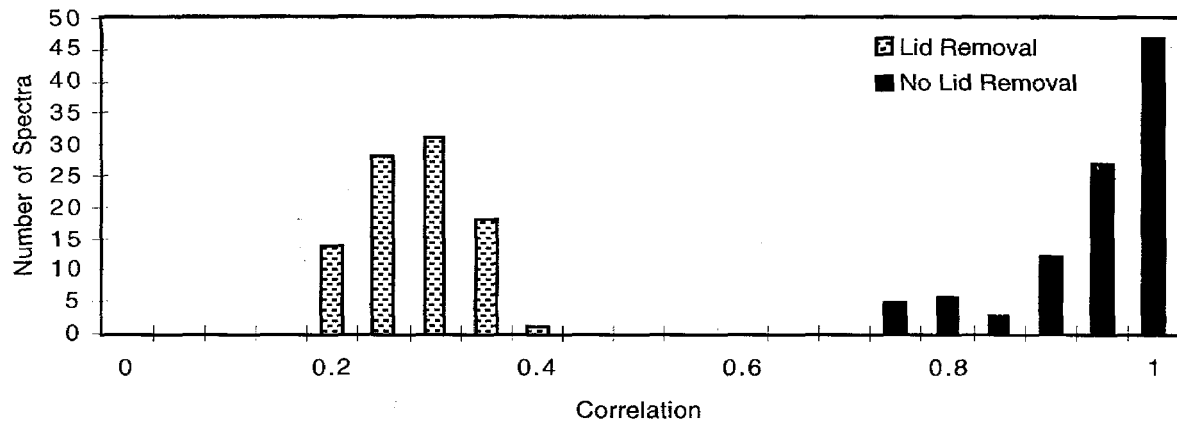

Fig. 29. Use of peak comparison to detect lid removal.

where the containers were in an air conditioned room and were not disturbed between measurements, except when "tampering" was intentionally introduced. In this situation we observe clean separation between the cases where tampering occurred between measurements and where tampering did not occur between measurements.

We completed a field test of the ARS intrinsic seals application in KIVA 3 at Los Alamos National Laboratory. In this test we selected six 35-gal. drums, six 55-gal. drums and six double-height drums for tests where the containers remained in place between analyses and four additional 55-gal. drums that were moved between each measurement to simulate normal material handling.

A total of 482 spectra were taken of these containers over the period of approximately one month. Four of the containers were opened (this number was limited by ES&H considerations), approximately halfway through the experiment to determine whether the acoustics technique can be used to indicate tampering.

Analysis of the data obtained in the operating environment suggests that reproducibility was a problem. This was due in part to sensitivity to transducer repositioning. Also, the containers used in the experiment had irregular surfaces due to mild oxidation, which may have contributed to poor reproducibility as

well. The data revealed that we can detect simple movement of the containers within the storage area. This may or may not be desirable depending on the particular storage situation. Our data indicated that lid removal can be detected in an operational environment. However, the analysis of the data was complicated by the presence of nuisance effects, mainly sensitivity to transducer placement.

Near the end of this fiscal year we began experimenting with low-frequency excitation (200–1200 Hz). Experimentation showed that spectra obtained using lower frequencies had desirable qualities. Use of low frequencies greatly reduces nuisance effects, such as sensitivity to transducer placement, while preserving the ability to detect tampering. Figure 30 shows two populations representing cases where no tampering occurred between measurements, but where the transducers were randomly replaced 2–3 mm from the position where the baseline measurement was taken. Low-frequency measurements show a much more consistent correlation with the baseline spectra.

To accommodate the lower frequency range, some changes were made to the analysis software. The comparison algorithm was changed to incorporate a tighter tolerance. This algorithm lowers the overall correlation between similar spectra but increases the normalized

separation between similar and dissimilar spectra. Figures 31 and 32 are histograms representing an experiment similar to the one in Fig. 29. Both figures represent the same data, but a different discriminator was used in each case. A comparison of Figs. 31 and 32 shows that the tighter tolerance allows us to see the separation that indicates tampering occurred between the two populations.

If this project is resumed, future field testing will be greatly facilitated by the combined use of a lower frequency and tighter comparison algorithms.

**Non-Sensitive Attribute Measurements for Weapons Components** (M. C. Miller, NIS-5; R. C. Byrd, NIS-2; M. S. Krick, P. A. Russo, N. Ensslin, S. Bourret, R. S. Biddle, G. Walton, NIS-5; W. C. Feldman D. Morley, NIS-1; and M. W. Johnson, NIS-6). We are developing instrumentation to enable high-confidence verification measurements of weapons components without revealing design information. This type of measurement could be required in bilateral weapons dismantlement agreements as well as part of inspections under the U.S. voluntary offer to place excess defense material under IAEA safeguards. A laboratory prototype instrument, the Multiplicity Fingerprint System, has been built and successfully tested using a variety of radiation sources.

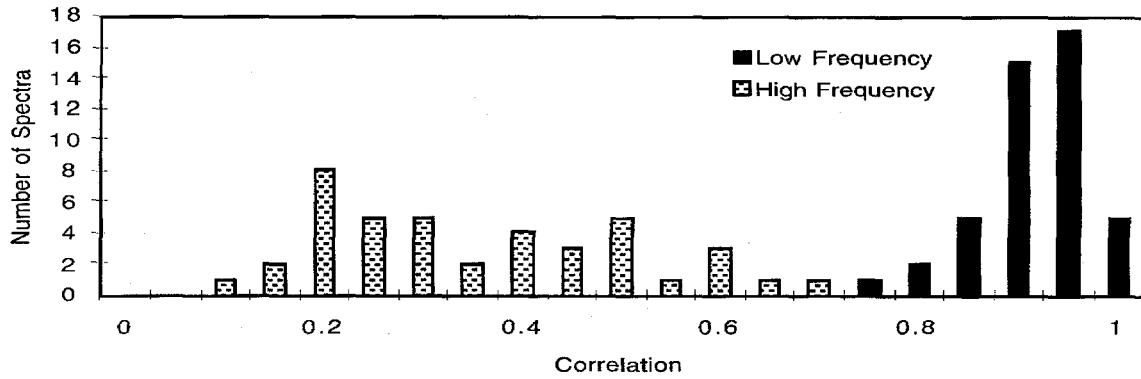

Fig. 30. Comparison of low-and high-frequency measurements where no tampering occurred between measurements but transducer placement varied from the baseline measurement location by 2-3 mm.

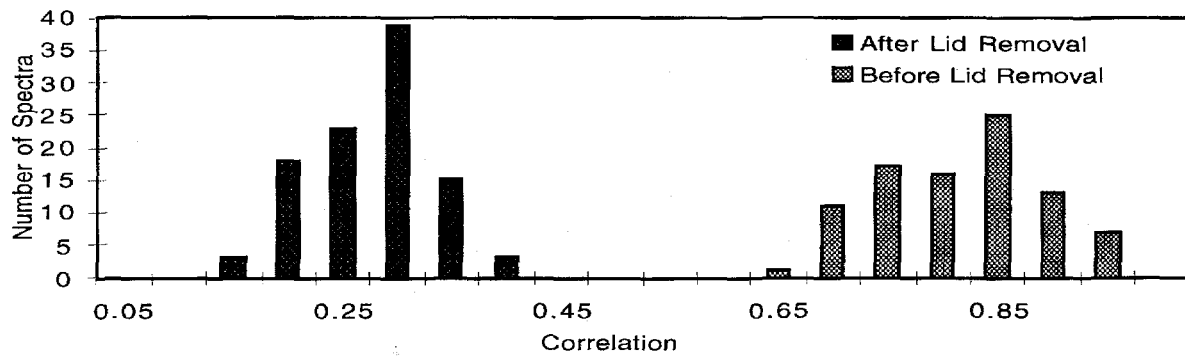

Fig. 31. Comparison of spectra using 2-Hz discriminator.

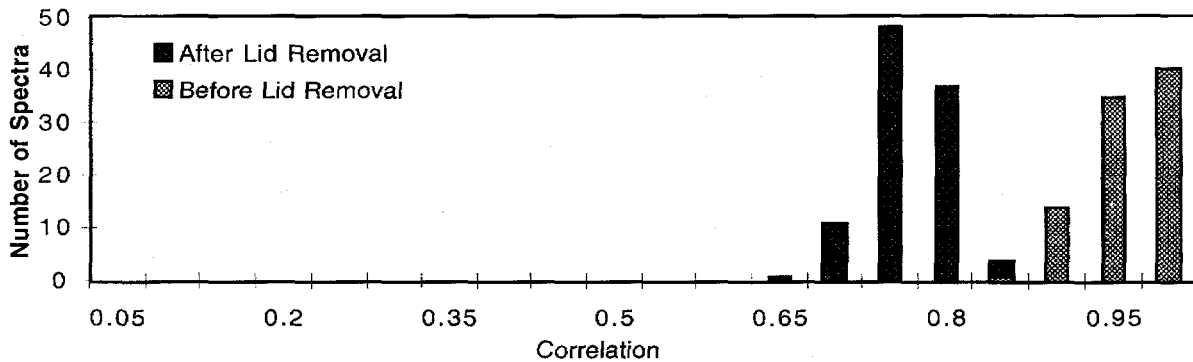
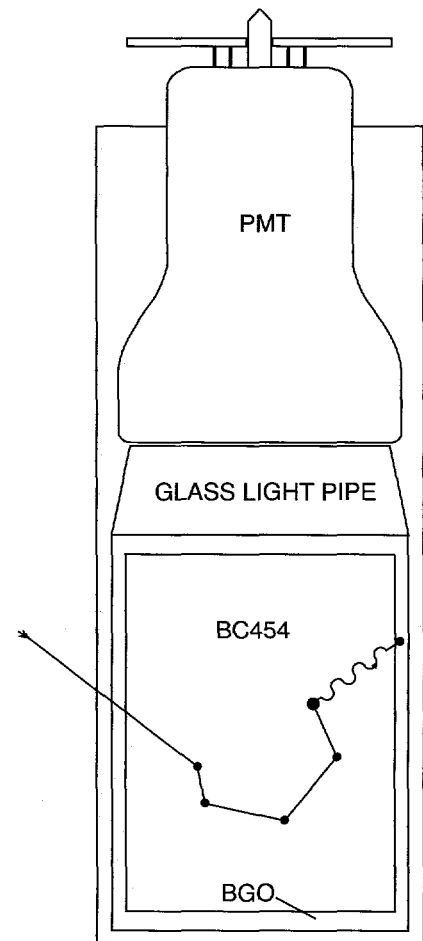

Fig. 32. Comparison of spectra using 8-Hz discriminator.

Verification of nuclear-weapons dismantlement activities poses many challenges, particularly because of the need to satisfy two contradictory goals: measurements should have enough sensitivity to provide a unique signature of the component, yet be sufficiently non-specific as to protect weapons design information. Traditional NDA approaches will certainly be too revealing, but procedures that severely restrict or eliminate radiation measurements may be too insensitive to the most relevant parameter—the presence of fissile material. One potential solution is a multiplicity “fingerprint,” which contains both gamma-ray and neutron information that has been irreversibly scrambled by the physics of the detection process. Such an approach is embodied in the Multiplicity Fingerprint System, which is currently being pursued by combining detector technology developed for space applications with electronics and analysis developed for nuclear materials safeguards. Figure 33 shows the prototype instrument with a 30-gal. drum in the measurement position.

This new technique inseparably combines the gamma-ray and neutron information to explicitly avoid the classification proscription against revealing separated neutron or gamma-ray data. The detector being investigated for this

purpose provides a deliberately complicated response to different nuclear radiations. The active element combines boron-loaded plastic<sup>52,53</sup> (available from Bicron Corporation as BC454) with bismuth germanate (BGO). The two scintillators are optically coupled (phoswiched) so that the light output is collected by a single photomultiplier tube. This configuration allows capabilities that neither scintillator has alone, while also providing the desired mixing of radiation responses. For fast neutrons, the plastic scintillator usually produces a pair of light pulses, the first from proton recoils and the second from the capture of the scattered neutron via a  $^{10}\text{B}(n,\alpha)$  reaction. This scatter-capture process has a die-away time of  $\sim 2 \mu\text{s}$ . Slow neutrons can also capture on  $^{10}\text{B}$ , but they produce only the capture pulse, not the proton-recoil signal. Additionally, the plastic scintillator responds to gamma radiation, primarily through Compton scattering. Bismuth germanate is gamma-ray sensitive, although with better energy resolution, a lower quantum yield, and a much slower time response relative to the plastic scintillator. The BGO also provides some neutron response because the  $^{10}\text{B}$  capture reaction produces a 478-keV gamma ray. Figure 34 is a schematic drawing of a fast neutron scattering and subsequently being captured. Two pulses are



*Fig. 34. Schematic of one of the BC454/BGO detectors showing a fast neutron scattering, which produces a recoil light pulse, and then capturing, producing a pulse in the BC454 and a gamma ray that interacts with the BGO.*

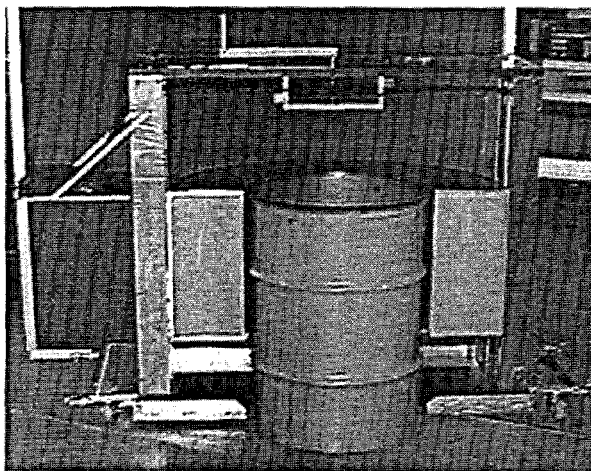

*Fig. 33. Multiplicity fingerprint system with 30 gallon drum in measurement position.*

produced in the process, a recoil pulse due to initial scattering and a pulse due to capture of the neutron by  $^{10}\text{B}$ . The capture pulse has a plastic component arising from charged particles in the  $^{10}\text{B}(n,\alpha)$  reaction and a BGO component due to interaction of the 478-keV gamma ray. Thus, the combination of boron capture and the BC454/BGO phoswich arrangement provides a detector output that is much more complicated than that of the separate scintillators, particularly in the case of the added response to slow neutrons. Finally, we use a simple window discriminator to

convert the analog output signal into a generic logic pulse that has no direct spectral content. This electronic processing further isolates the operator from the original neutron and gamma-ray information.

The second feature of the proposed technique emphasizes the multiplicity signature provided by nuclear fission. By surrounding the sample with an array of phoswich detectors and summing the outputs, we obtain a digital pulse train that contains time-correlated fission signatures. This combined signal is fed into a multiplicity shift register,<sup>54</sup> which separates the correlated signature from the singles count rate, just as in the traditional assay approach. However, the correlations here differ from those in the conventional case in two important ways. First, the pulse train includes correlations between fission neutrons and gamma rays in all combinations. Second, the instrumental artifacts discussed above, such as the two-pulse fast-neutron response and the scattering of neutrons and gamma rays between detector elements, inject other correlations that further eliminate any straightforward connection to isotopics and masses. In addition, these correlations introduce

specific features that identify the particular component under investigation. The result is a multiplicity distribution that provides a fingerprint unique to the item being measured, while at the same time not revealing sensitive information.

A prototype instrument has been built and successfully tested in benchmark experiments and proof-of-principle measurements at Los Alamos. Figure 35 is a cross section of the detector housing showing the location of the phoswich detectors and surrounding scattering/moderating/shielding materials. Multiplicity fingerprints have been obtained from a variety of sources, including pure gamma rays, single neutrons (alpha,n), and correlated neutrons and gamma rays (fission). Fission sources tested so far are <sup>252</sup>Cf, plutonium oxides and metal, uranium metal, and plutonium and uranium components. The measured signatures from these sources were distinct, and traditional analysis approaches were not able to determine masses. Shown in Fig. 36 are generic results obtained from a variety of radiation sources. The plot axes are doubles/singles and triples/singles and the scale is arbitrary. As can be seen from Fig. 36, gamma

rays have little or no correlation signature, whereas neutrons do. Random neutrons show only mild correlation due to the scatter/capture process. Fission neutrons are more highly correlated with <sup>252</sup>Cf being the most correlated. This is consistent with the larger *n* values of <sup>252</sup>Cf. We are encouraged by these initial results and plan to pursue further measurements and vigorous analyses, both to determine system performance parameters and to ensure that the fingerprint is truly non-sensitive in nature. Reverse-engineering efforts will involve experts in the areas of multiplicity analysis, detector simulation,<sup>55</sup> and weapons design.

**Safety Documentation and Analysis for Safeguards Technology Development (Tom Van Lyssel, NIS-5).** Two of the facilities that house the Safeguards Science and Technology research, development, and training operations have been designated as Nuclear Facilities under DOE STD 1027-92 for hazard classification. As a result, safety analysis and documentation are being prepared in compliance with DOE Order 5480.23 [Nuclear Safety Analysis Reports (SAR), December 1992]. The safeguards program has about two years to generate the required documentation or to request an exemption in nuclear facility classification based on paragraph 3(d)(2) of DOE-STD-1083 (Requesting and Granting Exemptions to Nuclear Safety Rules). We are requesting an exemption. This effort requires extensive input from programmatic personnel, with the assistance of the Los Alamos Risk Management Program (ESH-3). Safeguards buildings that have been designated as Nuclear Facilities are TA-35, Buildings 2 and 27 (primary location of the group's R&D, implementation, administration, and training operations) and TA-3, Building 29, CMR Facility (new location of group's Category I and Category II training operations). Facilities can also be exempted from the Nuclear Facilities list by repackaging some of their sources in containers that meet ANSI

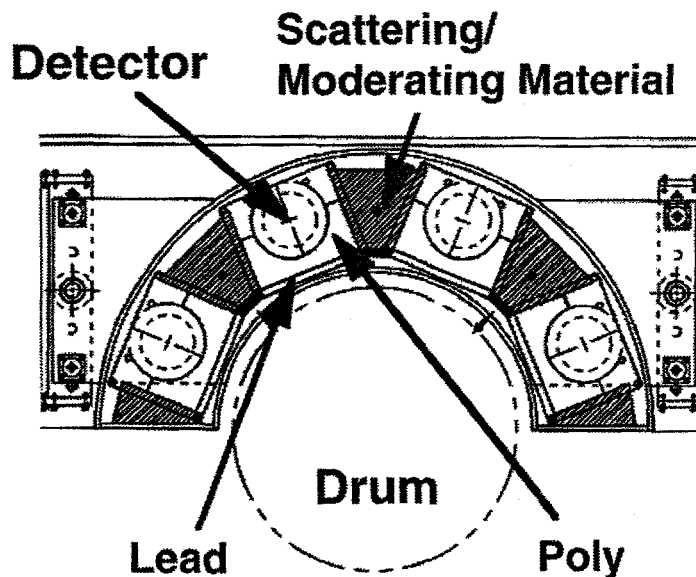

Fig. 35. Cross section of detector housing showing location of phoswich detectors, scattering/moderating inserts, and drum sample.

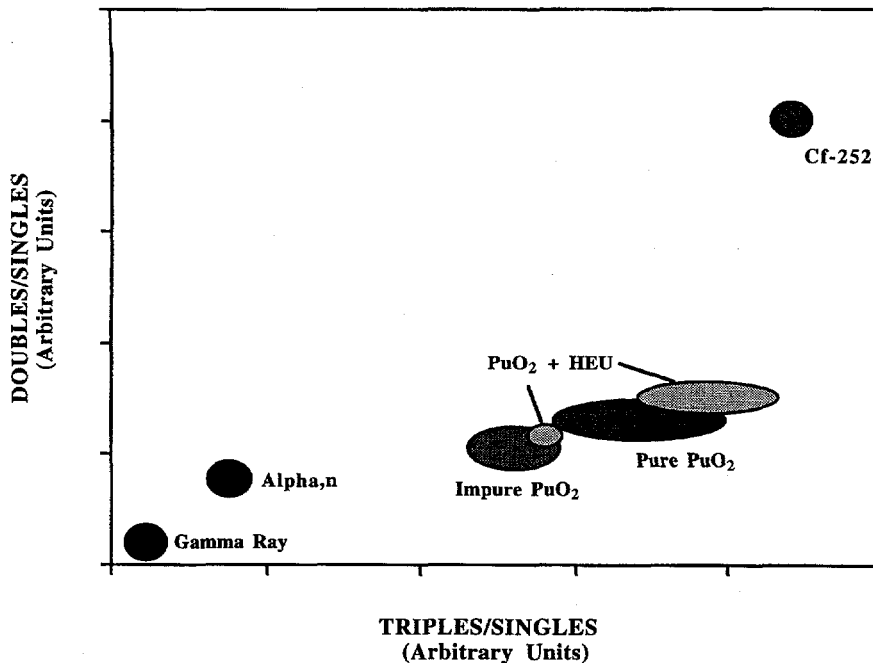

Fig. 36. Multiplicity fingerprint results showing detector response from a variety of radiation sources.

N43.6 as described in DOE-STD-1027. We are also proceeding on this parallel path in case the exemption is not as requested in the Basis for Interim Operations (BIO).

The BIO, which includes a safety analysis for Buildings 2 and 27, was submitted to the DOE on September 1, 1995. A Justification for Exemption section was included in the BIO in an attempt to have both buildings removed from the Nuclear Facilities list. It is our goal to have these buildings classified as Lab Sealed Source Facilities. The BIO was returned to us for more information and was resubmitted on December 7, 1995. If the exemption is granted, a safety assessment will still be required but it will not be as extensive as a Nuclear Facility SAR.

The repackaging of the plutonium sources used in our training program is proceeding. The first step will be the certification of the containers to ANSI standards. This should be completed by the end of January 1996. The first three plutonium sources should be repackaged in these new containers by the end of February 1996. If we are successful

in having our facilities removed from the nuclear facilities list, the repackaging will only be done on sources in need of repackaging for safety reasons. If we are not successful, all plutonium sources will be repackaged in the next two to three years so they can be exempted from the nuclear material inventory.

#### References

1. H. Ottmar and H. Eberle, "The Hybrid K-Edge/K-XRF Densitometer: Principles - Design - Performance," Kernforschungszentrum Karlsruhe report KfK 4590 (February 1991).
2. S.-T. Hsue and M. Collins, "Simulation of Absorption Edge Densitometry," Los Alamos National Laboratory report LA-12874-MS (November 1994).
3. H. Ottmar, H. Eberle, N. Doubek, W. Raab, and J. Parus, "Analysis of Th-U, U-Pu and Pu Solutions with a Hybrid K-Edge/ XRF Analyzer," in *Proc. of the 13th ESARDA*

*Symposium on Safeguards and Nucl. Mater. Manage.* (ESARDA, Ispra, Italy, 1991), **24**, pp. 149-157.

4. S.-T. Hsue and M. Collins, "New Analysis Technique for K-Edge Densitometry Spectra," presented at the American Nuclear Society Fifth International Conference on Facility Operations—Safeguards Interface, Jackson Hole, Wyoming, September 24-29, 1995.
5. T. E. Sampson, G. W. Nelson, and T. A. Kelley, "FRAM: A Versatile Code for Analyzing the Isotopic Composition of Plutonium from Gamma-Ray Pulse Height Spectra," Los Alamos National Laboratory report LA-11720-MS (December 1989).
6. T. E. Sampson, G. W. Nelson, and T. A. Kelley, "FRAM: A New Versatile Gamma-Ray Spectrometry Code for Measuring the Isotopic Composition of Plutonium," *Nucl. Matl. Management* **XIX**, 402 (July 1990).
7. R. J. Friar and T. E. Sampson, "Plutonium Isotopic Abundance Measurements on CBNM NRM 271 Analyzed with the FRAM and MGA Codes," Los Alamos National Laboratory report LA-12309-MS (May 1992).
8. T. E. Sampson and T. A. Kelley, "The FRAM Code: Description and Some Comparisons with MGA," *Proceedings of the International MGA Users' Workshop, 19-20 October 1994* (IRMM, EC-JRC, Geel Belgium) EUR 16163 EN, p. 155.
9. T. A. Kelley, T. E. Sampson, and D. DeLapp, "PC/FRAM: Algorithms for the Gamma-ray Spectrometry Measurement of Plutonium Isotopic Composition," presented at the American Nuclear Society Fifth International Conference on Facility Operations—Safeguards Interface, Jackson Hole,



- Wyoming, September 24–29, 1995; Los Alamos National Laboratory document LA-UR-95-3326.
10. T. E. Sampson, T. A. Kelley, T. L. Cremers, T. R. Konkel, and R. J. Friar, "PC/FRAM: New Capabilities for the Gamma-ray Spectrometry Measurement of Plutonium Isotopic Composition," presented at the American Nuclear Society Fifth International Conference on Facility Operations – Safeguards Interface, Jackson Hole, Wyoming, September 24–29, 1995; Los Alamos National Laboratory document LA-UR-95-3287.
  11. P. A. Russo, M. C. Sumner and D. A. Close, "Scintillator/Solid-State Detector Technologies as Replacements for the Compact Sodium Iodide Detectors," in "Safeguards and Security Progress Report, October 1993–September 1994," D. B. Smith and G. R. Jaramillo, Comps., Los Alamos National Laboratory report LA-12953-PR (August 1995), pp. 19–24.
  12. P. A. Russo, J. K. Sprinkle, Jr., and T. R. Elmont, "Holdup Measurements of the Rocky Flats 371 Precipitator Canyons," Los Alamos Laboratory report LA-10967-MS (1987).
  13. P. A. Russo, R. Siebelist, J. A. Painter and J. E. Gilmer, "High-Resolution Gamma-Ray Methods for Determination of Solid Plutonium Holdup in High-Throughput Bulk-Processing Equipment," Los Alamos Laboratory report LA-11729-MS (1990).
  14. T. R. Wenz, P. A. Russo, M. C. Miller and H. O. Menlove, "Portable Gamma-Ray Holdup and Attributes Measurements of High- and Variable-Burnup Plutonium," in *Proceedings of 4th International Conference on Facility Operations - Safeguards Interface* (American Nuclear Society, Inc., LaGrange Park, Illinois, 1992), ANS Order No. 700168, pp. 226–236.
  15. P. A. Russo, M. M. Stephens and S. C. Bourret, "Compact NaI(Tl) Detectors," in "Safeguards and Security Progress Report, January–September 1989," D. B. Smith and G. R. Jaramillo, Comps., Los Alamos National Laboratory report LA-11914-PR (1990), pp. 20–22.
  16. *Selected ASTM Standards on the Application, Evaluation and Maintenance of SNM Portal Monitors* (ASTM, Philadelphia, PA, 1994).
  17. Paul E. Fehlau, "User's Manual for the PRM-470A Hand-Held Special Nuclear Material Monitor," Los Alamos National Laboratory document 92-79 (December 1992).
  18. K. L. Coop, R. J. Estep. and L. E. Ussery, "Combined Thermal/Epithermal Neutron (CTEN)/TGS Package Monitor," in "Safeguards and Security Research and Development Progress Report, October 1993–September 1994," D. B. Smith and G. R. Jaramillo, Comps., Los Alamos National Laboratory report LA-12953-PR (August 1995), p. 40.
  19. H. O. Menlove, "Description and Operation Manual for the Active Well Coincidence Counter," Los Alamos Scientific Laboratory report LA-7823-M (May 1979).
  20. H. O. Menlove and J. E. Stewart, "A New Method of Calibration and Normalization for Neutron Detector Families," Los Alamos National Laboratory report LA-11229-MS (April 1988).
  21. H. O. Menlove and J. E. Swansen, "A High-Performance Neutron Time-Correlation Counter," *Nucl. Technol.* **71**, 97–505 (1985).
  22. D. G. Langner, M. S. Krick, and K. E. Kroncke, "A Large Multiplicity Counter for the Measurement of Bulk Plutonium," *Proc. of the Institute of Nuclear Materials Management 34th Annual Meeting*, (INMM, Chicago, 1993), pp. 474-479.
  23. T. H. Prettyman, et al., "Demonstration of the Los Alamos Mobile Tomographic Gamma Scanner at the Rocky Flats Environmental Technology Site," Los Alamos National Laboratory document LA-UR-95-1861 (1995).
  24. T. H. Prettyman, et al., "Field Experience with a Mobile Tomographic Nondestructive Assay System," presented at the 4th Nondestructive Assay and Nondestructive Examination Waste Characterization Conference, Salt Lake City, Utah, October 24–26, 1995; Los Alamos National Laboratory document LA-UR-95-3501 (1995).
  25. R. J. Estep, T. H. Prettyman, and G. A. Sheppard, "Tomographic Gamma Scanning to Assay Heterogeneous Radioactive Waste," *Nucl. Sci. Eng.* **118** (1994) 145–152.
  26. T. H. Prettyman, "Impact of SGS Performance on PDP Cycle 1 Standard Design and Implementation," Los Alamos National Laboratory document LA-UR-95-4 (1995).
  27. T. H. Prettyman, R. A. Cole, R. J. Estep, and G. A. Sheppard, "A maximum-likelihood reconstruction algorithm for tomographic gamma-ray nondestructive assay," *Nuclear Instruments and Methods in Physics Research A* **356** (1995) 470–475.
  28. T. H. Prettyman, "Precision Estimates for Tomographic Nondestructive Assay," presented at the American Nuclear Society Fifth International Conference on Facility Operations-Safeguards Interface, Jackson Hole, Wyoming, September 24–29, 1995; Los Alamos National Laboratory document LA-UR-95-3299 (1995).
  29. R. J. Estep, T. H. Prettyman, and G. A. Sheppard, "Tomographic Gamma Scanning to Assay Heterogeneous Radioactive Waste," *Nucl. Sci. Eng.* **118** (1994) 145-152.

30. T. H. Prettyman, et al., "Demonstration of the Los Alamos Mobile Tomographic Gamma Scanner at the Rocky Flats Environmental Technology Site," Los Alamos National Laboratory document LA-UR-95-1861 (1995).
31. T. H. Prettyman, J. K. Sprinkle, Jr., and G. A. Sheppard, "A weighted least-squares lump-correction algorithm for transmission corrected gamma-ray nondestructive assay," *Nucl. Mater. Manage.* **XXII** (Proc. Issue) 682-690 (1993).
32. T. H. Prettyman, J. K. Sprinkle, Jr., and G. A. Sheppard, "Performance of an advanced lump correction algorithm for gamma-ray assays of plutonium," *Nucl. Mater. Manage.* **XXIII** (Proc. Issue) 893-896 (1994).
33. R. J. Estep, "A Preliminary Design Study to Improve Performance in Tomographic Assays," Los Alamos National Laboratory report LA-12727-MS (1994).
34. G. A. Sheppard, T. H. Prettyman, and E. C. Piquette, "Accounting for Segment Correlations in Segmented Gamma-ray Scans," *Nucl. Mater. Manage.* **XXIII** (Proc. Issue), 882-886 (1994).
35. T. H. Prettyman, R. J. Estep, and G. A. Sheppard, "Transmission Corrections for Tomographic Non-destructive Assay," Presented at the 36th annual meeting of the INMM, Palm Desert, California (July 1995) (to appear).
36. R. J. Estep, T. H. Prettyman, and G. A. Sheppard, "Reduction of TGS Image Reconstruction Times Using Separable Attenuation Coefficient Models," Presented at the American Nuclear Society Winter Meeting, San Francisco, California, June 15, 1995; Los Alamos National Laboratory document LA-UR-95-2013 (1995).
37. T. H. Prettyman, R. J. Estep, and G. A. Sheppard, "Development of a Tomographic Instrument for Gamma-Ray Nondestructive Assay," *Trans. Am. Nucl. Soc.* **69**, 182-184 (1993).
38. T. H. Prettyman, "Impact of SGS Performance on PDP Cycle 1 Standard Design and Implementation," Los Alamos National Laboratory document LA-UR-95-4 (1995).
39. P. A. Russo, J. K. Sprinkle, Jr., J. K. Halbig, S. F. Klosterbuer, and S. E. Smith, "Generalized-Geometry Gamma-Ray Holdup Assay," Los Alamos National Laboratory Application Note LALP-94-72 (February 1995).
40. P. A. Russo, H. A. Smith, J. K. Sprinkle, Jr., C. W. Bjork, G. A. Sheppard, and S. E. Smith, "Evaluation of an Integrated Holdup Measurement System Using the GGH Formalism with the M<sup>3</sup>CA," Los Alamos National Laboratory document LA-UR-95-3321 (September 1995).
41. S. E. Smith, J. S. Gibson, J. K. Halbig, S. F. Klosterbuer, P. A. Russo and J. K. Sprinkle, Jr., "The Holdup Measurement System II (HMSII)," *Proceedings, 34th Annual Meeting of INMM*, Vol. 22 (Institute for Nuclear Materials Management, Northbrook, Illinois, 1993), pp. 508-512.
42. P. A. Russo, M. M. Stephens and S. C. Bourret, "Compact NaI(Tl) Detectors," in "Safeguards and Security Progress Report, January-September 1989," D. B. Smith and G. R. Jaramillo, Comps., Los Alamos National Laboratory report LA-11914-PR (1990), pp. 20-22.
43. J. K. Halbig, S. F. Klosterbuer, P. A. Russo, J. K. Sprinkle, Jr., and S. E. Smith, "Advances in Gamma-Ray Field Instrumentation at Los Alamos," Los Alamos National Laboratory document LA-UR-93-2874 (1994).
44. P. A. Russo, J. K. Sprinkle, Jr., and T. R. Elmont, "Holdup Measurements of the Rocky Flats 371 Precipitator Canyons," Los Alamos National Laboratory report LA-10967-MS (1987).
45. P. A. Russo, R. Siebelist, J. A. Painter, and J. E. Gilmer, "High-Resolution Gamma-Ray Methods for Determination of Solid Plutonium Holdup in High-Throughput Bulk-Processing Equipment," Los Alamos Laboratory report LA-11729-MS (1990).
46. T. R. Wenz, P. A. Russo, M. C. Miller and H. O. Menlove, "Portable Gamma-Ray Holdup and Attributes Measurements of High and Variable Burnup Plutonium," in *Proceedings of 4th International Conference on Facility Operations—Safeguards Interface* (American Nuclear Society, Inc., Lagrange Park, Illinois, 1992), ANS Order No. 700168, pp. 226-236.
47. P. A. Russo, H. A. Smith, J. K. Sprinkle, Jr., C. W. Bjork, G. A. Sheppard, and S. E. Smith, "Evaluation of an Integrated Holdup Measurement System Using GGH Formalism with the M<sup>3</sup>CA," Los Alamos National Laboratory document LA-UR-95-3321 (September 1995).
48. P. A. Russo, M. M. Stephens, and S. C. Bourret, "Compact NaI(Tl) Detectors," in "Safeguards and Security Progress Report, January-September 1989," D. B. Smith and G. R. Jaramillo, Comps., Los Alamos National Laboratory report LA-11914-PR (1990), pp. 20-22.
49. P. A. Russo, M. C. Sumner, J. K. Halbig, S. F. Klosterbuer, J. K. Sprinkle, Jr., D. A. Close, and P. N. Luke, "Room-Temperature Gamma-Ray Detectors for Nonproliferation and International and Domestic Safeguards," in this publication, p. 14.

50. P. A. Russo, M. M. Pickrell, K. L. Coop, N. Ensslin, R. Estep, M. C. Lucas, and N. J. Nicholas, "Assessment of NDA Requirements with Emphasis on Measurements of RFETS Residues," Los Alamos National Laboratory document LA-UR-95-3465 (October 1995).
51. Robert J. Estep and Jason T. Cavender, "The WIN\_TGS Software Operator's Manual," Los Alamos National Laboratory document number NIS6-95:0455RJE, Rev. 3 (July 3, 1995).
52. D. M. Drake, W. C. Feldman, and C. Hurlbut, "New Electronically Black Neutron Detectors," *Nucl. Inst. Meth.* **A247**, 576-582 (1986).
53. W. C. Feldman, G. F. Auchampaugh, and R. C. Byrd, "A Novel Fast-Neutron Detector for Space Applications," *Nucl. Inst. Meth.* **A306**, 350-365 (1991).
54. J. K. Halbig, S. C. Bourret, W. J. Hansen, D. V. Hicks, S. F. Klosterbuer, and M. S. Krick, "Portable Shift Register," *Nucl. Mater. Manage.* **XXIII** (Proc. Issue) 487-493 (1994).
55. R. C. Byrd and W. T. Urban, "Calculations of the Neutron Response of Boron-Loaded Scintillators," Los Alamos National Laboratory report LA-12833-MS (December 1994).



*Part II.*

*Integrated Safeguards Systems*

## PART II. INTEGRATED SAFEGUARDS SYSTEMS

**Improved Variance Propagation (T. Burr, C. A. Coulter, and J. Prommel, NIS-7).** This project's goal is to deliver a software alternative to the variance propagation code MAWST (materials accounting with sequential testing).

### Background

Variance propagation is straightforward. It is not very technically challenging, but it is "messy." It is the best way to interpret a material balance (MB) but it is not a "cureall." There are difficulties with any interpretation of an MB, such as holdup and incorrect measurement error models.

The DOE has two main computer codes to perform variance propagation:

- a. VP uses "forms" like  $M=VC$  and  $M=WC$  and assigns "stream averages" values to all items in a strats. VP is very useful for "system studies," but is not as useful for actual operations where there can be considerable fluctuation about stream averages.
- b. MAWST uses no "forms," but must express any material balance as a sum of products of sum of products. And in that form, analytical variance propagation was done by hand, then coded into MAWST.

A third computer code is under development under funding for this project: MABSIM (materials accounting by simulation). MABSIM will use no "forms" and will estimate the variance of an MB (or sequence of MBs) by simulation.

All DOE sites that handle SNM are required to perform variance propagation. MAWST is the only available general software tool that can be used to perform variance propagation. MAWST is used by Savannah River and Argonne but is awkward to use and, for nonstandard situations, requires considerable effort involving what has become known as "pseudo-measurements." This

awkwardness is partly due to two limitations: (1) only one kind of random error is allowed for each measurement, so sampling error is treated via a pseudo-measurement, and (2) the input measurement file is, at best, cryptic because of the need to express any MB as a sum of products of sum of products. Despite these two limitations, MAWST is a very good product, and it is NOT our intent to ever replace it. Rather, we plan for MABSIM to be used as a second way to estimate the variance of an MB so that MAWST results can be verified.

In September 1995, a pre-release version that runs under Windows 3.1 was tested at Savannah River. We also maintain a version for testing that runs under UNIX. We have found, what we hope is, a minor bug in the Windows 3.1 version, and that bug is being addressed during FY96.

**LANMAS Development (J. Claborn, J. Smith, and M. J. Roybal, NIS-7; M. Boor, CIC-12).** The core software for the Local Area Network Material Accountability System (LANMAS) will provide the framework of a network-based nuclear material accountability system. It tracks the movement of material throughout a site and generates the required reports on material accountability. LANMAS will run in a client/server mode. The database of material type and location will reside on the server, while the user interface runs on the client and accesses the server via a network. The LANMAS core can be used as the foundation for building required materials control and accountability (MC&A) functionality at any site requiring a new MC&A system. An individual site will build on the LANMAS core by supplying site-specific software.

Westinghouse Hanford Corporation and Los Alamos National Laboratory began developing LANMAS in 1991. This collaboration produced the architecture and foundations used in the

Sandia National Laboratory LANMAS which was implemented at Sandia in 1994. Los Alamos National Laboratory has been funded by DOE/Office of Safeguards and Security to develop a core LANMAS.

### Project Lifecycle

Los Alamos National Laboratory has adopted the software lifecycle model consisting of the following phases for the development of LANMAS.

#### Requirements Phase

In the requirements phase, the software development is planned and the requirements are defined and documented. Requirements are gathered from the various DOE Orders, particularly 5633.3, 4, and 5. Requirements are also gathered from discussions with the various DOE sites. To date, discussions have been held with materials accountability personnel at the Westinghouse Savannah River Site, Pantex, INEL, Los Alamos, Sandia National Laboratory, Oak Ridge Y-12 plant, Westinghouse Hanford Corporation, and LLNL. The software development plan is documented in the LANMAS Software Project Management Plan. The Software Requirements are documented according to IEEE Standard 830-1984, Guide to Software Requirements Specifications. The first draft of the Software Requirements Specifications was released in June 1994. Interested sites met to review the requirements document. The draft version was revised and released. The released version has gone through two other revisions and a review by the independent verification and validation (IV&V) team.

#### Design Phase

During the design phase, the requirements are expanded into a system design that addresses each of the requirements. The design specifies the working

plans for the various software components, interfaces, functions, data structures, and data flows. The design phase is aided by the creation of a prototype that clarifies the requirements. This preliminary design is documented in the Software Design Description according to IEEE Standard 1016-1987, "Recommended Practice for Software Design Descriptions." The initial draft of the preliminary design was released in September 1994. It was reviewed in Los Alamos and expanded into the detailed design, which was reviewed at each interested site. The detailed design is now being reviewed by the IV&V team.

### Code Phase

The code phase includes the transformation of the software components identified in the design phase into coded, tested units. The various components are then assembled into an integrated system that is now in beta release. The beta version is installed at WSRC, INEL, ANL-West, RFETS, and Hanford.

### Testing Phase

During the testing phase, the integrated system is evaluated to determine whether or not the requirements have been satisfied. The testing is documented in a test plan results document according to IEEE Standard 829-1983, Standard for Software Test Documentation.

The Acceptance Test Plan was completed. The test procedures are now being developed by the independent verification and validation team.

### Core Functionality

The initial release of the LANMAS core includes the following functions.

- Material movements, external shipments, and receipts
- Modifications/Adjustments—splits, combines, decays, and project number changes
- Containerization of items

- Nuclear Material Management and Safeguards System (NMMSS) reporting
- Physical inventory support functions
- Standard and ad hoc queries and reports
- Complete item transaction history
- System maintenance and administration functions
- On-line user help functions.

### Core And Site-Specific Relationship

An individual site will build on the LANMAS core by supplying site-specific software. Site-specific software will interface with the LANMAS core through the LANMAS core database and by invoking LANMAS core user interface routines.

### Major Components and Interfaces

A materials accountability system built on the LANMAS core will consist of the following major components.

- Site-Specific MC&A Software: Developed by each site to account for local work and business culture
- User/Site-specific Database: Supports the site-specific software
- LANMAS Core User Interface Routines: Supplied with the core LANMAS. They may be used as is, invoked from site-specific software, or used as the basis for the site-specific software
- LANMAS Core Database: Supports the LANMAS core user interface routines
- LANMAS Core Support Functions: Support the operation of the database.

### Site-Specific Customization

When the LANMAS core is delivered to an implementing site, the LANMAS core project team will work closely with the site LANMAS implementors to customize the core for each

site. This level of interaction can range from custom function development to educating the local implementors about LANMAS so they can develop site-specific functions. When the LANMAS core is delivered, a full set of documentation is included.

**LANMAS Implementation (J. Claborn, J. Smith, M. J. Roybal, NIS-7; and M. Boor, CIC-12).** In June 1994 the first beta delivery of the LANMAS core software was made to Westinghouse Savannah River Site. The LANMAS team supplied two people to install the operating systems, set up the network, and install the database and front-end software. Since that initial installation, the process has been repeated at INEL, ANL-West, Hanford, and Rocky Flats.

**Technical Assistance to DOE Headquarters (N. R. Zack, D. D. Wilkey, and K. E. Thomas, NIS-7).** This ongoing project provided broad-based technical support to DOE's Office of Safeguards and Security (OSS). This project was founded to be a technical resource that did not exist within the normal capabilities at the DOE OSS. Specifically, direct hands-on operational experience in nuclear materials processing, recovery, stabilization, disposal, and safeguards and security was not adequately represented in OSS to support resolution of policy and technical issues. Personnel supporting the task were routinely called upon to address a variety of domestic and international safeguards and security issues involving all phases of nuclear materials. Generally, the task called for support to issues that included the following: preparing and implementing policy and guidance; handling, assaying, and safeguarding waste; integrating international and domestic safeguards at Departmental facilities; coordinating safeguards and security interests; processing, recovering, stabilizing and handling nuclear materials; managing and reporting materials; and designing and implementing safeguards. Adequate space is not available to provide

information on all issues addressed by this task. However, some specific examples of technical support provided to OSS can be modestly discussed.

Preparation of technical position and information papers addressing safeguards and security issues was a major activity in this task. Safeguards associated with materials bearing high concentrations of Pu-240 had to be reconsidered after the material was declared waste and safeguards were terminated. Issues concerned reinstating safeguards, facility procedures, and possible disposal options where termination of safeguards could be reconsidered. Los Alamos headed a two laboratory project to prepare input for a high-level report for the U.S. and Russian Presidents. This support highlighted OSS sponsored safeguards and security technology and its implementation used to identify and counter malevolent threats and to help form a protection program for Departmental nuclear materials. Policy and guidance for safeguarding wastes has received a greater emphasis with decontamination and decommissioning activities at many DOE nuclear sites. Wastes generated in associated activities place a greater strain on operational safeguards activities and relevant guidance. These issues were addressed in reports discussing safeguards termination and potential technology for recovering nuclear materials from those wastes. Plutonium bearing materials that are being stabilized for ultimate long-term disposition presented issues associated with the disposal of materials as waste and long-term storage. Packaging these materials as either wastes or for storage requires that specific packaging criteria be developed and implemented that incorporate safeguards requirements. In this report, two plutonium packaging criteria for materials with more than 50% and less than 50% plutonium were specially reviewed and commented on. Classified directives and technical documents were also reviewed to provide a sound technological safeguards basis

for the nonproliferation and international issues the documents addressed. Marking storage container packages is an important issue for assuring adequate control and accountability of materials for storage and ultimate disposition. Comments were originally provided to documents addressing disposition issues. As a result of those comments, specific technical means and procedures were requested by the Department that would adequately address and resolve those concerns. These recommendations included methods to adequately maintain and track nuclear materials and all associated information regardless of the original location of material packaging.

Nuclear material attractiveness levels were redetermined at several nuclear facilities as part of the OSS goal to reduce operational safeguards and security costs. At several facilities, the recommendations decreased overall protection costs without an unacceptable increase in nuclear material risks. Preparation of a special technical paper concerning poorly measured and unmeasured materials at Departmental facilities resulted in important issues being brought before the Fissile Material Assurance Working Group for consideration. Preliminary consideration for constructing and operating an OSS fissile material storage facility was addressed and appropriate issues raised. The design and operation of an OSS national storage repository was identified to be a cost-effective approach that would also reduce the effect of political decisions for locating and operating the facility.

As the final example, a paper was prepared that discussed OSS applications and support roles for global nonproliferation activities. The paper noted that the technical capability for furthering nonproliferation goals resided in two national laboratories, Los Alamos and Sandia, but that OSS had an important role in fostering development and application of safeguards and security technology, policy, and appropriate applications.

**Policy and Technical Issues for Adapting DOE Safeguards to International Inspections (N. R. Zack, NIS-7).** In September 1993, President Clinton offered to place excess fissile materials under international safeguards by the IAEA to set an example for the rest of the world to follow. The support of these global nonproliferation initiatives by DOE facilities created areas for potential conflict between existing DOE policy and guidance and U.S. treaty obligations. The implementation of IAEA inspection activities at the sites to support the Presidential initiative has created some confusion by requiring the facilities to comply with both the domestic safeguards and security requirements and international treaty obligations. The DOE nuclear facilities have directed their safeguards and security programs to protect against theft/diversion by an insider or outsider. However, IAEA safeguards are structured to detect material being diverted by the government for an undeclared weapons program. This additional focus for facility safeguards and security programs has produced some procedural and policy/guidance concerns from the inspected facilities. The purpose of this task is to provide the DOE Office of Safeguards and Security with a technical basis for formulating policy and guidance on international inspections of DOE facilities and to recommend modifications to existing policy and guidance to help facilities comply with domestic treaty obligations.

Progress in the first year of the task has been associated with gathering detailed information from Departmental facilities with IAEA inspected fissile materials, participating in US/IAEA working group meetings, and supporting RFETS/IAEA preparations for inspections of RFETS materials. Two limited distribution documents addressing IAEA inspection impacts on Hanford/Westinghouse Hanford Company (WHC) and Y-12/Lockheed Martin Energy Systems have been issued. This information was obtained from meetings and interviews



with people involved with MC&A, personnel security, operations security, technical surveillance counter measures, counterintelligence, physical security, and computer/information security personnel. The facilities encountered the following difficulties (among others): communication problems with Departmental offices, transmission of classified information to the IAEA, inspection property and documents belonging to IAEA inspectors, badging of inspectors, protection of security and monitoring systems, establishing flexible material balance area (MBA) boundaries to support IAEA assay and sampling requirements, NMSS reporting requirements, and status of IAEA inspectors. Additionally, recent DOE/OSS policy and guidance that initiates cost-savings, supports worker radiation exposure reductions, and decreases safeguards impacts upon operations cannot be fully implemented due to IAEA monthly and annual inspection activities.

A report has been prepared concerning Savannah River Site (SRS) preparations for IAEA inspections and the safeguards and security impacts that they have identified. Preliminary discussions have been held with RFETS personnel as they prepare for IAEA inspections scheduled for late calendar year 1995. The IAEA has not started inspections at either site. The facilities are early in the implementation cycle of international inspection activities.

A summary has been prepared that identifies impacts from the first annual physical inventory by the IAEA on materials at the Hanford/WHC storage facility. While some of the problems identified in the initial meetings are still present, the lack of specific guidance prior to completion of the facility attachment appears to produce conflicts when complying with the existing safeguards policy. This task will be completed in mid-FY96 with the issuance of a formal report recommending improvements to the safeguards and security policy and guidance to support international inspection activities on DOE facilities.

**Guidance Manual for Nuclear Material Categorization (D. D. Wilkey, NIS-7).** The goal of this project is to develop more detailed and flexible guidance on the determination of attractiveness levels for SNM than is provided in DOE Order 5633.3B, Control and Accountability of Nuclear Materials and its guide. The approach taken is to identify types/forms of SNM requiring a determination of attractiveness level and provide the technical basis for making such determinations.

The DOE graded safeguards approach, as described in DOE Order 5633.3B, requires the determination of category levels of nuclear material locations to establish protection requirements for these locations. A critical parameter related to category determination is knowledge of the attractiveness level of the nuclear material with respect to use in a nuclear explosive device. DOE Order 5633.3B and its guide provide the policy basis for determining the attractiveness level of various forms and types of SNM; however, these requirements and guidance are necessarily general and sometimes based on arbitrary criteria. Currently, there are large quantities of nuclear material on inventory within the DOE that need attractiveness determinations to ensure appropriate protection controls. Specific forms of these materials include materials in matrices requiring special processing, irradiated SNM that does not meet criteria for self-protecting, low-concentration SNM, SNM as numerous small items, and bulk non-portable SNM items. Consequences of failing to meet this need include possible inappropriate levels of protection for some SNM and/or excessive expenditure of resources.

During FY95 a questionnaire was developed and used concerning materials on inventory that needed a review of attractiveness level. A database was developed to collect and analyze the inventory data. The database was sorted to organize the data by material types and forms and a summary list was

provided to DOE. Ten DOE facilities responded identifying >800 kg of enriched uranium and >5000 kg of plutonium in forms requiring attractiveness level review. Material forms identified included fuel materials (both irradiated and unirradiated), process residues, alloys, and SNM in various matrices. An initial review of the attractiveness level assignment for the material identified by the field was performed, and a set of factors that could be used to mitigate the attractiveness level assignment were identified. Preparation of the draft guidance manual for material attractiveness was initiated.

In addition, during FY95 we also responded to requests to perform attractiveness level reviews of specific materials on inventory at the Portsmouth Gaseous Diffusion Plant, the Savannah River Site, the Westinghouse Hanford Site, and Sandia National Laboratories. Reports were prepared for each of the reviews.

Work to be done during FY96 includes refining the initial attractiveness level review, completing the draft manual for material attractiveness guidance, resolving comments on the draft manual, and preparing the manual in final form.

**Seminar on Materials Accounting for Nuclear Safeguards (D. D. Wilkey, NIS-7).** The Safeguards Systems Group presented the seminar on Materials Accounting for Nuclear Safeguards on March 13-17, 1995. Eighteen individuals participated in the seminar. Two participants were from NRC-regulated facilities, the remainder were from DOE and DOE contractor organizations.

**Automated Anomaly Detection (A. Zardecki, NIS-7).** The purpose of the anomaly detection project is to develop, test, and implement a methodology to automate real-time data analysis of SNM in process and in storage. The computer program that accomplishes this objective is based on a library of rules generated from the available

trends in the SNM accounting system; future trends are then identified by comparing the data with the existing rules, augmented by statistical fluctuations. Once developed and tested, the program is intended to serve the needs of all DOE sites that use nuclear material accounting in any form. Potential payoffs include reduced time and resources needed to perform statistical tests and broad applicability to DOE needs, e.g., treaty verification.

Traditional approaches to nuclear materials control relied on statistical decision analysis where the existence or nonexistence of material unaccounted for (MUF) was determined from noisy observations and on-hand inventory. The standard techniques include statistical tests, such as Page's test, and the Kalman filter model. With the advent of new techniques in pattern recognition that supplement the conventional Bayesian approaches, interest has been renewed in anomaly detection in the context of nuclear safeguards.

For most real-world control and signal processing problems, the information concerning design and evaluation can be classified into two kinds: numerical information obtained from sensor measurements and linguistic information obtained from human experts. Generally, neural control is suited for using numerical data pairs (input-output pairs) whereas fuzzy control is an effective approach to using linguistic rules. When fuzzy rules are generated from numerical data pairs, the two kinds of information are combined into a common framework.<sup>56</sup>

As compared to neural networks, the fuzzy controllers can operate in real time; their learning process does not require many iterations to converge. For this reason fuzzy controllers deserve their legitimacy in time-series forecasting, where we want to detect and identify trends in real time. From the standpoint of mathematics, both neural networks and fuzzy controllers stand on a solid footing: they can be viewed as universal approximators. The usefulness of fuzzy controllers in

nuclear safeguards applications has been demonstrated by the author.<sup>57,58</sup>

Fuzzy logic is a powerful, yet straightforward, problem-solving technique with widespread applicability, especially in the areas of control and decision making. In general, it is most useful in handling problems not easily definable by practical mathematical models.

An important part of fuzzy logic centers on the use of fuzzy if/then rules in which the antecedents, consequences, or both are fuzzy rather than crisp. For example, expressed as a collection of fuzzy *if/then* rules, the relation between three variables  $X$ ,  $Y$ , and  $Z$  may be described as

- if  $X$  is large and  $Y$  is not very small then  $Z$  is medium,
- if  $X$  is small and  $Y$  is medium then  $Z$  is large, and
- if  $X$  is very small and  $Y$  is large then  $Z$  is medium,

in which the linguistic values small, medium, and large are fuzzy sets. The if/then rules are also called fuzzy associative memory (FAM) rules. Figure 37 illustrates the FAM architecture.

The FAM system maps numeric data into numeric data by using fuzzy if/then rules at the intermediate states; eventually, the fuzzy output has to become defuzzified to yield the numeric output values.

We report on realistic data from the Plutonium Facility, TA-55, at Los

Alamos National Laboratory. We consider a process in which both the inventory difference and throughput are scaled to the interval (0,1).

We note that the throughput is defined as the arithmetic average of the material fed into a process and the material leaving the same process. The data extending over several years were taken at monthly intervals.

As is evident from Figs. 38 and 39, the temporal behavior of both inventory difference and throughput is too irregular to be of any predictive value. For this reason, we correlate the inventory difference and throughput measurement by forming the product of their forecast errors, as indicated in Fig. 40. The advantage of this approach is that when one of the two factors of the product is small, the product is small too. In other words, only when both the inventory difference and throughput are anomalous, will the product show an anomalous behavior.

Future research will focus on the development of a general purpose computer program that is capable of handling large amounts of input-output data. In addition, the relation of fuzzy control to neural networks as tools in forecasting problems will be elucidated.

**Automated MC&A Database Assessment (Rena Whiteson, NIS-7).** Accurate recording of the processing and transportation of nuclear materials is an essential component of the national

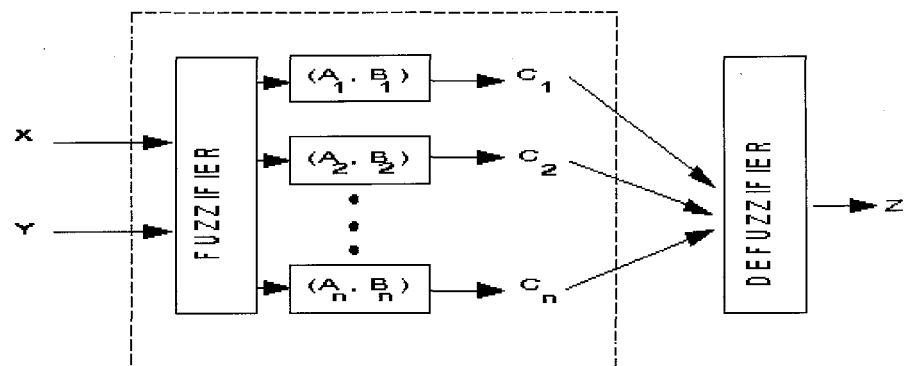

Fig. 37. Fuzzy associative memory (FAM) architecture.

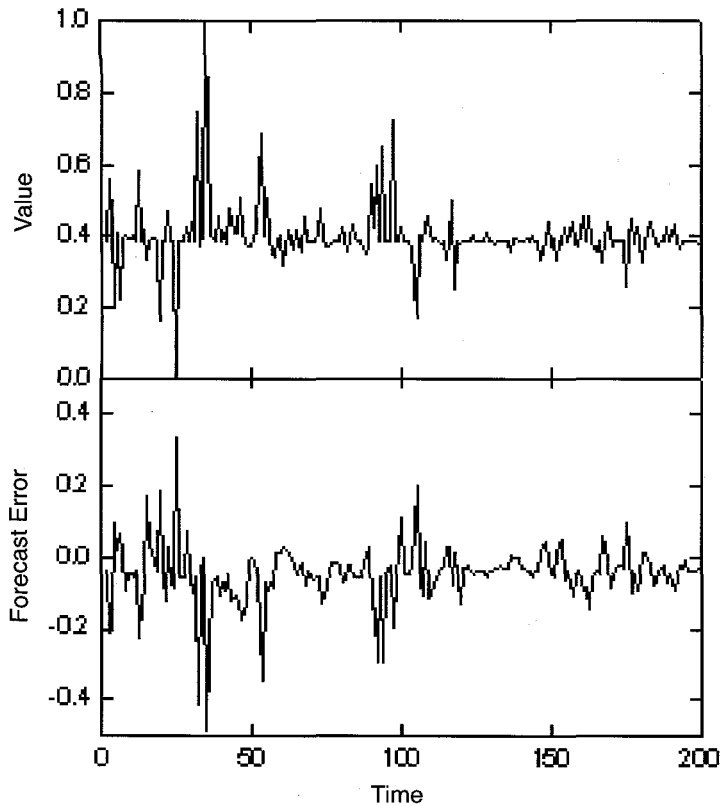

Fig. 38. Inventory difference and forecast error.

mission of reducing the nuclear danger. Large amounts of data describing transactions that involve nuclear materials are collected and stored by nuclear material storage facilities, nuclear chemical processing plants, and nuclear fuel fabrication facilities. To maintain confidence in the integrity of these data, it is essential to identify anomalies in the data bases. Anomalous data could indicate error, theft, or diversion of material. Yet, because of the complex and diverse nature of the data, analysis and evaluation are extremely time consuming and require many expert personnel.

This project applies advanced artificial intelligence and anomaly detection technologies to the detection of errors and anomalies in these databases. By developing automated error and anomaly detection and database assessment tools and applying these tools to MC&A databases, we can provide the means to efficiently and cost effectively assure the integrity of our MC&A data.

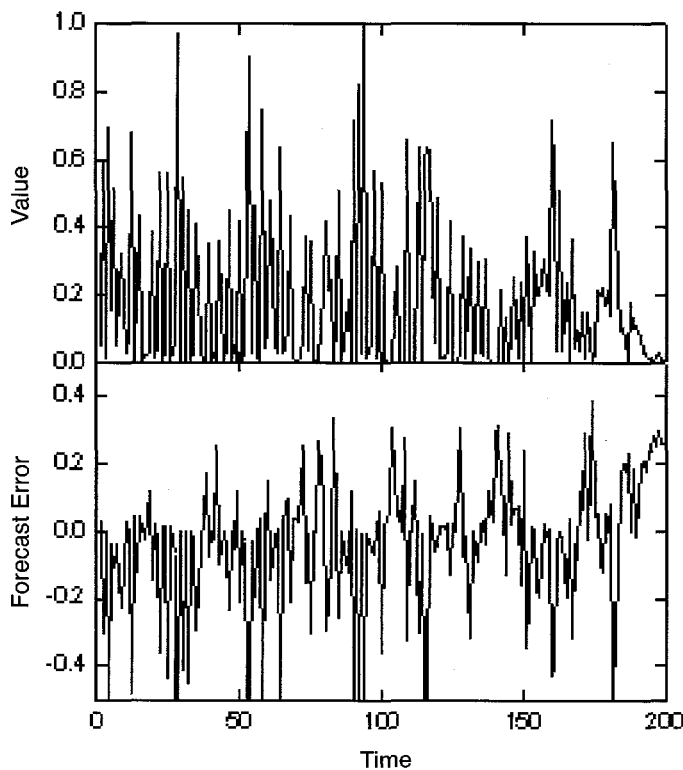

Fig. 39. Throughput and forecast error.

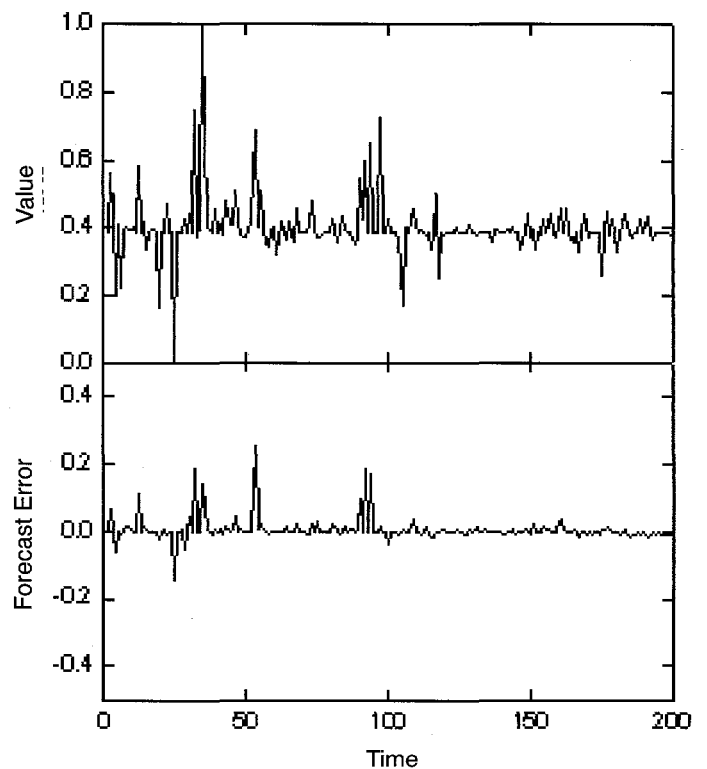

Fig. 40. Value of the inventory difference and the product of forecast errors pertinent to inventory difference and throughput.

The Automated MC&A Database Assessment project is aimed at improving anomaly and error detection in MC&A databases and thereby enhancing compliance, increasing confidence in the data, and gaining a better perspective on overall facility operations. We are working with data from the Los Alamos Plutonium Facility and the Material Accountability and Safeguards System (MASS), its near-real-time computerized nuclear material accountability and safeguards system.

We developed analysis tools to automate the error and anomaly detection process for large databases. As a test-bed we are using MASS, which tracks and records the activities associated with accountable quantities of nuclear material at Los Alamos. Using existing guidelines that describe valid transactions, we created an expert system that identifies transactions that do not conform to the guidelines. Thus this expert system can be used to focus the attention of the expert or inspector directly on significant phenomena.

## Background

MASS is a near-real-time database with terminals located at each site with nuclear material requirements and is the Laboratory's official nuclear material accountability record. It is a dynamic database that tracks and reports the location, use, and status of all the nuclear material items residing at Los Alamos. It enables the management of diverse operations on a variety of nuclear materials. In the history of Los Alamos, this system has evolved from pen and paper journals to the current computerized system.

Models of many of the MASS transactions exist in the form of Process Accounting Flow Diagrams (PAFDs). These flowcharts guide the user when entering a transaction into the MASS database. Because these models of transactions exist, we determined that a rule-based expert system would be the most efficient and effective method of detecting anomalies in the transaction

data. Using the PAFDs allows us to develop rules that apply to items that are being processed.

We built our expert system using commercial expert system development software called Exsys Professional. It distinguishes between valid and invalid transactions. The chief advantage of the expert system is the ease of development and maintenance and the accessibility of the underlying logic. An expert system can provide more information about a transaction than whether it is valid or anomalous. The expert system can evaluate a transaction, indicate how well it matched an allowable transaction, and report which rule(s) have been violated.

## Results

Our expert system analyzed transaction data from March 1994 through April 1995 and generated reports that identified each transaction by a unique ID number and indicated whether it was valid or anomalous. A total of 757 transactions were evaluated; 153 of those transactions were judged to be anomalous. The types of anomalies include the following:

- required field missing,
- invalid field entry,
- procedure violation, and
- a valid transaction that was not defined on the PAFD.

## Future Work

Near-term plans include a regular schedule of analysis of MASS data. From this site-specific anomaly detector, we are extracting features applicable to a generic safeguards anomaly detector and will incorporate them into LANMAS. LANMAS is a new-generation nuclear materials accounting system for DOE sites. LANMAS has been designed to accept site-specific error checking and error handling functions. Inclusion of technology to validate MC&A data will increase the utility of sites' implementation of LANMAS. We hope to help sites develop

anomaly detection systems for their MC&A databases. Advantages of doing so include

- leveraging work already done,
- using local expertise, and
- using the LANMAS connection whenever possible.

Options for site implementation include

- integrating the anomaly detection functions into LANMAS,
- developing the anomaly detector as a stand-alone system, and
- integrating the error detection model into the existing on-site system.

## A Generic Anomaly Detector

After we analyzed results, we evaluated the anomaly detector to determine what features from the facility-specific anomaly detector would be applicable to a generic model, easily adapted to a variety of facilities and MC&A systems. It is our opinion that the expert system is a sound approach to error and anomaly detection in large databases chiefly because most other methods, such as neural networks, require large amounts of clean training data, that is, data free from errors. In the case of MC&A databases, such data would be difficult if not impossible to obtain. In addition, expert systems offer the advantage of the ease of development and maintenance and the accessibility of the underlying logic. Thus, the expert system has the ability to give justification for its classifications. Expert systems can indicate exactly which rules have been violated.

Our experience with PAFDs from the MASS system indicates that using existing guidelines as a basis for an expert system is the most reliable source for encoded expertise. This base must be built upon through interaction with the experts themselves. In most cases this will be an iterative process.

Clearly, developing site-specific anomaly detectors will require work at

the local site. Rules specific to the site must be developed. However, when the database contains MC&A data, there will be many similarities to the MASS data and modifications should be thus minimized. Converting the anomaly detector to other domains entirely, such as financial or transportation data, would require more work.

This work is described in full in Ref. 59. Detailed results are described in full in Ref. 60.

**Data Analysis/Anomaly Detection Software Toolkit for Analysis Research (STAR) (J. Doak, B. Hoffbauer, and J. Prommel, NIS-7).**

### Introduction

The goal of STAR is to produce a research tool that facilitates the development and interchange of algorithms for locating phenomena of interest in large quantities of data. Using this toolkit, researchers will be able to ascertain which existing techniques are the most promising, develop new and possibly more effective methods, and add/delete algorithms without major re-design work. This is a cost-effective method of developing software.

Some modules or components of STAR will preprocess incoming data; some will select the information appropriate for a particular application; some will analyze data to uncover items of significance; and others will assess the effectiveness of the various components. Some of the specific techniques employed by the various modules will be feature selection algorithms, machine learning algorithms, a pure statistical model, and expert system methodologies. Ultimately, STAR will also contain algorithms to perform outcome synthesis: the application of decision theory and risk analysis to conflicting conclusions from the modules.

Ultimately, STAR will also contain algorithms to synthesize the outcomes of concurrent analysis. These algorithms will use decision theory and risk analysis to arbitrate conflicting conclusions from various analysis modules.

All components will be built upon firm theoretical support. We will also define measures by which we can evaluate the effectiveness of the various components, and we will develop software to calculate these measures. Each module will be separately compiled to enable quick-turnaround when changes are made.

During this year, we developed prototype software for two diverse problems at the request of our funders, the National Security Agency (NSA) and DOE/NN-20 Office of Nonproliferation and Arms Control. Note that although the focus of our work has been in these two areas, the methodology used by STAR can be carried over to other problem domains. In fact, we envision customers coming to us with representative data from a particular application and a problem to be solved. Through the use of STAR, we will determine the most effective method(s) of analysis. The customer can then create a production-quality system implementing only those algorithms that we determine to be best.

### Motivation

Huge data storage capacities have made it possible to formulate large integrated databases comprising many terabytes of information spanning a variety of subjects. The ability to analyze such vast quantities of data, which may come from diverse sources, is much sought after. Although the process of accessing the data has become increasingly automated, the laborious task of assimilating, integrating, and interpreting the information still largely remains with a human analyst. With the advent of fast computers, we now have the capability to automate this process, thereby shifting the burden away from the analysts. Unfortunately, the algorithms that instruct computers on how to automatically manipulate such large databases and effectively process their information have not been extensively applied in numerous domains.

There are several reasons why these methodologies have not been widely applied. One is that many of the systems designed to solve problems relating to data analysis are strongly tied to their application. This makes it difficult to re-tool the systems to use alternative approaches preventing a comparison of the effectiveness of various algorithms. Furthermore, much of the analysis research lacks a precise definition of the problem increasing the difficulty of formulating well-defined, coherent goals for which formal solutions can be developed in a structured, incremental fashion. In many cases, this has resulted in a series of ad hoc approaches that—despite solving specific problems—are not well founded in a general theoretical framework. Without such a framework, it is extremely difficult to apply numerous analysis methodologies to a particular problem to determine their relative effectiveness.

Given our goal to develop an analysis toolkit, one might conclude that only algorithms that perform analysis will be developed under this project. However, that is not the case for two reasons. First, no matter what analysis methodology is developed, one needs to have a means of determining objective measures of effectiveness. Algorithms must be defined that calculate these measures of effectiveness. Second, all methods require that an effective set of features be extracted from raw data sources. This will involve algorithms, for example, that cluster the values of features, create new features by combining existing features, and select the most effective features for a given application. Both of these areas pose challenging research problems; STAR will be a platform that allows the research of these algorithms as well.

### Accomplishments of STAR in the Knowledge Fusion Application in 1995

For the Knowledge Fusion Project and NN-20, our emphasis was developing special-purpose software for analysis

of data for the Space and Atmospheric Burst Reporting System (SABRS) project. The primary objective of the SABRS project is to analyze output from particle and radiation detectors on-board satellites to look for clandestine nuclear detonations (nudets). Currently, most of the data analysis and anomaly resolution activities occur only after the detector outputs are received by the ground station. However, much greater on-board processing capability than is currently implemented will be required on future satellites. Downloading of information must be kept to a minimum on these satellites as they will be shared among many applications.<sup>61</sup>

Our role is to provide a software environment in which analysts can develop and optimize computational algorithms required for on-board processing. This environment is being used to test the effectiveness of these methods against simulated data sets, to minimize the false alarm rate, and to determine which of the sensors are the most useful in detecting detonations. In the future, we will work with the designers of on-board systems to develop hardware that can efficiently implement these computational algorithms.

In 1994, the STAR project produced a demo that was designed to show the software that is being used to achieve this goal. The demo was developed to (1) illustrate the software developed by this project, (2) showcase the visual programming environment we used for development, (3) demonstrate why the toolkit approach we adopted has merit, (4) illustrate the challenges and hurdles, and (5) explain our strategy for meeting these challenges in our future work.

The deliverables for 1995 centered around the development of the core STAR functionality. One of the more attractive capabilities of STAR is the ability to integrate new applications into the system with a minimum of design and coding. The STAR design allows new applications to be added by simply writing a few application-dependent routines to get the data into

the system. Once in the system, the data for all applications is represented identically and can be acted upon by any of the data analysis/manipulation routines. We demonstrated this capability by adding a new application, the application for SABRS data analysis, to the system. The experience from this exercise has allowed us to document and streamline the procedure so that future applications can be integrated more efficiently.

The core functionality of STAR is also demonstrated by our development of a means of interprocess communication using shared memory. Our development environment, Khoros 2.0, is well suited to handling disk file transfers of information between processes (separate executables). However, given the large data sets we are tasked to analyze, file input/output is too slow. As a result, we have implemented a method of transferring data by using random access memory. The writing process accesses a chunk of memory identified by a key and writes to it; the reading process uses that same key to "attach" to the memory segment and read from it. No data is ever transferred to disk. In the future, we will continue to explore new methods of interprocess communication, such as object-oriented databases, to use the best technology available. In our demonstration, the process that prepares the information passes it via shared memory to a process that analyzes the data.

Another aspect of STAR is its ability to interface with existing software. Instead of writing new code to accomplish a task, we prefer to utilize available software whenever possible. This was demonstrated by our use of Splus to analyze data that had already been read into the STAR system. We used an Application Programming Interface provided by StatSci to pass data from C++ to Splus, then the data was analyzed via Splus, and finally the results were passed back to C++.

This demo, and the one produced for NSA, were built using the Khoros 2.0 programming environment, a software

integration and development environment that emphasizes information processing and data exploration. The goal of the Khoros software is to provide a complete application development environment that redefines the software engineering process to include all members of the project group, from the application end-user to the infrastructure programmer.

### **Accomplishments in the NSA Audit Analysis Application (1995)**

The problem domain is the analysis of a computer security audit trail. The end goal is to develop machine learning techniques and an expert system that will be used to spot potential computer misuse. This year we concentrated our efforts in the design and development of three modules: (1) Controller, (2) Information Preparation Module, and (3) Module for Building a Methodology and for Analysis. The work done in each module is described below.

#### **Controller**

A prototype Controller module was developed with a graphical user interface to allow the user to specify, for example, the application to be run or the files to be used. The controller is the "owner" of all the data passed between modules through shared memory and communicates the current "state-of-affairs" to each module as it begins execution. Such a mechanism is required because each module runs as a separate process. Without using shared memory, the overhead for the reads and writes for large, complex data sets would be too large to make this a practical approach.

#### **Information Preparation Module**

Phase I of this module covers parsing, rationalization (methods for dealing with missing or erroneous data), value clustering, and abstraction of features (for example, combining features to make them more useful for analysis). For more information on STAR

modules, please read the "Software Toolkit for Analysis Research (STAR)."62,63,64

The data from an audit trail used by NSA consists of many diverse types, including variable-length free text and formatted real numbers. To perform reasonable analysis, input data must be transformed into features containing relevant information. The SVR4++ audit trail data installed on the NIS-7 LAN was examined to determine that more than 50 different transaction types are represented, containing approximately 30 distinct fields. "Sub-classes" of our parsing class were written to parse each of these transaction types, and to create "features" from up to 30 fields in each transaction. Some primitive rationalization was performed including checking for obvious errors in the data (like a date with a month value greater than 12) and for missing data. Values representing "bad-data" or "missing-data" were inserted when necessary (no attempt has been made at this point to substitute a "meaningful" replacement value). We also "clustered" the values of many of the fields so that our analyzer would have statistically meaningful data.

### Building a Methodology and Analyzing Incoming Data

For the build stage, we prepared the data for use by a specific analyzer, in this case, the pure statistical analyzer. This involved selecting features and converting those features that were strings to integers. This conversion was necessary because the pure statistical analyzer works only on integer values at this time. The conversion was done so that the values can be converted back to their string values at the conclusion

of the analysis; the integer values would be of little use to an analyst. A graphical user interface to this module was designed and implemented. During the design of this interface, it was decided that for the pure statistical analyzer, it made sense to combine the "building" and "analyzing" into one module. The module still needs to call the pure statistical analyzer, retrieve the feature data from shared memory, and communicate the results back.

### References

56. L. X. Wang and J. M. Mendel, "Generating fuzzy rules by learning from examples," *IEEE Trans. Systems, Man and Cybernetics*, **22**, 1414-1427 (1992).
57. A. Zardecki, "Analysis of inventory difference using fuzzy controllers," in *Proc. 35th Annual INMM Meeting* (INMM, Chicago, 1994), pp. 304-308.
58. A. Zardecki, "Fuzzy controllers in nuclear material accounting," in *Proc. 1st International Workshop on Fuzzy Logic and Intelligent Technologies in Nuclear Science*, D. Ruan, P. D'hondt, P. Govaerts, and E. E. Kerre, Eds. (World Scientific, Singapore, 1994), pp. 183-187.
59. R. Whiteson, C. Baumgart, L. Spanks, T. Yarbrow, F. Kelso and J. C. Zirkle, "Anomaly Detection Applied to a Materials Control and Accounting Database," Los Alamos National Laboratory document LA-UR 95-2122, presented at the 36th Annual Meeting of the Institute of Nuclear Materials Management.
60. R. Whiteson and C. Baumgart, "Results of Test of Facility Specific Anomaly Detector," Los Alamos National Laboratory document LA-UR-95-3491.
61. Tom Burr, Alton Coulter, Justin Doak, Barbara Hoffbauer, Dave Martinez, Joan Prommel, Clint Scovel, Richard Strittmatter, and Andrew Zardecki, "Knowledge Fusion: Analysis of Vector-Based Time-Series with an Example from the SABRS Project, Final Report," Los Alamos National Laboratory, Safeguards Systems Group report NIS-7/941113 (1994).
62. T. Burr, J. Doak, P. Helman, B. Hoffbauer, J. A. Howell, P. M. Kelly, L. McGavran, R. Pitts, J. M. Prommel, T. R. Thomas, R. B. Strittmatter, and R. Whiteson, "Software Toolkit for Analysis Research (STAR)," Los Alamos National Laboratory report LA-12617-MS (August 1994).
63. J. Doak, J. Prommel, and B. Hoffbauer, "STAR: Software Toolkit for Analysis Research," presented at the 36th Annual Meeting of the Institute of Nuclear Materials Management, Palm Desert, California, July 9-12, 1995; in *Nucl. Mater. Manage.* **XXIV**, 106-1109 (1995).
64. "Software Toolkit for Analysis Research (STAR)," Los Alamos National Laboratory publication LA-LP-94-57 (July 1994).

*Part III.*

*Systems Effectiveness Evaluation*





## PART III. SYSTEMS EFFECTIVENESS EVALUATION

**Shuffler Assay Accuracy: Improvements (P. M. Rinard, NIS-5).** Drums of uranium waste should be disposed of in an economical and environmentally sound manner; the decisions on disposition require the most accurate possible assays of the uranium masses in the drums. The accuracies of assays from a shuffler are affected by the type of matrix material in the drums. Nonhydrogenous matrices have little effect on neutron transport and accuracies are very good. If self-shielding is known to be a minor problem, good accuracies are also obtained with hydrogenous matrices when a polyethylene sleeve is placed around the drums. But for those cases where self-shielding may be a problem, matrices are hydrogenous, and uranium distributions are non-uniform throughout the drums, the accuracies of assays are degraded. The accuracies can be greatly improved by determining the distributions of the uranium and then applying correction factors based on the distributions. A technique for determining uranium distributions by using the neutron count rates in detector banks around the waste drum has been studied and is ready for implementation.

**Technical Summary**

The accuracy of an assay always depends on the closeness of the match between the calibration standards and the drums. This is the most important source of inaccuracy for drums whose matrices have little or no moderating materials (primarily hydrogen). For such drums the distribution of the uranium within the drum does not affect the assay accuracy.

But when the matrix has a hydrogen density of 0.002 g/cm<sup>3</sup> or more, the delayed neutron count rate will change with the uranium's position within the matrix.<sup>65</sup> For matrices such as paper, the effects of the hydrogen are strong enough to cause a 75% error in an assay when the calibration was done for

an average position but the actual uranium was far from the average position. This problem can be eliminated by placing a thin polyethylene moderating sleeve around the drum; the average energy of the neutrons entering the drum is reduced by the sleeve and the gradient of neutron energies throughout the drum is much smaller than without the sleeve. Inaccuracies are cut from 75% to 15% for the worst cases.

But the sleeve could introduce a new cause for inaccuracy: self-shielding. Lower-energy neutrons are less able to penetrate uranium; the surface of the uranium can shield the interior of the drum from the interrogating neutrons and the assay result is proportional to the surface area instead of the mass. If the uranium is in the form of very small particles (about 1 mg or less) that are well dispersed, the self-shielding will not be a problem and the sleeve will still be very beneficial.

But there remains the problem of a drum with a moderating matrix and uranium that can be self-shielding with low-energy neutrons. Without a sleeve we know that the assay value varies with the position of the uranium within a drum containing a moderator. From previous measurements we know how the results vary for a given matrix.<sup>65</sup> So if we can determine the uranium's distribution and estimate the hydrogen density we can correct the count rate for the distribution. Flux monitors in every shuffler have been used for years to correct for some of the effects of hydrogen, so they can again serve as an estimator of hydrogen density.

The analysis technique uses delayed neutron count rates from banks that surround the assay chamber. The typical geometry shown in Fig. 41 has six side banks plus a top and a bottom bank; each bank has six to eight neutron detector tubes whose outputs are normally combined into a single output. The tubes' outputs need not be combined so completely and each bank could give two or three outputs for

more spatial resolution. However, as resolution improves, the count rate per signal channel gets smaller and either counting precision suffers or count times must be lengthened.

The waste drum is divided into many cells of equal volume; such a division is indicated in Fig. 41. The delayed-neutron source strengths in these  $N_S$  cells are  $S_j$ ; in practice, most of these are likely to be zero, but this cannot be assumed. These sources generate  $N_R$  measured count rates  $R_i$  from the  $N_B$  detector banks. The transport function from the cells to the banks has the element  $T_{ij}$ , which gives the count rate in bank  $i$  that is caused by a source mass  $S_j$  in cell  $j$ .

$$R_i = \sum_{j=1}^{N_S} T_{ij} S_j, \quad i = 1, 2, \dots, N_R. \quad (16)$$

This is a set of  $N_R$  equations for the  $N_S$  unknowns  $S_j$ . The transport function  $T_{ij}$  must be established through measurements with standards, as done in Ref. 65. The units of  $R_i$  are counts/s and of  $S_j$  are grams of <sup>235</sup>U, so the units of  $T_{ij}$  are counts/s·g <sup>235</sup>U.

The usual assay adds all the counts from all sources to get an overall count rate,  $R = \sum_i R_i$ , and applies a calibration curve for a homogeneous distribution of the <sup>235</sup>U. This leads to inaccuracies when distributions are not homogeneous.

A unique solution to Eq. (16) for the  $S_j$  is possible only if  $N_R \geq N_S$ . If there are only eight detector banks ( $N_B = 8$ ) it might seem that  $N_R$  can be no larger than eight and each cell must be one-eighth of a drum. But the drum can be measured at different orientations relative to the <sup>252</sup>Cf source to increase  $N_R$ . In fact, different orientations are needed to get an  $R$  equal to the  $R$  in the case of the continuously rotating drum. A set of six counts with the drum rotated 60° between them is equivalent to the more normal case of a continuously rotating drum.<sup>65</sup> The assay result based on  $R$  is then to be corrected from the relative values of  $S_j$  from Eq. (16).

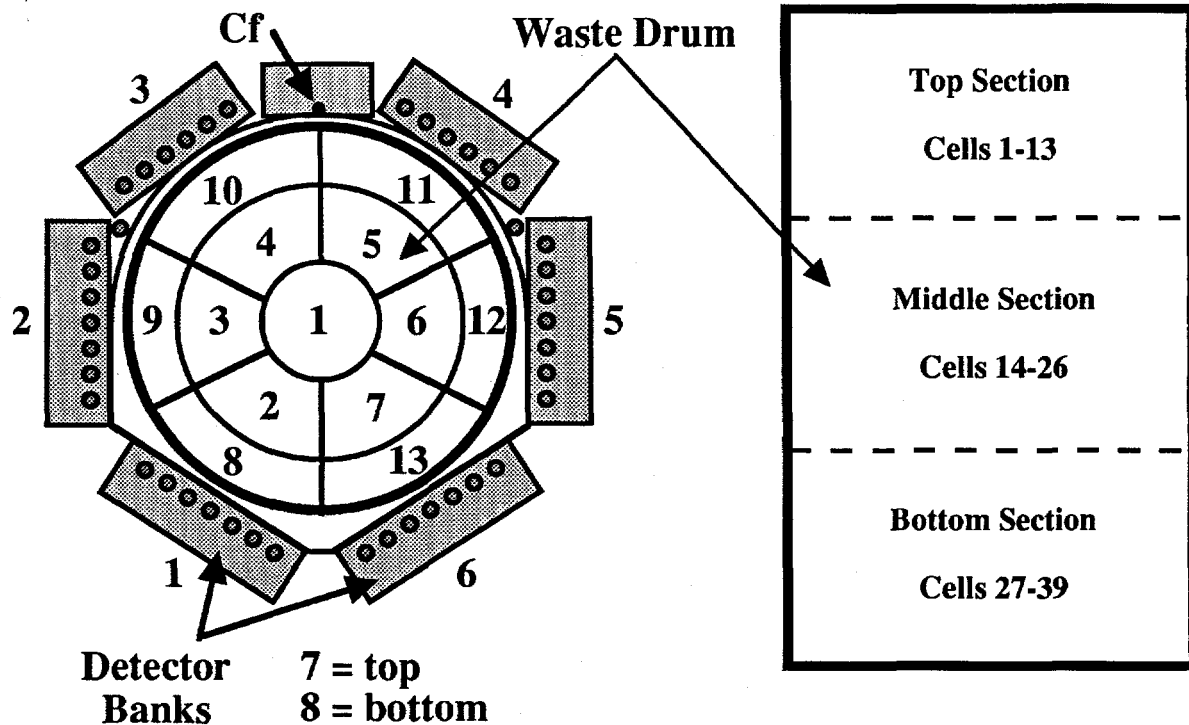

Fig. 41. Two cross sections of a 55-gal. drum are shown. The vertical section on the right has three sections of equal volume. The horizontal cross section on the left is divided into 13 cells of equal volume; the cell labels shown are for the top vertical section. Six lateral detector banks along with top and bottom banks surround the drum to count delayed neutrons. A correction factor for a  $^{235}\text{U}$  position is a function of the vertical section and the radius of the cell in which the  $^{235}\text{U}$  is located; for example, the correction factors for cells 2 and 3 are the same, but those for cells 2 and 8 (or 2 and 21) are different.

Using  $N_O$  orientations increases the number of measurements to  $N_R = N_O N_B \geq N_S$ . The example in Fig. 41 implies  $N_O = 6$  and  $N_B = 8$ , so  $N_S$  can be as large as 48. But this example only has  $N_S = 39$  because the drum is divided in three layers, each with 13 cells, so Eq. (16) is over-determined and solvable. This geometry is a compromise among spatial resolution, count time, and analysis time. More resolution could be obtained with more cells and more orientations, but count and analysis times would have to grow. Any less resolution would not improve assay accuracy enough to be worthwhile.

After testing some ways of solving Eq. (16), the best technique we found is based on the conjugate gradient (CG).<sup>66</sup> The values of  $S_j$  are found that minimize the standard chi-squared function:

$$X^2 = \sum_{i=1}^{N_R} \left[ \left( R_i - \sum_{j=1}^{N_S} T_{ij} S_j \right) / \sigma R_i \right]^2. \quad (17)$$

The solution requires an iterative process and convergence may require a large number of iterations, but with the speed of today's computers and some techniques to accelerate convergence the calculations can be done in a practical manner.

This procedure has been tested on data taken with a paper-filled drum in a shuffler by placing uranium in each of the 39 positions to determine the  $T_{ij}$  and then using the data to find the positions of "unknowns" in the drum. It is clear that statistical fluctuations in the count rates from the detector banks will prevent an accurate value of the waste quantities of uranium (the  $S_j$ ) throughout the drum. But the values of  $S_j$  can indicate the positions of the largest quantities; the results of a conventional

shuffler assay can then be corrected based on these positions.

This technique will soon be implemented on a shuffler and further tested and developed.

## References

65. P. M. Rinard, E. L. Adams, H. O. Menlove, and J. K. Sprinkle, Jr., "The Nondestructive Assay of 55-Gallon Drums Containing Uranium and Transuranic Waste Using Passive-Active Shuffler," Los Alamos National Laboratory report LA-12446-MS (November 1992).
66. William H. Press, Brian P. Flannery, Saul A. Teukolsky, and William T. Vetterling, *Numerical Recipes, The Art of Scientific Computing (FORTRAN Version)* (Cambridge University Press, New York, 1992).

---

*Part IV.*  
*Information Assurance*



## PART IV. INFORMATION ASSURANCE

**Independent Validation and Verification and Tripwire Projects (W. J. Huntman, NIS-9).** The development program for information systems for protection technology for FY95 included the Independent Validation and Verification (IV&V) and the Tripwire projects. The IV&V project also provided support for a major effort to develop new computer security policies for the DOE.

### Independent Validation and Verification

The goals of the IV&V project are to develop and provide to DOE and DOE contractors the methodology to fulfill the IV&V requirements established by DOE orders, coordinate IV&V activities in the DOE, and maintain a technical library of IV&V reports.

During FY93 we developed initial criteria for performing an IV&V. Since the original development, we have conducted several IV&Vs and have identified a number of changes that are needed in the criteria. The personnel involved in the IV&Vs have been experienced individuals with a broad base of security experience and information systems knowledge. During FY95 we continued to use experienced personnel and completed three reviews. These reviews were the Los Alamos Integrated Computing Network (ICN) Test Phase, the DOE Office of Safeguards and Security (OSS) Safeguards and Security Information Management System (SSIMS), and the DOE Nuclear Material Management and Safeguards System (NMMSS).

The Los Alamos ICN Test Phase IV&V completed the IV&V process on the ICN begun in FY94 when we completed the design phase IV&V. The ICN IV&V involved reviewing the implementation and testing of the ICN design developed in FY94. The IV&V team found no issues serious enough to affect accreditation, but the team recommended several changes to the operation and

support of the ICN before final accreditation was granted. The recommendation to place the entire network under stringent configuration management was accepted by the Designated Accrediting Authority in DOE/AL and by the Los Alamos organization responsible for the ICN.

The SSIMS IV&V was a review of the planned electronic transfer of unclassified mailing addresses from the SSIMS system to the DOE personnel system. The SSIMS database contains secret/restricted data, and the IV&V focused on the vulnerabilities of the accidental or deliberate transfer of classified information to the unclassified personnel system. The team did not find any realistic potential for the transfer of classified information to an unclassified system. However, as part of the review, the IV&V team identified several aspects of the system design that were unnecessarily complex and made it more difficult to accredit the system. The IV&V team recommended several changes in the design that would ease the accreditation burden and reduce the costs of implementing and maintaining the system.

The NMMSS IV&V focused on the operational readiness of the NMMSS system. It replaces the Lockheed-Martin NMMSS system that was operated in Oak Ridge, Tennessee. The new NMMSS had encountered a number of difficulties during its implementation due to changing requirements imposed by Lawrence Livermore National Laboratory and a very negative review by the General Accounting Office (GAO). The IV&V team reviewed the security and operational status of the NMMSS in September 1995. The team found that most of the problems and issues identified by LLNL and GAO had been addressed and the remaining issues were on schedule for resolution by the end of 1995. The IV&V team did not find any operational concerns that would prevent NMMSS from becoming

the United State's system of nuclear material accounting.

The IV&V project also supported the development of an integrated protection policy for DOE information systems. The integrated policy will replace the separate computer security orders for unclassified and classified information. The policy development effort included the development of a manual and set of guidelines for all information on DOE and DOE contractor information systems. The development activities involved participating in numerous DOE Process Improvement Team (PIT) meetings where the direction and general content of the policy were defined, leading discussion on the manual and guidelines at three computer security quality panel meetings, and producing 22 different versions of the manual and guidelines.

### Tripwire

The Tripwire project will define and implement a prototype system to warn, in near-real-time, of possible violations of computer security in an information system or network. The overall concept for the Tripwire project is to develop sensors for operating systems and networks that can be analyzed by a central system for indications of computer security violations. The Tripwire FY95 activities included developing the general design of a tripwire system, installing a test bed for developing and testing a tripwire system, and identifying alarms or sensors for a tripwire system.

The overall design of a tripwire system includes a graphical user interface (GUI) oriented to the security officer, definitions of the alarms or sensors, a method of securely transporting the alarms to the central system, techniques for assessing the alarms, and the appropriate response to the alarms. The GUI must be able to display the status of individual and multiple alarms, change the alarm status and reporting parameters, display and modify the



*Part V.*

*International Safeguards*





## PART V. INTERNATIONAL SAFEGUARDS

**Simulation of the Integrated Materials Examination Facility (C. A. Coulter, NIS-7).** The Korean Atomic Energy Research Institute (KAERI) is evaluating the feasibility of the DUPIC process, in which spent fuel from Korean pressurized water reactors (PWR) would be repackaged into fuel assemblies for CANDU reactors. KAERI is developing the Integrated Materials Examination Facility (IMEF) to test the DUPIC process on a pilot scale. Under an agreement between the U.S. DOE and KAERI, the Safeguards Systems Group is working with KAERI personnel to develop an integrated safeguards system for IMEF. As one part of this development, a simulation model of IMEF is being constructed using the Facility Simulation (FacSim) program.

Work began on the IMEF simulation in March 1995. Using information provided to Los Alamos by KAERI, we developed preliminary incomplete IMEF data files for use with FacSim. Additional information was then requested from KAERI and used to continue the development of the IMEF data files. It is expected that one or two more information exchanges between KAERI and Los Alamos will be required to complete the preliminary version of the IMEF simulation model, and this probably can be accomplished by the end of CY95.

**Modification and/or Extension of NRTA Simulation Techniques (C. A. Coulter, NIS-7).** The Safeguards Assay Group and the Safeguards Systems Group entered into a DOE-approved work-for-others contract with Japan Nuclear Fuels, Limited, (JNFL) to continue a study of near-real-time accounting (NRTA) for the Rokkasho-Mura Reprocessing Plant (RRP). The RRP facility comprises two components: the main process area, in which irradiated reactor fuel is processed to produce plutonium nitrate and uranyl nitrate, and the co-denitration facility, in which

the plutonium nitrate and uranyl nitrate are combined and converted to mixed oxide. The NRTA study itself consists of three tasks: Task 4. Modification and/or Extension of NRTA Simulation Techniques; Task 5. Development of Anomaly Detection Methodology; and Task 6. Conceptual Design for NDA Instruments. Work on the simulation of the main process area and the co-denitration facility under Task 4 is described here.

### Main Process Area

From a simulation standpoint, the main process area consists entirely of continuous-flow processes. The simulation is performed by integrating a set of differential equations that describe changes in the contents of process vessels and pipes. Because there are many process vessels and pipes, an efficient integration procedure is needed to perform the simulation in a convenient length of time. The FacSim integration procedure was completely revised to incorporate the following features:

- A graph-theory algorithm is used to decompose the set of process vessels and pipes into "biconnected components" mutually connected by single pipes.
- Each biconnected component is represented by its own system of differential equations. Calculated values for the system that are needed by other biconnected components are saved for a period of time in a system "history."
- A supervisory "flow system" monitors the progress of the individual systems of differential equations and provides coordination between these systems.

As a result of these modifications, integration times for simulation of the RRP main process area have decreased by an order of magnitude.

The description of the evaporator was enhanced and now more accurately describes nuclear material inventories during transient operation such as start-up and clean-out.

The most complex process vessels in the main process area are the pulsed columns, whose operation involves turbulent viscous flows of counter-current acid and organic streams. Currently FacSim uses simple models of these vessels that adequately describe their gross operating features but that cannot provide detailed information about the distribution of materials in the vessels. We have developed a method to calculate the material concentrations at arbitrary points in the vessels at arbitrary times in terms of one-dimensional integrations over the original concentrations and over concentrations in input flows. This method is much simpler than traditional methods for calculating the operating characteristics of pulsed columns and will be used to improve the accuracy of pulsed-column representations in a future version of FacSim.

### Co-Denitration Facility

The co-denitration facility contains both continuous-flow and batch processes. In the initial version of the simulation model for this facility the batch processes were approximated by continuous-flow processes. With the completion of the batch-processing capabilities in FacSim, this model is being revised to describe the batch process operations more accurately. The revised model should be complete in late CY95 or early CY96.

**Simulation of a Representative Reprocessing Plant (C. A. Coulter, NIS-7).** One of the most difficult tasks faced by the IAEA is assuring safeguards at large-scale reprocessing plants, where in-process inventories are not only large but also mostly inaccessible for direct surveillance and measurement. Furthermore, because of the

large throughputs of such a facility, it is impossible to meet the IAEA diversion-detection goals by materials accounting alone. For these reasons there is interest in developing and testing anomaly-detection methods that can be applied to observed operating parameters at reprocessing plants to supplement materials accounting in detecting safeguards anomalies. Because real reprocessing plants cannot be used for developing and testing these anomaly detection methods, a simulation model of a reprocessing plant is being developed that can generate simulated process instrumentation outputs similar to those that would be observed in an operating facility. The purpose of this project is to adapt the simulation program FacSim to generate the desired reprocessing-plant operating-parameter values. Work began on the project in August 1995, so the task is still in its preliminary stages.

The first task was to identify an appropriate reprocessing-plant design for use in the study. Usually reprocessing-plant design features are regarded as proprietary and cannot be used in studies whose results will be generally available. Fortunately, much of the facility design for the Allied General Nuclear Services plant at Barnwell, South Carolina—which was built, but never operated because of changes in U.S. government policies—is available from open sources. It was therefore decided to use the Barnwell design for the study by supplementing the publicly available facility information with “best guesses” for unknown parameters.

In the initial phase of the task, information has been compiled on the Barnwell facility design and used to begin constructing a set of FacSim data files describing the facility and its operation. It has been necessary to resolve a number of issues related both to specific characteristics of the Barnwell design and to incomplete information about the facility, but ways have been found to deal with most of these problems. Construction of the data files is continuing, and it is expected that preliminary

simulation results will be obtained near the end of CY95.

**Safeguards Analysis for Accelerator-Based Conversion (C. A. Coulter, NIS-7).** The President has committed the U.S. to disposing of 200 metric tons of fissile materials previously used in nuclear weapons. A number of options for disposing of this material are being evaluated with respect to both feasibility and safeguards issues. One of the disposition options initially considered was accelerator-based conversion (ABC). In the ABC process the fissile materials to be disposed of are placed in a sub-critical reactor assembly, and the reactor assembly is brought to criticality by supplying additional neutrons generated by nuclear spallation produced in a target by a high-current medium-energy proton beam from a linear accelerator. Heat produced by the reactor is used to generate electricity; over an operating cycle most of the plutonium in the reactor is burned, and the remainder is converted to an isotopic composition that is generally considered very undesirable for use in nuclear weapons.

Our group examined the safeguards issues for the ABC disposition approach. Required protection levels were determined, and radiation safety issues related to americium in-growth and ( $\alpha, n$ ) neutron emissions from certain compounds were enumerated. It was noted that R&D would be required to develop more accurate NDA measurement methods for several of the material forms that would be involved as feeds or waste products of the process.

Safeguards evaluation of the ABC process was discontinued because the ABC approach was dropped from the list of disposition options under active consideration by DOE.

**Global Nuclear Material Monitoring (J. A. Howell, NIS-7; H. O. Menlove, NIS-5; C. Rodriguez, NIS-7; P. Argo, NIS-1; and C. Goulding, NIS-6).** Nuclear weapon components

from dismantlement and excess nuclear materials from weapons activities are or soon will be submitted to bilateral or international inspection as part of programs in arms control confidence building and supporting the nonproliferation regime. Ultimately, the weapons components will be processed to unclassified, storable forms under a program to “irreversibly” remove excess fissile materials from our active weapons materials stockpile. This components processing step will take place in both Russia and the U.S., and may be undertaken in existing facilities or in special purpose transportable processing units as proposed by the Los Alamos Nuclear Materials Program.

The work described here provides a flexible, integrated pilot demonstration of a monitoring approach for nuclear component disassembly and conversion that could be used at fixed sites or in conjunction with the transportable processing concept and operate in a continuous, unattended mode. This demonstration system, when completed, will include aspects of item signature identification, perimeter portal monitoring, advanced data analysis, and communication as a part of an unattended continuous monitoring system in an operating nuclear facility. The end result will be the foundation for a cost-effective monitoring system that could provide the necessary transparency even in areas that are denied to foreign nationals in both the U.S. and Russia should these processes and materials come under full-scope safeguards or bilateral agreements. Monitoring systems of this kind have the potential to provide additional benefits including improved nuclear facility security and safeguards and lower personnel radiation exposures.

This project builds on work of previous years from the VTRAP (Video Time Radiation Analysis Program) project, incorporating three technologies: nondestructive assay, video image processing, and pattern recognition. It provides the basis for

- Pattern recognition,
- Feature extraction,
- Testing of advanced neural network paradigms,
- Validation of normal operations,
- Anomaly detection in a background of normal activity, and
- Identification of proliferant discriminants.

During this year, we developed initial concepts to transform and integrate digital video and radiation sensor data for neural network analysis. We identified video and radiation monitors in a nuclear material laboratory for testing our methodology and collected preliminary data for analysis. Using this preliminary data, we established requirements for frequency of data collection, identified preliminary types of patterns in the data, and developed a simple model of material movement based on this data.

We have developed and tested transformation algorithms for the data that integrate temporal heterogeneous data into a consistent homogeneous data set for neural network analysis. Transformation algorithms have been applied to two-dimensional digital video images (movement) and radiation signals (nuclear material) to provide time-based data for automated analysis on movements of personnel and nuclear materials. This analysis could be extended to evaluate the system's ability to recognize personnel and movement and to identify radiation and provide information on nuclear material types, isotopics, and mass. Continuing developments will allow evaluation and integration of additional sensor systems, such as smart portal monitors that provide signatures, face recognition, and fingerprints in addition to power line monitors that monitor plant operations.

**Global Nuclear Material Flow Model (Jared Dreicer, NIS-7).** The Global Nuclear Material Flow Model project characterizes and models, from a global perspective, the management, control, and flow of weapons-grade nuclear material (plutonium and HEU).

This model provides a computer-based tool capable of

- (1) capturing and enumerating the information and data concerning the global inventory of nuclear weapons material;
- (2) providing a global view of the management and control of nuclear material, including resource and accounting requirements;
- (3) undertaking macro-system simulations of safeguards-accounting surety and safeguards-resource estimation for the management and control of nuclear material;
- (4) visually representing the information related to nuclear materials (e.g., management and control, quantity, location, and transit) and both the inter-country and intra-country nuclear material flow; and
- (5) supporting the development of other pertinent algorithmic capabilities necessary to undertake further global nuclear-material-related studies.

FY95 accomplishments are as follows: (1) partially enumerated the quantity of plutonium that exists globally by country and site; (2) developed a visual representation of the previous characterization from a global perspective; (3) initiated characterization and development of the safeguards management MPC&A, disposition, and proliferation algorithms; and (4) developed a prototype of the fundamental computer-based framework necessary to undertake global nuclear material management studies.

The Global Nuclear Material Control (GNMC) model has been developed on a Sun workstation. There are three fundamental components to the GNMC model: physical process representation, model infrastructure design, and data and contextual information. The physical process representation

component has the primary functional computational capabilities of the GNMC model. There are three functional capability categories related to nuclear materials: proliferation, safeguards and security, and disposition options. There is also a graph-theoretic capability category. The proliferation category permits the investigation and study of fuel cycle production, dismantlement, storage, and inventory depletion issues. The safeguards and security category provides analytical modeling and computational support for studying and analyzing international inspection and protection resources, requirements, and criteria. The disposition-options category provides analytical modeling and computational support for vitrification, geologic-repository, and reactor-related research. The graph-theoretic capability category provides the analytical modeling and computational functionality to conduct various graph-theoretic and network optimization studies, including network (material) flow and shortest or constrained path analysis. This category leverages the underlying graph-theory-based infrastructure design feature.

The model infrastructure has been designed to support investigation across a broad range of detail, specificity, and perspective. There are four aspects to the model infrastructure: the graph-based data framework, the structural hierarchy, the nuclear fuel cycle visual representation, and the geographic illustration. The most fundamental design feature of this model is the graph data framework. All facilities, sites, countries, and categories are represented as vertices, and every connection is represented as either a directed or an undirected edge. The structural hierarchy design decomposes the world into four designations: nuclear weapon states, threshold nuclear weapon states, potential nuclear weapon states, and nuclear states. These designations are further decomposed into their constituent countries. The countries are delineated by all of their respective nuclear sites. A site is determined by

the facilities that exist at the site, as exhibited in Fig. 42. The final feature of the model infrastructure is the geographic illustration (see Fig. 43); this provides an interactive map of the world that includes all of the modeled facilities and sites and some geographic characteristics, such as rivers and lakes.

The last component of the GNMC model is the data and contextual information. The data and information are specific to each level of the hierarchy of the model. The specificity ranges from facility-specific physical process data to more general world information and data. Figure 43 depicts some of the nuclear sites included in the model. Examples of some of the data are geographic location of facilities; type of facility; physical process data; the Non-proliferation Treaty signatory status of a country; and facility, site, country, category, and world fissile material inventory data.

**IAEA Inspector Training Course** (J. E. Stewart, T. D. Reilly, J. L. Sander, C. L. Zerwekh, NIS-5). The 29th session of the IAEA Inspector Training Course was held at Los Alamos from February 7 to 17, 1995. The course went very well, based on all comments received. IAEA participants included twelve inspectors and George Baldwin, from the IAEA Safeguards Training Section, who participated as an instructor.

The participation of the IAEA training specialist was especially valuable because of his current knowledge of

Agency NDA procedures and hardware, which were implemented to the fullest extent possible. A group photo and name key appears as Fig. 44.

The daily schedule of training sessions is shown in Table XV. The IAEA Inspector Training Course stresses "hands-on" measurement exercises with NDA instrumentation that the inspectors routinely use at nuclear facilities worldwide. At Los Alamos, a wide variety and large quantity of well-characterized uranium and plutonium standards are available for training on and calibrating NDA systems.

The objectives of this training course are to

- Reinforce, complement, and extend previous (ICAS) NDA experience and training, including basic principles;
- Increase "hands-on" experience with neutron and gamma-ray NDA instrumentation and IAEA procedures;
- Increase familiarity with calibration and verification for a large amount and wide variety of uranium and plutonium materials;
- Demonstrate, with practical exercises, limitations of NDA methods and procedures;
- Simulate an inventory verification exercise using prior calibrations and unknown samples ("Brings everything together in a realistic way."); and
- Bring together IAEA inspectors with NDA technical experts.

In the February 1995 course, two new IAEA systems were used for plutonium-isotopics analysis, the Medium- and High-Count-Rate Systems (MCRS and HCRS). The latest versions of IAEA procedures and software were used for bulk-mass measurements of plutonium and uranium. These exercises were performed with the High Level Neutron Coincidence Counter (HLNC), the Active Well Coincidence Counter (AWCC) and the Uranium Neutron Coincidence Collar (UNCL).

Also, examples of new technology were demonstrated that enhance inspection efficiency or improve measurement accuracy. These are as follows.

- (1) The new Windows-based neutron coincidence counting (NCC) code that includes built-in calibration and curve-fitting options for HLNC and AWCC measurements;
- (2) Neutron multiplicity counting for plutonium scrap;
- (3) The Miniaturized, Modular MCA ( $M^3CA$ ), for uranium enrichment;
- (4) The Portable Shift Register (PSR); and
- (5) Video-imaging technology.

The 30th session of this course is scheduled for February 6–16, 1996, at Los Alamos. A number of upgrades are planned for this next session, including a new, larger training facility that will reduce costs of access to SNM.

**Active Well Coincidence Counter (AWCC) for Nuclear Material Verification Measurements at the Obninsk IPPE BFS-1 and BFS-2 Facility** (J. Stewart, R. Seibelist, C. Hatcher, M. Krick, K. Kroncke, and H. Menlove, NIS-5). A standard AWCC<sup>67-70</sup> was prepared, modified, and shipped to the Obninsk (Russia) IPPE for verification measurements of uranium and plutonium disks. The AWCC is a versatile instrument that can be used either in active mode to assay  $^{235}\text{U}$  mass in HEU items, or in passive mode to determine  $^{240}\text{Pu}$ -effective mass in plutonium-bearing items.

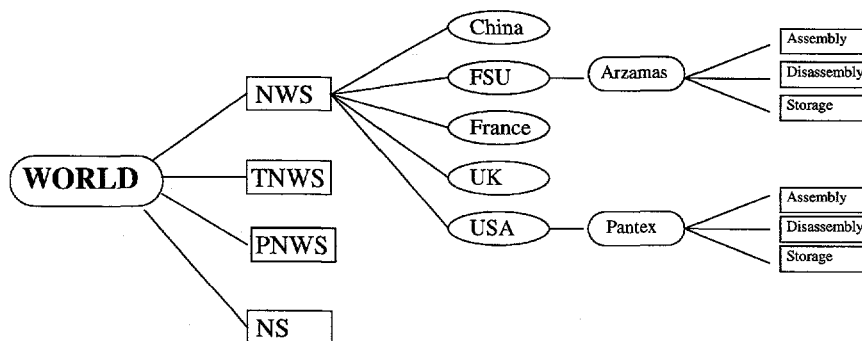
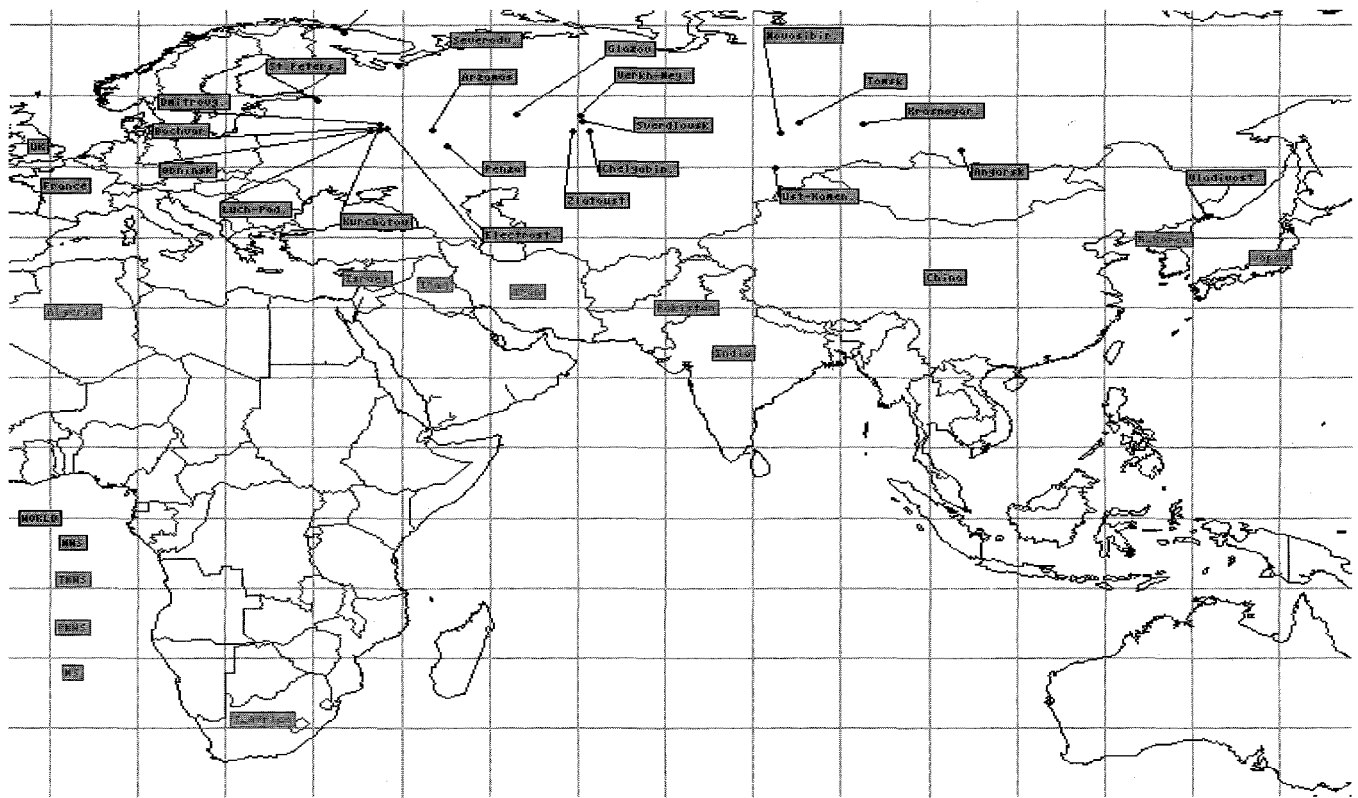

Fig. 42. Global Nuclear Material Control model structural hierarchy.



*Fig. 43. Global Nuclear Material Control model geographic contextual information.*



*Fig. 44. Participants in the Nondestructive Assay Inspector Training Course, held February 7–17, 1995. From left to right (front row): Bob Likes, Tracy Wenz, Carol Zerwekh, Chris Bjork, Shigeo Akiyama, Zhiming Zhou, Yoshiharu Nagaoka, Baftjar Novruzaj, Jacob Hazan, Riley Carver, Jan Sander, Shengli Zhu, and Alexandre Ossipov. From left to right (back row): Jim Stewart, Johannes Slabber, George Baldwin, Alexandre Koudriachov, Merlyn Krick, Brian Rens, Sung-Gi Park, Willie Atencio, Jack Parker, and Dick Siebelist.*

Table XV. Schedule for IAEA Inspector Training (February 1995)\*

Day	Neutron Section				Gamma-Ray Section			
	Exercise	Equipment	Stations	Instructors	Exercise	Equipment	Stations	Instructors
<b>1</b> <b>am</b>	Basic Principles	2-tube detector	3	Baldwin Likes Wenz	Uranium Enrichment	NaI, PMCA	3	Bjork Halbig Sprinkle
(Wed, 8 Feb) <b>pm</b>	Coincidence Counting Principles	HLNC-II, JSR, NCC	"	"	"	"	"	"
<b>2</b> <b>am</b>	PuO <sub>2</sub> Calibration	HLNC-II, JSR,	"	Baldwin Likes Wenz	Uranium Enrichment	HPGe, PMCA	3	Bjork Halbig Sprinkle
(Th, 9 Feb) <b>pm</b>	and Verification	HLNC, NCC  PNMC	"  1	"  Krick	Plutonium Isotopics	HPGe, MCRS, HCRS	3	Parker Reilly Sampson
<b>3</b> <b>am</b>	HEU Calibration and Verification	AWCC, JSR, ANCS, NCC	2	Baldwin Likes	Plutonium Isotopics	HPGe, MCRS, HCRS	3	Parker Reilly Sampson
(Fri, 10 Feb) <b>pm</b>	LEU Fuel Verification	UNCL, JSR, ANCS	1	Menlove Siebelist	"	"	"	"
<b>4</b> <b>am</b>	Basic Principles	2-tube detector	3	Baldwin Likes Wenz	Uranium Enrichment	NaI, PMCA	3	Bjork Halbig Sprinkle
(Mon, 13 Feb) <b>pm</b>	Coincidence Counting Principles	HLNC-II, JSR, NCC	"	"	"	"	"	"
<b>5</b> <b>am</b>	PuO <sub>2</sub> Calibration	HLNC-II, JSR,	"	Baldwin Likes Wenz	Uranium Enrichment	HPGe, PMCA	3	Bjork Halbig Sprinkle
(Tu, 14 Feb) <b>pm</b>	and Verification	HLNC, NCC  PNMC	"  1	"  Krick	Plutonium Isotopics	HPGe, MCRS, HCRS	3	Parker Reilly Sampson
<b>6</b> <b>am</b>	HEU Calibration and Verification	AWCC, JSR, ANCS, NCC	2	Baldwin Likes	Plutonium Isotopics	HPGe, MCRS, HCRS	3	Parker Reilly Sampson
(Wed, 15 Feb) <b>pm</b>	LEU Fuel Verification	UNCL, JSR, ANCS	1	Menlove Siebelist	"	"	"	"
<b>7</b> (Th, 16 Feb)	<b>Inventory Verification Exercise ("Treasure Hunt")</b> <b>Baldwin, Likes, Reilly, Siebelist, Stewart</b>							

\*Abbreviations, such as HLNC and JSR, are spelled out in the Glossary.

## Preparations

For initial work at the Obninsk IPPE, three measurement configurations were provided.

First, the standard AWCC active (with AmLi sources) end plugs were lengthened for thermal (no cadmium) measurements of single HEU metal and oxide disks. A series of laboratory measurements with a small HEU metal disk (20 g of  $^{235}\text{U}$ ) resulted in an optimum cavity height of 10.2 cm (4 in.) with the polyethylene (PE) rings in place. Results of these measurements are shown in Fig. 45. Also, the addition

of small PE disks, 1.3 cm (0.5 in.) thick, covering the AmLi sources, was found to improve measurement precision as well. This configuration is expected to yield a measurement precision of <3% for a sample containing 20 g of  $^{235}\text{U}$  in 1000 s of counting. Using a variety of HEU metal disks and foils available at Los Alamos, a calibration curve was generated. This calibration may be used for initial verification measurements of single disks at Obninsk, but it is recommended that individual calibration curves be generated using facility working standards for each material category. This

recommendation applies to both single- and multiple-disk measurements.

Regarding the second measurement configuration, an aluminum carousel was fabricated with the multiple-disk capacity of a single, full 50-cm storage tube. This carousel is designed to be used in the standard AWCC configuration, without the nickel ring, in fast mode (with cadmium). If the facility MC&A plan allows, this is the much preferred configuration for measurement of HEU disks, from the standpoint of throughput, measurement precision, and accuracy.

AWCC Calibration: Thermal Mode, 4-in. Cavity Height with Doughnuts and 0.5-in.-Thick Poly Disks on AmLi Sources, Centered Samples

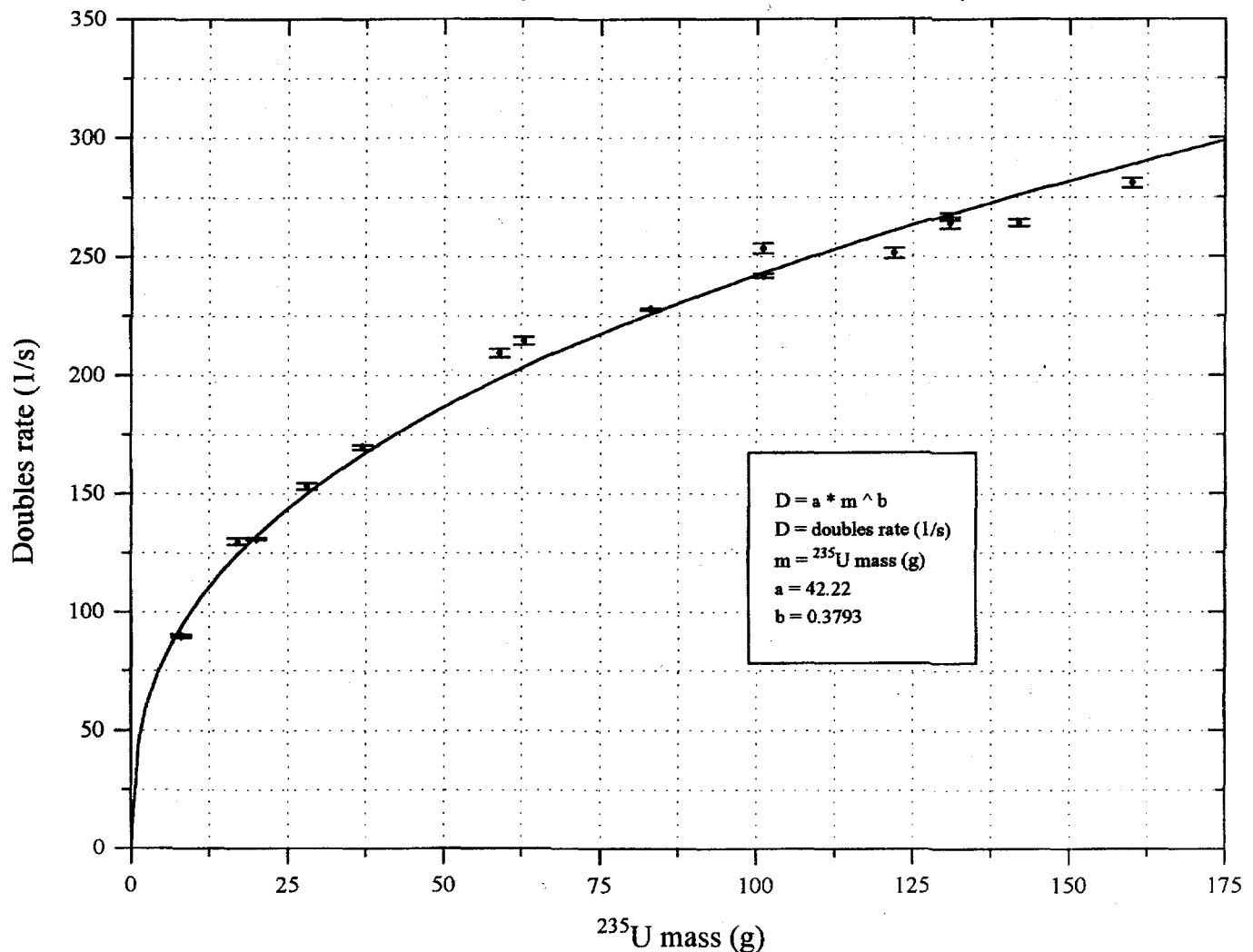

Fig. 45. Results of cavity optimization measurements with the AWCC in thermal mode and using a small HEU disk (20 g of  $^{235}\text{U}$ ).



For the third measurement configuration, special graphite end plugs were fabricated for passive (no AmLi sources), fast mode (with cadmium) measurements of plutonium disks. The measurement cavity will hold single disks or disks stacked in one or more 25-cm storage tubes. This configuration can also be used for passive measurements of depleted uranium and  $UO_2$  as well as  $NpO_2$ .

In summary, for the inventory of disks stored for the BFS-1 and BFS-2 critical assemblies, the AWCC can be used for measurements of the materials and configurations shown in Table XVI.

### Installation

In June, the AWCC was installed at the IPPE. Two of us met with Obninsk physicists Mozhaev, Doulin, and Savlov to discuss underlying principles of neutron coincidence and multiplicity counting as applied to nuclear material verification in general, and to the verification of the inventory of plutonium and uranium disks used at the Obninsk reactor critical facilities: BFS-1 and BFS-2, in particular. This was a useful discussion to establish a common understanding of the sophistication of the techniques and the simplicity of the measurement procedures. During this visit, we also set up and calibrated the AWCC for individual plutonium disks. We also conducted training on instrument configurations, measurement procedures, and software.

**Kazakstan (J. K. Sprinkle, Jr., T. D. Reilly, and J. K. Halbig, NIS-5; E. A. Hakkila, T. L. Burr, B. Erkkila, R. Whiteson, R. H. Ryan, and J. T. Markin, NIS-7).** The U.S. and Kazakstan have signed an umbrella agreement to improve MPC&A at Kazakstani nuclear facilities. Under the purview of this umbrella agreement, an implementing agreement has been in place for DOE assistance to the Ulba State Holding Company since late 1993, and an extensive support program is under way supported through the Nunn-Lugar

Cooperative Threat Reduction Program. The formal agreements for other facilities are being signed; DOE assistance to these facilities is in the planning stages supported by program funds.

Los Alamos staff members supported site surveys at the four nuclear locations declared by the Kazakstani government. We participated in the MC&A teams, who observed the MC&A activities at the facilities and documented what was lacking. In general, the FSU relied on physical protection and control of both people and nuclear material, consequently the largest need for improvement is in the area of material accounting. For example, none of the facilities could provide a complete inventory list for the corresponding survey team. This deficiency would make an IAEA inspection impossible. The infrastructure under the Soviet system no longer exists. All of the countries' facilities are struggling to deal with the lack of money and transportation, the inability to move large quantities of goods, and the lack of services. These concerns sometimes dwarf the lack of an auditable accounting system, but in general the people we meet and work with have surprising enthusiasm and are trying to make changes as best they can under very difficult circumstances.

Los Alamos staff have made several trips to the Ulba State Holding Company in Ust Kamenogorsk and hosted personnel from the Company at a training seminar on NDA measurements at Los Alamos. The trips to Ust Kamenogorsk involved training and review of facility plans and procedures. The training covered how to use U.S.-supplied hardware, such as portable gamma spectroscopy instruments and a modern computer network. This hardware will enable the Company to perform NDA measurements for enrichment and process holdup as well as allow the Company to build a modern automated accounting system. The initial IAEA inventory verification was completed in September; this was the first facility from the FSU to undergo an IAEA PIV.

Preliminary reports indicate the IAEA is very pleased with the progress the facility has made with U.S. DOE assistance. The facility now has a better understanding of what the process is, what the U.S. is recommending, and why the recommendations are being made. However, the second IAEA inspection, after a year, will allow the computation of material unaccounted for (MUF). We predict that the initial MUF will be large, providing additional incentive to the facility and the support programs to make progress with bringing western accounting procedures, measurement control, calibration, and automation to the Company to reduce MUF.

**U.S. Assistance for Russian National MC&A (J. T. Markin, Center for International Security Affairs (CISA); E. A. Hakkila, K. E. Thomas, D. Wilkey, T. Burr, E. Kern, B. Erkkila, NIS-7; and H. A. Smith, NIS-5).** Part of the U.S. nonproliferation effort involves collaborations with members of the nuclear programs in Russia on the subjects of MC&A and the physical protection (PP) of nuclear material. The goal is to improve nuclear material safeguards throughout the former Soviet Union. In September 1993 a government-to-government implementing agreement was signed, which addressed the U.S. assistance to Russia in MC&A, PP, and regulatory questions. The assistance will take the form of U.S. technical support for the enhancement of the MC&A and PP systems at a Russian model facility, with expansions to other facilities possible. Initial efforts focused on non-sensitive nuclear materials (that is, LEU), with possible extension of activity to materials of higher safeguards interest in the future, as U.S.-Russian working relationships grow and tangible results are obtained with efforts on LEU safeguards.

In February of 1994, Los Alamos participated on the first U.S./Russian Technical Working Group (TWG) in Moscow to select the model facilities for the initial assistance under this implementing agreement. The facility selected was the LEU Fuel-Fabrication

Table XVI. AWCC Configurations for Measurement of BFS-1 and BFS-2 Critical Assembly Disks

Material	Measurement Mode	Number of Disks for each Measurement Single (S) or Multiple (M)	Cavity Configuration	Cavity Height (cm/in.)
Pu (89–96% <sup>239</sup> Pu)	Passive (no AmLi), Fast (cadmium)	S or M (cavity holds one or more 25-cm storage tubes)	Graphite end plugs	35.6/14
U (90% <sup>235</sup> U)	Active (2 AmLi), Fast	M (contents of one 50-cm storage tube)	Aluminum carousel disk holder, standard PE end plugs	20.3/8 (with PE rings)
U (90% <sup>235</sup> U)	Active, Thermal (no cadmium)	S	Long PE end plugs with small PE disks covering AmLi sources	10.2/4 (with PE rings)
U (36% <sup>235</sup> U)	Active, Fast	M (contents of one 50-cm storage tube)	Aluminum carousel disk holder, standard PE end plugs	20.3/8 (with PE rings)
U (36% <sup>235</sup> U)	Active, Thermal	S	Long PE end plugs with small PE disks covering AmLi sources	10.2/4 (with PE rings)
UO <sub>2</sub> (36% <sup>235</sup> U)	Active, Fast	M (contents of one 50-cm storage tube)	Aluminum carousel disk holder, standard PE end plugs	20.3/8 (with PE rings)
UO <sub>2</sub> (36% <sup>235</sup> U)	Active, Thermal	S	Long PE end plugs with small PE disks covering AmLi sources	10.2/4 (with PE rings)
UO <sub>2</sub> (depleted)	Passive, Fast	M	Graphite end plugs	35.6/14
NpO <sub>2</sub>	Passive, Fast	M	Graphite end plugs	35.6/14
U (depleted)	Passive, Fast	M	Graphite end plugs	35.6/14

operation at the Elektrostal Machine Building Plant (near Moscow). Los Alamos is taking the lead in MC&A, and Sandia National Laboratory is leading the PP assistance. The U.S. NRC has the responsibility for assistance in developing a regulatory structure for Russian national nuclear safeguards. In FY94, a site survey was completed, and specific MC&A and PP enhancement projects were identified over short-term (6 months), mid-term (9-12 months), and long-term (18-months) schedules. Los Alamos concluded the 1994 fiscal year by hosting six Elektrostal personnel at the Siemens LEU fuel-fabrication facility in Richland, Washington, for one week. During this visit, the Russians received training on U.S. MC&A systems for LEU, accompanied by in-depth tours of the Siemens facility to illustrate those concepts.

In FY95, Los Alamos participation continued on two more U.S./Russian Working Group meetings to assess progress on tasks and plan for future assistance efforts. In December 1994 Los Alamos conducted introductory training on analysis of MC&A data, demonstrated some portable NDA measurement instrumentation, and developed equipment lists for NDA measurement needs at the Elektrostal facility. Work continued with week-long courses at Elektrostal on "Elements of MC&A Systems" and on "Statistics and Measurement Control in Safeguards Systems." For the MC&A course, Los Alamos staff relied heavily on materials developed for the DOE Domestic Safeguards Technology Training Program.

In March 1995, the U.S. and Russians negotiated an expansion of the MC&A and PP enhancement cooperation to five additional Russian facilities. The scope of the cooperation also broadened to include HEU and plutonium-bearing materials as well as a wider variety of facility types (reprocessing, fuel fabrication, research reactors, and critical facilities). In August 1995, U.S. teams visited five Russian sites offered for this expanded cooperation: the HEU fuel fabrication process at Elektrostal,

the RT-1 reprocessing facility at Mayak, MOX and fuel-fabrication facilities at Luch (Podolsk), critical facilities and research reactors at IPPE (Obninsk), and a variety of processes at Dmitrovgrad. At the end of the fiscal year, multi-laboratory teams were formed to carry out the identified work at each of these facilities. Los Alamos is participating in each of these working groups and has the lead in coordinating the expanded work at Elektrostal. Specific site characterizations and MC&A and PP enhancement projects will be carried out in FY96 and FY97.

### Interaction with France

The U.S. DOE-French CEA (Commissariat à l'Énergie Atomique) agreement for cooperation in safeguards technology was begun in 1985. Recent visits of Los Alamos personnel to the Cadarache Center for Nuclear Studies (near Marseilles, France) and visits of Cadarache personnel to Los Alamos were made for these purposes: (a) comparison of spent-fuel burnup codes for personal computers for safeguards and criticality control applications, (b) comparison of techniques for improving the accuracies of neutron-based instruments by low-resolution imaging, and (c) cooperative work on applications of curium measurements for new safeguards applications in reprocessing plants.

A special collaboration was established for the curium measurements in response to a request for support from the IAEA in safeguarding new, large-scale spent fuel reprocessing plants. Los Alamos and Cadarache groups are studying different aspects of this task and share the progress gained.

**Feasibility Study of Plutonium and Uranium Measurement in Input Dissolver Solutions (T. K. Li, NIS-5; and O. Kitagawa, TRP, PNC, Tokai-Mura, Japan).** R&D activities continue on isotope dilution gamma-ray spectrometry (IDGS) for simultaneously determining the concentrations and isotopic compositions for both plutonium

and uranium in highly radioactive spent-fuel dissolver solutions at reprocessing plants. The technique under development includes both sample preparation and analysis methods. Previous experiments<sup>71-73</sup> have demonstrated that the IDGS technique can determine the elemental concentrations and isotopic compositions of plutonium in dissolver solutions. The chemical separation and recovery methods for just plutonium were ion-exchange techniques using anion-exchange resin beads and filter papers. To keep both plutonium and uranium in the sample for simultaneous measurements, we are studying and developing a new sample preparation method. For simultaneous measurements of both plutonium and uranium, the most important issue is to develop a new method to separate uranium and plutonium from fission products and other actinides and then recover both uranium and plutonium. Furthermore, it is equally important to improve the analysis method so that the precision and accuracy of the plutonium analysis remain unaffected while uranium is also recovered from the sample. Of the few separation methods available, we found extraction chromatography<sup>74</sup> to be the best method. The technique uses U/TEVA•Spec resin to separate fission products and recover both uranium and plutonium in the resin from dissolver solutions.

Figure 46 shows the gamma-ray spectra of dissolver solutions from two different sample preparation methods, for a 1-h count time. For easy comparison, we shifted the plot of the top gamma-ray spectrum slightly to the right. The top (dotted) gamma-ray spectrum is from a dissolver solution obtained by using anion-exchange resins, as in the previous experiments. No uranium gamma rays are found in the spectrum. This indicates that no uranium has been recovered by using anion-exchange resins. The bottom (solid) spectrum is the gamma-ray spectrum of another dissolver solution prepared with extraction chromatography using U/TEVA•Spec resins. Clear

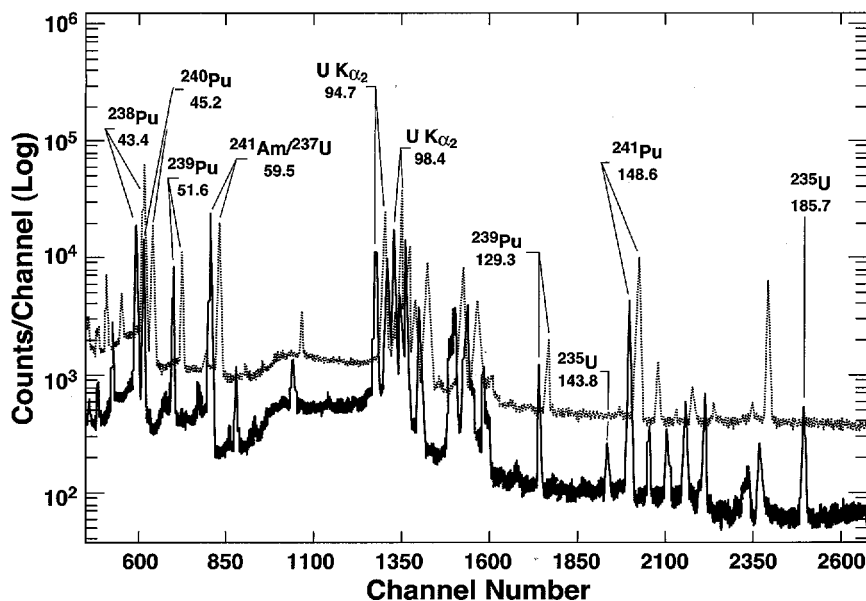

Fig. 46. Gamma-ray spectra of dissolver solutions from two different sample preparation methods for a 1-h count time. For easy comparison, we shifted the plot of the top gamma-ray spectrum slightly. The top (dotted) spectrum is the gamma-ray spectrum from a dissolver solution obtained by using anion-exchange resins, as in the previous experiments. The bottom (solid) spectrum is the gamma-ray spectrum of another dissolver solution prepared with extraction chromatography using U/TEVA-Spec resins.

and intense gamma rays of uranium, e.g., 143.8 keV and 185.7 keV from  $^{235}\text{U}$ , can be identified. The uranium can be recovered with a high yield. Furthermore, the continuum background from high-energy gamma rays from fission products in the bottom spectrum is lower than that in the top spectrum. This indicates that the fission products are removed well with the extraction chromatographic method.

The previous IDGS technique analyzed plutonium only. By developing a new sample preparation method, we can now recover uranium from dissolver solutions. The new sample preparation method rapidly separates fission products and recovers plutonium and uranium from highly radioactive input spent-fuel dissolver solutions through an extraction chromatographic technique. The precision and accuracy of the plutonium analysis are not affected and, even better, uranium is retained in the sample with plutonium. For plutonium isotopic compositions in dissolver

solutions, the bias between IDGS and isotope dilution mass spectrometry (IDMS) is <0.3% for the  $^{240}\text{Pu}/^{239}\text{Pu}$  ratio and <0.01% for  $^{239}\text{Pu}$  (wt%). The precision is ~0.5% for the  $^{240}\text{Pu}/^{239}\text{Pu}$  ratio and <0.2% for  $^{239}\text{Pu}$  (wt%), within a 1-h count time. For plutonium concentrations in dissolver solutions, the bias between IDGS and IDMS is less than 0.15% with a precision of better than 1%, within a 1-h count time.<sup>75</sup>

**Prototype Development of Isotopic Dilution Gamma-ray Spectrometry (T. K. Li and Tom Kelley, NIS-5).** We are developing a prototype IDGS system for simultaneously measuring the plutonium concentration and isotopic composition of highly radioactive spent-fuel dissolver solutions. Because of the small sample volumes (containing less than 0.1 mg of plutonium) in the analysis, the plutonium isotopic ratios  $^{238}\text{Pu}/^{239}\text{Pu}$ ,  $^{240}\text{Pu}/^{239}\text{Pu}$ , and  $^{241}\text{Pu}/^{239}\text{Pu}$  are determined by measuring the high-intensity, low-energy

gamma-ray ratios 43.48 keV/51.63 keV, 45.23 keV/51.63 keV, and 148.6 keV/129.3 keV, respectively.

By measuring the isotopic compositions of both unspiked and spiked dissolver solution samples, the concentration of plutonium in the unknown dissolver solution,  $C_u$ , can be determined as

$$C_u = \frac{M_s}{V_u} \cdot \frac{W_s^9}{W_u^9} \cdot \frac{R_m - R_s}{R_u - R_m} \quad (18)$$

where

- $M_s$  = mass of plutonium in the spike;
- $V_u$  = volume of the unspiked dissolver solution sample;
- $W_s^9$  = weight fraction of the  $^{239}\text{Pu}$  in the spiked sample;
- $W_u^9$  = weight fraction of the  $^{239}\text{Pu}$  in the unspiked sample;
- $R_m$  =  $W_m^0/W_m^9$ , the  $^{240}\text{Pu}/^{239}\text{Pu}$  ratio in the spiked sample;
- $R_s$  =  $W_s^0/W_s^9$ , the  $^{240}\text{Pu}/^{239}\text{Pu}$  ratio in the spike; and
- $R_u$  =  $W_u^0/W_u^9$ , the  $^{240}\text{Pu}/^{239}\text{Pu}$  ratio in the dissolver solution sample.

In this equation, the values of  $M_s$ ,  $R_s$ , and  $W_s$  are known. Therefore, only the values of  $R_u$  and  $W_u^9$  in the unspiked dissolver-solution sample and  $R_m$  in the spiked sample need to be measured by gamma-ray spectrometry.

The prototype IDGS system consists of an HPGe planar detector and associated electronics, an ORTEC Multichannel Buffer (MCB), and an IBM-compatible personal computer (PC). The computer is to interact with the user, to control the MCB hardware to acquire spectral data for measurement information, to automate the analysis of these measurements, and to store gamma-ray spectra on disk for future analysis. A PC at least as advanced as a 486 processor with a clock speed of 33 MHz with 4 MB of memory and a 120-MB hard disk is needed.

The IDGS software package is a Windows application program. The

operating system used on the PC is Microsoft Windows 3.1, which runs on top of DOS 6.3. The Microsoft Visual C/C++ 1.0 compiler, the XVT design tool, the db-VISTA Database Manager, the Ortec DLL (dynamic link library), and the libraries developed by the software section in the Safeguards Science and Technology group are being used as primary development tools. Even though a C++ compiler is being used, the IDGS software is being written in regular C. The XVT design tool is a commercial graphical user interface (GUI) generator. The db-VISTA Database Manager from Raima Corporation is used to store and retrieve the parameters needed for spectral analysis.

The IDGS software became a complete package when a version of FRAM was modified to fit the IDGS requirements and the ability to take live measurements was added. The FRAM analysis algorithms are used to compute peak areas. Special algorithms are used to calculate the relative activities and masses. The measurement option allows the user to automatically analyze a spectrum after a real-time measurement.

The software staff worked closely with the physics staff to determine an appropriate set of values for the analysis parameters based on a typical IDGS gamma-ray spectrum and to determine how the FRAM analysis may be modified to meet analysis requirements for IDGS.

### **Laboratory to Laboratory Materials Protection, Control, and Accounting Program (Mark Mullen and Ron Augustson, CISA).**

#### **Introduction**

In 1994, a program of cooperation was initiated between the U.S. Department of Energy and its laboratories and the nuclear institutes and enterprises of the Russian Federation. The program is to accelerate progress toward a goal shared by both countries: reducing the risk of nuclear weapons proliferation by strengthening systems of nuclear

materials protection, control, and accounting. This program is called the Laboratory-to-Laboratory Nuclear Materials Protection, Control, and Accounting (Lab-to-Lab MPC&A) Program. It is one of several U.S.-Russian cooperative MPC&A programs. It is designed to complement the other programs, such as the government-to-government program of cooperation between DOE and the Russian Ministry of Atomic Energy (MINATOM) and the DOE-GAN (Gosatomnadzor, the Russian nuclear regulatory authority) program of cooperation.

Both countries have repeatedly stressed the importance of these efforts, most recently in the May 1995 summit meeting between President Clinton and President Yeltsin. Their joint statement included the following remarks on MPC&A, which refer in part to the lab-to-lab MPC&A program:

"The two Presidents strongly supported the concrete progress recently made in their two countries' cooperation in ensuring the security of nuclear weapons and nuclear materials that can be used in such weapons. They reiterated their call for broad and expanded cooperation on a bilateral and multilateral basis, consistent with their international obligations, to strengthen national and international regimes of control, accounting, and physical protection of nuclear materials... They directed all relevant agencies and organizations in their respective countries to facilitate in a coordinated manner, effective cooperation to this end."

#### **Background**

An important responsibility shared by the U.S. and Russia, as the world's two largest nuclear powers, is to promote the nonproliferation of nuclear weapons, and, as an integral part of this responsibility, to maintain stringent safeguards on fissile materials that may be used for nuclear explosive devices. With the large-scale arms reductions being carried out by both countries in recent years, this responsibility has

become increasingly important. Large quantities of fissile materials are being removed from nuclear weapons and returned to processing and storage facilities, where they must be subjected to rigorous controls.

Both countries have recognized the importance of strengthening their systems of MPC&A by incorporating the latest scientific and technical advances into the system, and substantial human and financial resources are being applied to this task in both countries.

The Laboratory-to-Laboratory MPC&A Program began in April 1994, when Under Secretary of Energy Charles Curtis, seeking a way to accelerate cooperation and obviate the delays that had hampered other U.S.-Russian MPC&A programs, directed the DOE National Laboratories to extend the highly successful U.S.-Russian lab-to-lab scientific collaborations to include joint work on nuclear MPC&A.

The Laboratory-to-Laboratory MPC&A Program is the culmination of several years of formal and informal contacts on fissile material issues between the U.S. and Russian governments and between U.S. and Russian laboratories and institutes.

Fissile materials can be manufactured or acquired by theft or diversion. MPC&A systems are designed to limit these risks to the lowest possible level, and both countries have had such systems since the 1940s. However, apart from some limited contacts through the IAEA, U.S.-Russian cooperation on MPC&A was almost non-existent until the early 1990s. The lab-to-lab interactions have grown since 1992 to include additional laboratories and institutes and a wide range of scientific activities that have successfully engaged the U.S. and Russian collaborators.

#### **Objective of the Program**

For more than 40 years, since the inception of the Soviet nuclear program in the 1940s, the Soviet Union implemented a highly effective system for

safeguarding nuclear materials. In recent years, fundamental economic, political, and social changes in Russia have prompted a reexamination of that safeguards system. This reexamination, which the Russian Federation began on its own initiative in the early 1990s, has in turn led to a recognition that the MPC&A system must be updated and enhanced to bring it in line with current conditions.

The objective of the lab-to-lab MPC&A program is to enhance, through U.S.-Russian technical cooperation, the effectiveness of nuclear MPC&A in Russian nuclear facilities that process or store highly enriched uranium and plutonium. The enhancements are implemented by the Russian institutes. The U.S. laboratories provide funding for the Russian institutes through laboratory-to-laboratory contracts. They also supply equipment (both U.S. and Russian) and share technical information and experience from U.S. applications of MPC&A methods and technologies.

In pursuing this objective, several key guidelines are followed:

- The lab-to-lab program is intended to complement and reinforce the ongoing Russian federal program for enhancing MPC&A.
  - Both Russian and non-Russian methods and technologies are used, depending on how well they satisfy the technical requirements, including compatibility with Russian conditions (for example, harsh winter weather).
  - Supporting the capacity of Russian industry to develop, produce, and maintain needed MPC&A equipment and systems is an integral part of the program.
  - The focus of the program is on implementation, not research and development, although in some cases MPC&A methods and technologies may require some minor modifications or adaptation to fit Russian conditions and requirements.
- The lab-to-lab program is coordinated with related government-to-government programs, International Science and Technology Center MPC&A projects, and MPC&A cooperation between Russia and other countries such as the European Union, Japan, and the United Kingdom.
  - The need to control and protect sensitive information is recognized.

### Strategy

In developing the strategy for the program, it was necessary to consider two main questions.

- Where is the nuclear material?
- What MPC&A enhancements are needed?

As will be discussed below, the answer to the first question is fairly straightforward, at least in general terms, and information on the location of the nuclear material was used as one of the factors to help determine which institutes and enterprises should be the focus of the lab-to-lab cooperation. The second question is more difficult to address on a generic basis, but for planning purposes, it was concluded that MPC&A requirements can be expressed in terms of certain basic elements—the “building blocks” or basic components of MPC&A. In this section a categorization of the nuclear materials is presented and then the elements of an MPC&A system are outlined.

### The Five Sectors

The weapon-usable nuclear materials in Russia can be partitioned into five categories:

- **In weapons.** These materials are largely in the custody of the Ministry of Defense.
- **In the MINATOM defense complex.** This sector contains very large amounts of material, including the nuclear materials recov-

ered from dismantled nuclear weapons and stockpiles of HEU and plutonium produced for the nuclear weapons program. This sector is a major focus of the lab-to-lab MPC&A program.

- **In the MINATOM civilian sector.** This sector includes a number of reactor development institutes as well as facilities that produce fuels and materials for civilian applications.
- **In civilian applications outside of MINATOM.** A number of research institutes outside of MINATOM possess important quantities of weapon usable nuclear material.
- **In naval propulsion applications.** This sector comprises highly enriched uranium of various enrichments used to power nuclear ships such as submarines and icebreakers.

In planning the lab-to-lab MPC&A program, one goal was to pursue cooperative work in as many of the five sectors as possible. So far, lab-to-lab work has been started in three of the five sectors (the MINATOM defense sector, the MINATOM civilian sector, and the non-MINATOM civilian sector). In each sector, key institutes were identified that could play leading roles in MPC&A work for their sector. The basic premise was that the Russian institutes themselves, not the U.S. laboratories, would be the most effective advocates and implementers of MPC&A enhancements in Russia.

### Elements of An MPC&A System

One of the first issues that must be addressed in planning MPC&A enhancements is to determine the requirements for an effective system. In Russia, the MPC&A requirements are being revamped as part of the process of updating and restructuring the Russian MPC&A system. However, it was not necessary to complete all of the

revisions to the Russian regulatory framework before proceeding with the lab-to-lab MPC&A program. Instead MPC&A requirements were viewed more generically as reflecting certain basic principles, concepts, and approaches that are applicable in any country. Although the details differ to some extent from country to country, certain common approaches are followed world-wide. To be effective, certain required MPC&A elements must be in place, and they must function properly. Although there is no unique, internationally recognized list of elements, most such lists are very similar. Below is one such list, beginning with physical protection elements and continuing with material control and material accounting:

- Detection and assessment (sensors, alarms, and assessment systems such as video)
- Delay (barriers, locks, traps, booths, active measures)
- Response (communications, interruption, neutralization)
- Entry control (badges, biometrics, nuclear material detectors, metal detectors, explosive detectors)
- Communications and display
- Measurements and measurement control (weight, volume, chemical analysis, isotopic analysis, neutron, gamma, calorimetry)
- Item control (bar-codes, seals, material surveillance)
- Records and reports
- Inventory
- Integrated planning, implementation, and effectiveness evaluation
- Supporting functions (personnel, procedures, training, organization, and administration).

The lab-to-lab MPC&A program uses these elements as a guide in planning joint work. For each element, the U.S. and Russian experts jointly consider whether a particular facility requires enhancements and if so, what these enhancements should consist of. Projects are then put into place to carry out the required enhancements. Not all

of the elements are pursued simultaneously at every facility. Generally, several of the elements are selected for the initial stages of cooperation, with the understanding that additional elements can be included later.

### Participants in the Program

On the U.S. side, six laboratories are participating in the program, under the guidance of DOE's Office of Arms Control and Nonproliferation. A Steering Group, including representatives of the six laboratories, oversees the program and makes recommendations to DOE. The six laboratories are

- Los Alamos National Laboratory (lead laboratory, chairs the U.S. Steering Group),
- Brookhaven National Laboratory,
- Lawrence Livermore National Laboratory,
- Oak Ridge National Laboratory,
- Pacific Northwest Laboratory, and
- Sandia National Laboratories.

On the Russian side, there are 11 institutes and enterprises, with more expected to join later. They are listed below. In many cases, several names are in common use for a given institute or enterprise. In the listing below, the most frequently used name is given first, followed by other names in parentheses. No attempt is made here to give a complete account of the mission of each institute or enterprise.

### MINATOM Institutes and Enterprises

- Arzamas-16 (VNIIEF, the All-Russian Scientific Research Institute of Experimental Physics) Nuclear weapons laboratory
- Chelyabinsk-70 (VNIITF, the All-Russian Scientific Research Institute of Technical Physics) Nuclear weapons laboratory
- Automatics (VNIIA, the All-Russian Scientific Research Institute of Automatics) Leading institute for MPC&A instrumentation

- Inorganic Materials (VNIINM, the All Russian Scientific Research Institute of Inorganic Materials, also called the Bochvar Institute after its long-time Director, Academician A. A. Bochvar)
- Eleron. Physical protection component of MINATOM
- Tomsk-7 (Siberian Chemical Complex) Large production complex including reactors, reprocessing, enrichment, and processing of uranium and plutonium
- Four dismantlement facilities (Avangard, Sverdlovsk-45, Zlatoust-36, and Penza-19)
- Institute of Physics and Power Engineering at Obninsk. Reactor technology development.

### Independent Institutes

- Kurchatov Institute (Russian Research Center-Kurchatov Institute) Reactor technology development.

### Progress So Far

The program began in 1994. The goal in the first phase was to demonstrate the effectiveness of the lab-to-lab approach to MPC&A cooperation. Two Russian laboratories were selected for participation in the first phase: Arzamas-16 and Kurchatov Institute. Arzamas-16 was chosen because of its recognized leading role in MPC&A work for the MINATOM nuclear defense complex. Kurchatov was chosen for its advocacy of MPC&A enhancements in Russia and, because it is independent of MINATOM, as a representative of the non-MINATOM sector. Pilot projects were initiated with both of these institutes.

Both pilot projects were completed early in 1995. The Kurchatov upgrades were demonstrated at the end of February to a broad cross-section of Russian ministries and nuclear experts. The Arzamas-16 work was demonstrated to technical experts in January and February and to senior management from

MINATOM and other ministries beginning in March. In April, MINATOM Minister Mikhailov ordered the Arzamas-16 demonstration to be moved to MINATOM headquarters, where additional demonstrations were given in May and June to the managers of the key MINATOM nuclear enterprises and institutes. Both demonstrations received very favorable reactions, not only from the ministries but also from the nuclear facilities, and have greatly strengthened support for expanding lab-to-lab cooperation.

#### Pilot Project With Arzamas-16

The work at Arzamas-16 centered on the demonstration of MPC&A methods and technologies that could be applied at sensitive nuclear facilities in the MINATOM defense complex, especially dismantlement and storage facilities. A combination of U.S. and Russian equipment and methods was used, grouped into five categories: (1) computerized accounting and tracking systems; (2) systems to measure nuclear materials in containers; (3) systems to control access to nuclear facilities (e.g., nuclear material detectors, metal detectors, magnetic badges, and hand geometry readers); (4) systems to monitor containers (bar-codes, seals, video surveillance systems, motion detectors); and (5) equipment to search for and identify lost or stolen nuclear materials. A total of 39 different methods and technologies were included. Because of the sensitivity of the facilities in question, the initial demonstration was carried out in a relatively non-sensitive location at Arzamas-16 using small samples of nuclear materials. As a result of the demonstrations at Arzamas-16 and at MINATOM headquarters, expansion of lab-to-lab cooperation to many additional MINATOM institutes and enterprises is under way. The Russian Multi-Institute Steering Group for the program has been expanded and 13 MINATOM institutes and enterprises have expressed interest in participating in the program: Arzamas-16, Chelyabinsk-70, Tomsk-7,

Mayak, Avangard, Penza, Sverdlovsk-45, Krasnoyarsk, Luch, Automatics, Eleron, Inorganic Materials, and the Institute of Physics and Power Engineering at Obninsk.

#### Pilot Project With Kurchatov Institute

The work at Kurchatov Institute centered on the enhancement of MPC&A for a building at Kurchatov, known as Building 116, which contains two critical assemblies used for civilian reactor physics studies with substantial amounts of highly enriched uranium. Upgrades included a new fence with sensors to detect intrusion; access control features at the entrance to the building (badge readers, metal detectors, barriers, and a guard station); intrusion detection devices and access control features in the areas where nuclear materials are stored; improved lighting; alarm communication and display equipment; and a computerized material accounting system.

As a result of the work at Kurchatov, follow-on work is being planned that will enhance MPC&A for the entire Kurchatov site, including several tons of weapon-usable nuclear material. In addition, an MPC&A initiative with the Russian Navy is being explored, based on the Navy's participation in the Kurchatov demonstration and their subsequent request for similar MPC&A enhancements at naval facilities containing large amounts of highly enriched uranium.

#### Current Work at Obninsk

The work with the Institute of Physics and Power Engineering at Obninsk began in November 1994 with an in-depth planning meeting, followed shortly thereafter by the signing of the first lab-to-lab contracts. The work initially has been focused on the BFS Critical Facility (BFS is the Russian acronym for Fast Physics Assembly). The BFS facility contains two fast critical assemblies known as BFS-1 and BFS-2, each of which are used for fast

reactor physics studies as well as several associated storage areas. Like several similar reactors in other countries that are used for fast reactor studies, BFS-1 and -2 contain very large quantities of fissile materials (several tons of highly enriched uranium and plutonium as well as many tons of low-enriched, natural, and depleted uranium). The materials are in the form of tens of thousands of small disks, clad with metal.

The MPC&A work under way at Obninsk includes

- computerized material control and accounting;
- entry control;
- portal monitoring;
- bar codes, seals, video surveillance systems;
- physical inventories;
- radiation measurements to identify and quantify fissile materials;
- evaluation of the effectiveness of the MPC&A system; and
- physical protection system analyses.

This work will culminate in an integrated demonstration of MPC&A enhancements in August 1995 for U.S. and Russian technical specialists. In September 1995, the enhancements will be demonstrated to officials of MINATOM, DOE, and other U.S. and Russian agencies.

#### Conclusions

In a remarkably short time, the new lab-to-lab MPC&A program has made substantial progress toward its objective of enhancing nuclear MPC&A through U.S.-Russian technical cooperation. The success of the program can be attributed to several factors.

The lab-to-lab program relies primarily on the strong working relationships between the U.S. and Russian technical experts. The specialists on both sides have been able to find a common language through their joint technical work and their mutual scientific interests and training. Administrative and bureaucratic obstacles have been kept to a minimum. The lab-to-lab



program has provided funding to Russian institutes to support at least a part of their efforts. The lab-to-lab program has used both Russian and U.S. equipment. The Russian institutes have been proactive in identifying opportunities, suggesting approaches that are most likely to work well in Russia and "spreading the word" by communicating with their Russian colleagues.

On the basis of the progress demonstrated in the first year, the program is expected to expand in FY96 to \$40 million, and it will continue at that level for the next several years. The emphasis of the program will continue to be on concrete, practical MPC&A enhancements. However, it should be noted that the working relationships that are being established between U.S. and Russian scientists have other benefits beyond MPC&A. While lab-to-lab relationships serve as a starting point for cooperation on broader nuclear security topics such as nonproliferation, transparency, arms control, fissile materials disposition, and others, they can also contribute significantly to U.S.-Russian understanding and to the establishment of truly cooperative, mutually beneficial ties in many technical and non-technical areas.

## References

67. H. O. Menlove, "Description and Operation Manual for the Active Well Coincidence Counter," Los Alamos Scientific Laboratory report LA-7823-M (May 1979).
68. H. O. Menlove and G. E. Bosler, "Application of the Active Well Coincidence Counter (AWCC) to High-Enrichment Uranium Metal," Los Alamos National Laboratory report LA-8621-MS (August 1981).
69. H. O. Menlove and J. E. Stewart, "A New Method of Calibration and Normalization for Neutron Detector Families," Los Alamos National Laboratory report LA-11229-MS (April 1988).
70. M. C. Miller and D. D. Yearwood, "Criticality Study of Various Highly Enriched Uranium Samples Measured in an Active Well Coincidence Counter," Los Alamos National Laboratory report LA-12837 (September 1994).
71. T. K. Li, Y. Kuno, S. Sato, K. Nakatsuka, and T. Akiyama, "Determination of Plutonium Concentration and Isotopic Compositions by Isotope Dilution Gamma-Ray Spectroscopy on Resin Beads," *Nucl. Mater. Manage.* **XIX** (Proc. Issue), 390-396 (1990).
72. T. K. Li, J. L. Parker, Y. Kuno, S. Sato, A. Kurosawa, and T. Akiyama, "Development of Isotope Dilution Gamma-Ray Spectrometry for Plutonium Analysis," in *Proc. 13th ESARDA Symposium on Safeguards and Nucl Mater. Manage.* (ESARDA, Avignon, France, 1991) **24**, pp. 175-185.
73. T. K. Li, Y. Kuno, S. Sato, J. L. Parker, M. Kamata, and T. Akiyama, "Further Development of IDGS—Isotope Dilution Gamma-Ray Spectrometry," *Nucl. Mater. Manage.* **XX** (Proc. Issue), 253-259 (1991).
74. E. P. Horwitz, R. Chiarizia, M. L. Dietz, H. Diamond, and D. M. Nelson, "Separation and preconcentration of actinides from acidic media by extraction chromatography," *Analytica Chimica Acta* **281**, 361-372 (1993).
75. T. K. Li, et al., "Plutonium Analysis in Spent-Fuel Dissolver Solutions by Isotope Dilution Gamma-Ray Spectrometry," presented at the Symposium on Nuclear and Isotopic Methods of Analysis for Safeguards and Security, American Chemical Society, New Orleans, Louisiana, March 24-28, 1996.

*Abstracts and Presentations*

## ABSTRACTS AND PRESENTATIONS

(October 1994 to September 1995)

M. A. Barham, J. K. Sprinkle, Jr., and G. W. Tittlemore, Technical Support and Training for the First Physical Inventory at the Ulba State Holding Company in Ust-Kamenogorsk Kazakhstan, *Nucl. Mater. Manage.* (Proc. Issue) **XXIV** 120-125 (1995).

As part of the United States Department of Energy (DOE) participation in the Cooperative Threat Reduction Program, technical support and training were provided to the Ulba State Holding Company in Ust-Kamenogorsk, Kazakstan, in December 1994, to assist in the completion of the first physical inventory in preparation for the initial declaration of materials to the International Atomic Energy Agency (IAEA). The facility had completed extensive cleanout of process equipment, recovered the uranium, taken composite samples, completed the destructive analysis, and recorded the results in registers. The work to identify individual containers in storage had been completed and the source documents for the uranyl nitrate were located.

Nondestructive assay (NDA) measurements were conducted during the visit of selected items of process equipment, containers of waste materials, and items in storage as part of the process of determining which types of materials would be appropriate to measure routinely by NDA.

The progress made by the facility prior to the arrival of the DOE experts allowed the facility and the DOE Technical Team to discuss the specific reporting requirements for the proposed materials control and accountability system for the site to be implemented as a manual accounting system early in calendar 1995. The use of the manual accounting system will be the basis for the development

of comprehensive user requirements for the planned automated system.

Shirley Bleasdale, Tom Burr, Alton Coulter, Justin Doak, Barbara Hoffbauer, Dave Martinez, Joan Prommel, Clint Scovel, Richard Strittmatter, Timothy Thomas, and Andrew Zardecki, "Knowledge Fusion: Analysis of Vector-Based Time Series with an Example from the SABRS Project," Los Alamos National Laboratory report LA-12931-MS (April 1995).

This report describes work during FY94 that was sponsored by the Department of Energy, Office of Nonproliferation and National Security, Knowledge Fusion project. The project team selected satellite sensor data to use as the one main example to which its analysis algorithms would be applied. Although much of the discussion involves this specific example problem, the goal was to solve the problem in a way that generalizes to other reasonably similar problem domains. The general problem domain is to detect a signal amidst a possibly noisy and non-stationary background using multiple sensors. The data therefore form a vector-valued time series, for which both traditional and modern methods might be applicable.

Tom L. Burr, Lawrence E. Wangen, and Mark F. Mullen, "Authentication of Reprocessing Plant Safeguards Data through Correlation Analysis," Los Alamos National Laboratory report LA-12923-MS (April 1995).

This report investigates the feasibility and benefits of two new approaches to the analysis of safeguards data from reprocessing plants. Both approaches involve some level of plant modeling. All models involve some form of mass balance, either applied in the usual way that leads to

material balances for individual process vessels at discrete times or applied by accounting for pipe flow rates that leads to material balances for individual process vessels at continuous times. In the first case, material balances are computed after each tank-to-tank transfer. In the second case, material balances can be computed at any desired time. The two approaches can be described as follows. The first approach considers the application of a new multivariate sequential test. The test statistic is a scalar, but the monitored residual is a vector. The second approach considers the application of recent nonlinear time series methods for the purpose of empirically building a model for the expected magnitude of a material balance or other scalar variable. Although the report restricts attention to monitoring scalar time series, the methodology can be extended to vector time series.

Tom Burr, Alton Coulter, Justin Doak, Barbara Hoffbauer, Dave Martinez, and Joan Prommel, "Demonstration of the Software Toolkit for Analysis Research," Los Alamos National Laboratory report LA-12924-MS (March 1995).

This report presents an overview of and demonstration guidelines for software developed by the Knowledge Fusion Technologies Project for the Space and Atmospheric Burst Reporting System (SABRS). Data from satellites was enhanced to contain evidence of nuclear detonations (nudets). The resulting data was analyzed using various techniques to determine which algorithms were the most effective at detecting nudets; these algorithms will eventually be implemented in hardware to allow processing on board future Global Positioning System satellites. We wanted to not

only solve specific problems from within this domain but also to solve them in a computational environment that would permit ready application of the tools developed to new domains or different problems in the same domain.

The software platform allowing the algorithmic comparison is known as the Software Toolkit for Analysis Research (STAR). The goal of the STAR project is to produce a research tool that facilitates the development and interchange of algorithms for locating phenomena of interest in large quantities of data. STAR will solve specific problems so that the results will be as generally applicable as possible to new problem domains as they develop. This goal requires the development of a computational environment that will ensure that all tools written for parsing, filtering, analyzing, and displaying, for example, can be used within a unified environment that encourages easy application to new situations. We feel that many non-proliferation projects will eventually benefit from STAR as a uniform method of collection, storage, and analysis of multi-source data is integrated into the system.

Tom Burr, Alton Coulter, Arnie Hakki-la, H. Ai, K. Fujimaki, and I. Kadokura, "Statistical Methods for Detecting Diversion of Materials Using Near-Real-Time Accounting Data," presented at the 36th Annual Meeting of the Institute of Nuclear Materials Management, Palm Desert, California, July 9-12, 1995; in *Nucl. Mater. Manage.* **XXIV**, 1032-1037 (1995).

We selected eight sequential statistical tests and studied their performance on near-real-time-accounting (NRTA) data that is nominally what is expected from the proposed Rokkasho Reprocessing Plant in Japan. The effort divided into three main activities: (1) use process-flow information to determine process

vessel inventories and transfers at the time of material balance closure, (2) use variance propagation methods to estimate the variance-covariance matrix of a sequence of material balances, and (3) study the performance of eight sequential tests on a variety of loss scenarios. This paper describes the results of these three activities.

K. Chitumbo, C. R. Hatcher, S. P. Kadner, and R. Olsen, "Automatic Identification of NDA Measured Items: Use of E-Tags," *Nucl. Mater. Manage.* (Proc. Issue) **XXIV** 663-666 (1995).

This paper describes how electronic identification devices or E-tags could reduce the time spent by IAEA inspectors making nondestructive assay (NDA) measurements. As one example, the use of E-tags with a high-level neutron coincidence counter (HLNC) is discussed in detail. Sections of the paper include inspection procedures, system description, software, and future plans. Mounting of E-tags, modifications to the HLNC, and the use of tamper indicating devices are also discussed. The technology appears to have wide application to different types of nuclear facilities and inspections and could significantly change NDA inspection procedures.

Joe Claborn and Bruce Erkkila, "Computerized Material Accounting," presented at the 17th ESARDA Annual Symposium on Safeguards and Nuclear Material Management, Aachen, Germany, May 9-11, 1995.

With the advent of fast, reliable database servers running on inexpensive networked personal computers, it is possible to create material accountability systems that are easy to learn, easy to use, and cost effective to implement. Maintaining the material data in a relational database allows data to be viewed in ways that were previously very difficult. This paper describes a software and hardware

platform for the implementation of such an accountability system.

Joe Claborn, "LANMAS Core: Update and Current Directions presented at the 36th Annual Meeting of the Institute of Nuclear Materials Management, Palm Desert, California, July 9-12, 1995; in *Nucl. Mater. Manage.* **XXIV**, 910-913 (1995).

Local Area Network Material Accountability System (LANMAS) core software provides the framework of a material accountability system. It tracks the movement of material throughout a site and generates the required material accountability reports. LANMAS is a network-based nuclear material accountability system that runs in a client/server mode. The database of material type and location resides on the server, while the user interface runs on the client. The user interface accesses the data stored on the server via a network. The LANMAS core can be used as the foundation for building required materials control and accountability (MCA) functionality at any site requiring a new MCA system. An individual site will build on the LANMAS core by supplying site-specific software. This paper will provide an update on the current LANMAS development activities and discuss the current direction of the LANMAS project.

Donald A. Close, Bryan L. Fearey, Jack T. Markin, Debra A. Rutherford, Ruth A. Duggan, Calvin D. Jaeger, Dennis L. Mangan, Ronald W. Moya, Lonnie R. Moore, and Robert S. Strait, "Proliferation Resistance Criteria for Fissile Material Disposition," Los Alamos National Laboratory report LA-12935-MS (April 1995).

The 1994 National Academy of Sciences study "Management and Disposition of Excess Weapons Plutonium" defined options for reducing the national and international proliferation risks of materials

declared excess to the nuclear weapons program. This report proposes criteria for assessing the proliferation resistance of these options. The criteria are general, encompassing all stages of the disposition process from storage through intermediate processing to final disposition including the facilities, processing technologies and materials, the level of safeguards for these materials, and the national/subnational threat to the materials.

Alton Coulter, Tom Burr, Arnie Hakkila, H. Ai, K. Fujimaki, and I. Kadokura, "Estimating Reprocessing Plant In-Process Inventories by Simulation," presented at the 36th Annual Meeting of the Institute of Nuclear Materials Management, Palm Desert, California, July 9-12, 1995; in *Nucl. Mater. Manage.* **XXIV**, 738-743 (1995).

The Safeguards Systems Group's generic simulation program FacSim was used to model the operation of the proposed Rokkasho Reprocessing Plant during an operating cycle consisting of a start-up phase, a period of steady-state operation, and a flush-out phase. The simulation results give a detailed account of nuclear material inventories in various process vessels as a function of time. As expected, it is found that the pulsed columns and the concentrator determine the rate at which the system responds to feed variations and transients; but the in-process inventory is dominated by the contents of the concentrator and tanks, and particularly by the contents of the tanks downstream from the concentrator. The results of the simulation were used for statistical studies of diversion detection, as described elsewhere in these *Proceedings*.

W. J. Desmond, A. F. Czajkowski, N. R. Zack, H. R. Martin, B. Gardner, S. Schlegel, and F. Von Hippel, "United States-Russia Exchange Visits," presented at the 36th Annual Meeting of

the Institute of Nuclear Materials Management, Palm Desert, California, July 9-12, 1995; in *Nucl. Mater. Manage.* **XXIV**, 303-308 (1995).

The Department of Energy, under a government-to-government program, hosted the first visit with the Russian Federation to exchange information and technologies for special nuclear material control, accounting, and physical protection at a plutonium storage facility. The Russian specialists toured a storage facility at the Hanford Site near Richland, Washington, and were shown the physical protection and materials control systems that DOE employs to protect excess nuclear materials. Technical discussions included topics associated with protective forces and their operation, perimeter and interior intrusion detection and assessment equipment/systems, vulnerability assessment demonstrations, and the vault monitoring and materials control systems. In October, the Russian Federation hosted a reciprocal visit to the Mayak Enterprise civil plutonium storage facility, previously known as Chelyabinsk-65. The U.S. specialists participated in technical discussions on the protection and control of plutonium and supported an evaluation of safeguards and security at the Mayak storage facility. The U.S. specialists suggested equipment that could be used to enhance the protection of nuclear materials at Mayak. A follow-up visit to the Mayak Enterprise was to be conducted in February to complete the equipment demonstration and to hold further technical discussions concerning the prevention of the theft or diversion of nuclear materials. This visit has been postponed even though the demonstration equipment was delivered to the Mayak Production Enterprise in April. This presentation will discuss the exchange visits and related safeguards and security equipment demonstrations.

Justin Doak, Joan Prommel, and Barbara Hoffbauer, "STAR: Software Toolkit for Analysis Research," presented at the 36th Annual Meeting of the Institute of Nuclear Materials Management, Palm Desert, California, July 9-12, 1995; in *Nucl. Mater. Manage.* **XXIV**, 106-1109 (1995).

This paper provides an update on the development of the Software Toolkit for Analysis Research (STAR). The goal of the STAR project is to produce a research tool that facilitates the development and interchange of algorithms for locating phenomena of interest in large quantities of data. This goal requires the development of a computational environment that will insure that all tools written for parsing, filtering, analyzing, and displaying, for example, can be easily applied to new situations. We feel that many nonproliferation projects will eventually benefit from STAR, as a uniform method of collection, storage, and analysis of multi-source data is integrated into the system.

We have applied this technology to the Space and Atmospheric Burst Reporting System (SABRS) in support of the Knowledge Fusion Technologies project. Data from satellites was enhanced to contain evidence of nuclear detonations (nudets). The resulting data was analyzed to determine which algorithms were the most effective at detecting nudets; these algorithms will eventually be implemented in hardware to allow processing on board future Global Positioning System satellites. We wanted to not only solve specific problems from within this domain (specifically one involving setting decision thresholds based on the analysis of data streams generated by several different sensors) but also to solve them in a computational environment that would permit the developed tools to be applied to new domains or different problems in the same domain.

This paper will present an overview of the software developed for this knowledge fusion project. We will also present the results of applying the software to the enhanced satellite data.

Justin Doak and Jo Ann Howell, "Guidelines for the Implementation of an Open Source Information System," Los Alamos National Laboratory report LA-12998-MS (August 1995).

This work was initially performed for the International Atomic Energy Agency (IAEA) to help with the Open Source Task of the 93+2 Initiative; however, the information should be of interest of anyone working with open sources. We cover all aspects of an open source information system (OSIS) including, for example, identifying relevant sources, understanding copyright issues, and making information available to analysts. We foresee this document as a reference point that implementors of a system could augment for their particular needs.

The primary organization of this document focuses on specific aspects, or components, of an OSIS; we describe each component and often make specific recommendations for its implementation. This document also contains a section discussing the process of collecting open source data and a section containing miscellaneous information. The appendix contains a listing of various providers, producers, and databases that we have come across in our research.

Jared S. Dreicer, "Global Nuclear Material Flow Model: A Foundation for Nuclear Smuggling Systems Analysis," submitted for publication in the Arms Control and Nonproliferation Technologies Review ACNT Newsletter, Lawrence Livermore National Laboratory (October 1995).

N. Ensslin, M. S. Krick, and H. O. Menlove, "Expected Precision of Neutron Multiplicity Measurements of Waste Drums," *Nucl. Mater. Manage.* (Proc. Issue) **XXIV** 1117-1124 (1995).

DOE facilities are beginning to apply passive neutron multiplicity counting techniques to the assay of plutonium scrap and residues. There is also considerable interest in applying this new measurement technique to 208-liter waste drums. The additional information available from multiplicity counting could flag the presence of shielding materials or improve assay accuracy by correcting for matrix effects such as (a,n) induced fission or detector efficiency variations. The potential for multiplicity analysis of waste drums, and the importance of better detector design, can be estimated by calculating the expected assay precision using a Figure of Merit code for assay variance. This paper reports results obtained as a function of waste drum content and detector characteristics. We find that multiplicity analysis of waste drums is feasible if a high-efficiency neutron counter is used. However, results are significantly poorer if the multiplicity analysis must be used to solve for detection efficiency.

Bruce H. Erkkila and Joe Claborn, "Modernizing Computerized Nuclear Material Accounting Systems," presented at the 36th Annual Meeting of the Institute of Nuclear Materials Management, Palm Desert, California, July 9-12, 1995; in *Nucl. Mater. Manage.* **XXIV**, 890-893 (1995).

DOE Orders and draft orders for nuclear material control and accountability address a complete material control and accountability (MC&A) program for all DOE contractors processing, using, or storing nuclear materials. A critical element of an MC&A program is the accounting system used to track and record all inventories of nuclear material and

movements of materials in those inventories. Most DOE facilities use computerized accounting systems to facilitate the task of accounting for all their inventory of nuclear materials. Many facilities still use a mixture of a manual paper system with a computerized system. Also, facilities may use multiple systems to support information needed for MC&A. For real-time accounting it is desirable to implement a single integrated data base management system for a variety of users. In addition to accountability needs, waste management, material management, and production operations must be supported. Information in these systems can also support criticality safety and other safety issues. Modern networked microcomputers provide extensive processing and reporting capabilities that single mainframe computer systems struggle with. This paper describes an approach being developed at Los Alamos to address these problems.

Bruce Erkkila, "Safeguarding Nuclear Materials in the Former Soviet Union," presented at the 5th International Conference on Facility Operations-Safeguards Interface, Jackson Hole, Wyoming, September 24-29, 1995.

With the restructuring of the former Soviet Union (FSU) into independent states the safeguarding of nuclear materials in the possession of those states has received international attention.<sup>1</sup> Many countries including the United States have expressed interest in understanding the status of these materials and the standards for safeguards being applied to these materials. Many different groups from different countries have been invited to visit and discuss safeguards issues with former FSU countries in the past few years. There is much interest on the part of the FSU to learn how the rest of the world addresses these issues. There is also an opportunity to influence the future

application of international safeguards standards to these materials in the FSU countries.

Bryan L. Fearey, "Environmental Sampling: Issues for the Cut-Off Regime," presented at the Fissile Material Cut-Off Treaty Non-Routine Inspection Workshop," Washington, DC, August 29, 1995; Los Alamos National Laboratory document LA-UR-95-3095.

The fissile material cut-off treaty (FMCT) initiative under the Conference on Disarmament mandate is envisioned to include certain aspects of environmental sampling and monitoring. One of the intents of this treaty is to bring certain non-NPT signatories (e.g., threshold states) under this treaty agreement along with the nuclear weapon states (NSWs). Because this treaty includes NWSs that have had a significant history of weapons-grade materials production, background problems must be considered. Similar problems may come into play for some non-nuclear weapon state (NNWSs) non-NPT signatories.

This paper provides a brief overview of some of the relevant issues that may be involved in the implementation and use of environmental monitoring for (1) verification of the cut-off regime declarations, (2) the detection of undeclared activities, and (3) application of non-routine inspections. The intent is to provide backstopping information important for treaty negotiators.

Specific issues addressed within this paper include signature sampling, differences in the proposed detection regime, potential signature integrators, specific examples and spoofing concerns. Many of these issues must be carefully considered and weighed to create a credibly verifiable inspection regime. Importantly, the cut-off treaty must enable nondiscriminatory implementation, while carefully assuring that nonproliferation treaty

requirements are maintained (i.e., preventing unintentional release of critical weapons design information—potentially through environmental sampling and analysis).

Bryan L. Fearey, "ARIES (Automated Recovery and Integrated Extraction System): Pit Disassembly & Safeguards Transparency Issues," presented at The Fifth International Conference on Facility Operations—Safeguards Interface, Jackson Hole, Wyoming, September 24–29, 1995.

This paper presents a discussion of domestic and international safeguards issues and concerns for the pit disassembly process. The recent impacts of various policy decisions related to excess fissile material on the Fissile Material Disposition Program are examined. Details of specific concerns include transparency issues related to classified materials or components under possible IAEA inspection. In conclusion, a brief outline of some potential transparency implementation options is described.

E. A. Hakkila, "The LASCAR Project," Los Alamos National Laboratory, Safeguards Systems Group report NIS-7/95-801 (July 1995).

No abstract.

J. A. Howell, H. O. Menlove, C. A. Rodriguez, D. Beddingfield, and A. Vasil, "Analysis of Integrated Video and Radiation Data," presented at the 36th Annual Meeting of the Institute of Nuclear Materials Management, Palm Desert, California, July 9–12, 1995; in *Nucl. Mater. Manage.* XXIV, 162–167 (1995).

We have developed prototype software for a facility-monitoring application that will detect anomalous activity in a nuclear facility. The software, which forms the basis of a simple model, automatically reviews and analyzes integrated safeguards data from continuous unattended

monitoring systems. This technology, based on pattern recognition by neural networks, provides significant capability to analyze complex data and has the ability to learn and adapt to changing situations. It is well suited for large automated facilities, reactors, spent-fuel storage facilities, reprocessing plants, and nuclear material storage vaults.

J. A. Howell and W. J. Whitty, "Advanced Integrated Safeguards Using Front-End-Triggering Devices," Los Alamos National Laboratory report LA-13045-MS (ISPO-382) (December 1995).

This report addresses potential uses of front-end-triggering devices for enhanced safeguards. Such systems incorporate video surveillance as well as radiation and other sensors. Also covered in the report are integration issues and analysis techniques.

F. Hsue, J. R. Hurd, P. M. Rinard, "Operating New 55-Gallon Drum Shufflers at Los Alamos," Fifth International Conference on Facility Operations—Safeguards Interface, September 24–29, 1995 (Full Paper—LA-UR-95-3103).

Two passive-active shufflers for the assay of uranium and plutonium have begun operation at Los Alamos National Laboratory. An extensive period of safety and technology assessments were made to meet Laboratory and DOE certification requirements. Many design features of the shufflers are in place to assist the operator in using the instruments efficiently, effectively, and safely. A calibration for uranium oxide has been completed and applied to a variety of uranium-bearing inventory materials. A new calibration for MOX materials is nearly complete and additional uranium and plutonium materials will be measured in the near future.

S.-T. Hsue, H. O. Menlove, and P. M. Rinard, "Design of a New Portable Fork Detector for Research Reactor Spent Fuel," Los Alamos National Laboratory report LA-12892-MS (February 1995).

This report describes the conceptual design of a new fork detector to verify spent research-reactor fuel. The detector can be used to determine the fissile content of Material Testing Reactor spent fuel or the plutonium content of spent MAGNOX fuel. The detector determines the burnup by means of neutron counting, the gross gamma radiation, and medium-resolution spectroscopy from a room-temperature detector.

S.-T. Hsue and M. L. Collins, "New Analysis Technique for K-Edge Densitometry Spectra," Fifth International Conference on Facility Operations—Safeguards Interface, September 24–29, 1995 (Full Paper—LA-UR-95-3222).

A method for simulating absorption edge densitometry has been developed. This program enables one to simulate spectra containing any combination of special nuclear materials (SNM) in solution. The method has been validated with an analysis method using a single SNM in solution or a combination of two types of SNM separated by a Z of 2. A new analysis technique for mixed solutions has been developed. This new technique has broader applications and eliminates the need for bias correction.

Sin-Tao Hsue and Michael Collins "Simulation of Absorption Edge Densitometry," Los Alamos National Laboratory report LA-12874-MS (November 1994).

A method for simulating absorption edge densitometry has been developed. This program enables one to simulate spectra containing any combination of special nuclear materials (SNM) in solution. The method has been validated with an

analysis method using a single special nuclear material in solution or a combination of two types of SNM separated by a Z of 2. This computer simulation has been used to explore the bias caused by the presence of, for example, plutonium in a determination of uranium concentration. We have also used this program to explore better methods of analyzing densitometry data.

J. R. Hurd, F. Hsue, and P. M. Rinard, In-Plant Experience with Passive-Active Shufflers at Los Alamos, *Nucl. Mater. Manage.* (Proc. Issue) **XXIV** 539–544 (1995).

Two Canberra-built passive-active  $^{252}\text{Cf}$  shufflers of Los Alamos hardware and software design have been installed at Los Alamos National Laboratory, one at the Chemistry and Metallurgy Research (CMR) Facility at TA-3 and the other at the Plutonium Facility (PF-4) at TA-55. These instruments fulfill important safeguards and accountability measurement requirements for special nuclear material (SNM) in matrices too dense or otherwise not appropriate for typical gamma-ray or other neutron counting techniques. They support many programmatic requirements including measurements of transuranic (TRU) waste and inventory verification. This paper describes the instrument performance under plant conditions with various background radiations on well-characterized standards to determine long-term stability and establish a calibration. Results are also reported on verification measurements of previously unmeasured inventory items in various matrices and geometric distributions. Preliminary investigative measurements are presented on standards of mixed uranium and plutonium oxide (MOX).

T. A. Kelley, T. E. Sampson, and D. M. DeLapp, "PC/FRAM: Algorithms for the Gamma-Ray Spectrometry Measurement of Plutonium Isotopic Composition," Fifth International Conference

on Facility Operations—Safeguards Interface, September 24–29, 1995 (Full Paper—LA-UR-95-3326).

The Safeguards Program at Los Alamos National Laboratory has developed versatile software for the isotopic analysis of SNM in a sample. The FRAM code has been used routinely at LANL for years. Its capability has now been greatly expanded, and it has been given a graphical user interface. Some of the details on the internal workings of the code are given in this paper.

G. Kuzmycz, C. Bingham, S. Caudill, E. Engling, T. Ewing, A. Hakkila, C. Hine, J. Miranda, Moran, C. Roche, L. Romesberg, R. Rudolph, G. Sheppard, M. Soo Hoo, G. Walters, and T. Zineman, "The U.S. Program of Technical Assistance in Nuclear Safeguards to Ukraine," *Nucl. Mater. Manage.* (Proc. Issue) **XXIV** 131–136 (1995).

Several countries have expressed an interest in providing technical assistance to States of the Former Soviet Union (FSU) to improve their systems for control of nuclear materials. Ukraine has signed agreements with the U.S. concerning development of a national system of control, accounting and physical protection of nuclear materials. U.S. DOE is providing assistance in nuclear material safeguards, including: material control & accountancy (MC&A) systems, measurement techniques, Physical Protection Systems (PPS) and related training. Technical Working Group meetings have been held. Training courses on MC&A, PPS and regulatory procedures are being provided to Ukrainian personnel. Three Ukrainian facilities have been selected for upgrades and a fourth is being discussed with Ukrainian authorities. U.S. teams that included both MC&A and PPS experts visited Ukraine and performed site surveys of the Kiev Institute for Nuclear Research (KINR), the South Ukraine Nuclear Power Plant (SUNPP), and



the Kharkiv Institute of Physics and Technology (KIPT). Areas not conforming with IAEA guidelines were noted and potential upgrades were identified and recommended. Preliminary design packages for upgrades have been completed for KINR and are being prepared for other facilities. Equipment procurement is proceeding and plans are being implemented to install the recommended upgrades. This paper summarizes accomplishments of the program to date, and future plans.

D. G. Langner, M. S. Krick, and K. E. Kroncke, "The Application of Neutron Multiplicity Counting to the Assay of Bulk Plutonium Bearing Materials at RFETS and LLNL," Fifth International Conference on Facility Operations—Safeguards Interface, September 24–29, 1995 (Full Paper—LA-UR-95-3320).

In the past several years, several facilities have identified a need for a large multiplicity counter to support safeguards of excess weapons materials and the measurement control and accountability of large, unusual samples. We have designed and fabricated two large thermal neutron multiplicity counters to meet this need at two DOE facilities. The first of these counters was built for Rocky Flats Environmental Test Site for use in the initial inventory inspection of excess weapons plutonium offered to International Atomic Energy Agency safeguards. The second counter was built for the Lawrence Livermore National Laboratory (LLNL) to support their material control and accountability program. For the LLNL version of the counter, a removable, fast-neutron interrogation assembly was added for the measurement of large uranium samples. In the passive mode these counters can accommodate samples in containers as large as a 30-gal. drum. This paper will report on the measured performance of these two counters and the data obtained with them.

T. K. Li, E. A. Hakkila, S. F. Klosterbuer, H. O. Menlove, P. A. Russo, L. Wangen, H. Ai, I. Kadokura, K. Fujimaki, and M. Koyama, "Evaluation and Development Plan of NRTA Measurement Methods for the Rokkasho Reprocessing Plant," *Nucl. Mater. Manage.* (Proc. Issue) **XXIV** 731–737 (1995).

Near-real-time accounting (NRTA) has been proposed as a safeguards method at the Rokkasho Reprocessing Plant (RRP), a large-scale commercial boiling water and pressurized water reactors spent-fuel reprocessing facility. NRTA for RRP requires material balance closures every month. To develop a more effective and practical NRTA system for RRP, we have evaluated NRTA measurement techniques and systems that might be implemented in both the main process and the co-denitration process areas at RRP to analyze the concentrations of plutonium in solutions and mixed oxide powder. Based on the comparative evaluation, including performance, reliability, design criteria, operation methods, maintenance requirements, and estimated costs for each possible measurement method, recommendations for development were formulated. This paper discusses the evaluations and reports on the recommendation of the NRTA development plan for potential implementation at RRP.

T. K. Li, O. Kitagawa, Y. Kuno, and A. Kurosawa, "Feasibility Study of Plutonium and Uranium Measurements in Input Dissolver Solutions," Fifth International Conference on Facility Operations—Safeguards Interface, September 24–29, 1995; Los Alamos National Laboratory report LA-UR-95-3380.

We are studying the isotope dilution gamma-ray spectrometry (IDGS) technique for the simultaneous measurements of concentrations and isotopic compositions for both plutonium and uranium in spent-fuel dissolver solutions at a reprocessing

plant. Previous experiments have demonstrated that the IDGS technique can determine the elemental concentrations and isotopic compositions of plutonium in dissolver solutions. The chemical separation and recovery methods for just plutonium were ion-exchange techniques using anion-exchange resin beads and filter papers. To keep both plutonium and uranium in the sample for simultaneous measurements, a new sample preparation method is being studied and developed: extraction chromatography. The technique uses U/TEVA•Spec resin to separate fission products and recover both uranium and plutonium in the resin from dissolver solutions for measurements by high-resolution gamma-ray spectrometry.

H. O. Menlove, J. Baca, W. C. Harker, S. Takahashi, S. Terakado, M. Kawashima, K. Maejima, K. Nakagawa, Seki, K. Usui, R. Abedin-Zadeh, and A. Halim, "In-Plant Installation, Performance, Testing, and Calibration for WDAS-1, WDAS-2, and WDAS-3," Los Alamos National Laboratory document LA-UR-95-2966.

This report describes the in-plant installation, performance testing, and calibration for WDAS-1, WDAS-2, and WDAS-3. The original unit, WDAS-1, was installed in November 1991 with subsequent calibration by the IAEA in October 1994. The WDAS-2 and WDAS-3 systems were installed and calibrated in June 1995. The add-a-source calibration function was measured during the original 1991 installation and reverified during the 1994 and 1995 calibrations. All three systems can use the same add-a-source calibration.

Howard O. Menlove, "Passive Neutron Assay of Heterogeneous Waste Drums Using the Segmented Add-a-Source Method," *Nucl. Mater. Manage.* (Proc. Issue) **XXIV** 972-975 (1995).

We have developed passive neutron detectors that include the Add-a-Source (AS) technique to improve the accuracy of the nondestructive assay of plutonium in large waste containers. We have improved the AS by incorporating multiple positions for the  $^{252}\text{Cf}$  source on the exterior of a 200-L drum. The multiple positions give a better coverage of the drum and have the effect of segmenting the matrix as a function of fill height. We have applied the multiposition AS to the assay of drums with heterogeneous matrix combinations of concrete, polyethylene, wood, paper, and metal. The measurement errors caused by the matrix significantly reduced by the AS technique and anomalous shielding material in the drum can be flagged for more detailed investigation.

H. O. Menlove, J. K. Halbig, S. F. Klosterbuer, G. E. Bosler, R. Abedin-Zadeh, and B. Syed-Azmi, "TOKM Hardware Operation Manual," Los Alamos National Laboratory report LA-13008-M (August 1995).

This manual describes the detector design features, performance, and operating characteristics of the Tokai-1 spent fuel monitor. The system includes a pair of monitors—one for the primary (normal) fuel transfer chute and one for the by-pass fuel transfer chute. Each monitor contains four independent detector tubes to provide direction of travel and redundancy. There are two ion chambers and two  $^3\text{He}$  tubes inside each detector package. All of the detectors are used to monitor the presence of spent-fuel gamma rays as the fuel rods pass alongside the detector package. Gamma-ray and neutron detector (GRAND) electronics supply power to the ion chambers

and  $^3\text{He}$  tubes, and the data is collected in the GRAND and the Kontron computer. The system is designed to operate unattended with data pickup by the inspectors on a 90-day period. This manual gives the performance and calibration parameters.

K. Nishida, A. Kurosawa, J. Masui, and S.-T. Hsue, "Intrinsic Densitometry—In-Plant Evaluation," Los Alamos National Laboratory report LA-12878-MS (November 1994).

This report describes the testing of the intrinsic densitometry (ID) technique for in-plant applications. We found that the ID method can determine the plutonium concentrations to between 2 and 3% at concentrations of 100 g/l to 200 g/l with quartz cells and a measurement time of 3600 s. The precision can be improved to 1 to 2% with a higher counting rate. We also found that nitric acid concentration and the impurity level of uranium in the product plutonium solution do not affect the concentration measurement. When this technique is applied to plutonium solutions in stainless steel pipes, we found that similar precision in plutonium concentration can be achieved using a high-count-rate detector. The precision, however, is reduced with aged plutonium solutions.

Chad T. Olinger and Dipen N. Sinha, "Acoustic Techniques in Nuclear Safeguards," presented at the 17th ESAR-DA Annual Symposium on Safeguards and Nuclear Material Management, Aachen, Germany, May 9-11, 1995.

Acoustic techniques can be employed to address many questions relevant to current nuclear technology needs. These include establishing and monitoring intrinsic tags and seals, locating holdup in areas where conventional radiation-based measurements have limited capability, process monitoring, monitoring containers for corrosion or changes in pressure, and facility design verification. These acoustics

applications are in their infancy with respect to safeguards and nuclear material management, but proof-of-principle has been demonstrated in many of the areas listed.

Chad T. Olinger and Dipen Sinha, "Ultrasonic Methods for Locating Hold-Up," presented at the 36th Annual Meeting of the Institute of Nuclear Materials Management, Palm Desert, California, July 9-12, 1995; in *Nucl. Mater. Manage.* **XXIV**, 335-340 (1995).

Hold-up remains one of the major contributing factors to unaccounted for materials and can be a costly problem in decontamination and decommissioning activities. Ultrasonic techniques are being developed to noninvasively monitor hold-up in process equipment where the inner surface of such equipment may be in contact with the hold-up material. These techniques may be useful in improving hold-up measurements as well as optimizing decontamination techniques.

Chad T. Olinger and Susan S. Voss, "A Systems Framework for Nonproliferation Research and Development," presented at the 36th Annual Meeting of the Institute of Nuclear Materials Management, Palm Desert, California, July 9-12, 1995; in *Nucl. Mater. Manage.* **XXIV**, 1094-1099 (1995).

International safeguards and nonproliferation regimes are in a state of rapid flux. Changes in the scope of nonproliferation activities over the next few years will probably bring an overall larger fraction of the world's nuclear material under some form of international inspection. Without a commensurate increase in resources, the unintended net effect could be to reduce the overall effectiveness of international safeguards. One possible solution is to increase fiscal resources, but this may be unrealistic considering the current political climate. Alternatively, technological advances and hard political decisions

can help to increase the effectiveness of nonproliferation resources. This study evaluates the many nonproliferation drivers to determine how to be proactive in a changing political environment.

T. H. Prettyman, S. E. Betts, R. J. Estep, M. C. Lucas, N. J. Nicholas, and R. Harlan, "Demonstration of the Los Alamos Mobile Tomographic Gamma Scanner at the Rocky Flats Environment Technology Site," Los Alamos National Laboratory document LA-UR-95-1861.

On March 24, 1995, a mobile Tomographic Gamma Scanner (TGS) that was developed by Los Alamos to assay radioactive waste arrived at Rocky Flats. During the following week, March 24 through March 31, we moved the trailer to the protected area in the vicinity of Building 776 and assayed a number residue drums. The demonstration this mobile technology, along with the Los Alamos portable real-time radiography (RTR), was sponsored by the Residue Stabilization organization of EG&G Rocky Flats.

T. Prettyman, "Precision Estimates for Tomographic Nondestructive Assay," Fifth International Conference on Facility Operations—Safeguards Interface, September 24–29, 1995 (Full Paper—LA-UR-95-3299).

Precision estimation techniques are developed for the nondestructive assay of special nuclear material by gamma-ray computerized tomography. Contributions from both transmission and emission imaging modes to the variation of the estimated mass of special nuclear material are considered; however, the emission mode is the primary source of statistical variance and is treated in detail. A first-order method to calculate the covariance of the solution of optimization problems with simple positivity constraints is used to estimate the emission mode variance.

The first-order method is tested using replicate trails for a scaled-down version of the emission reconstruction algorithm. A technique to extend this approach to the full-scale emission computerized tomography problem is presented.

P. M. Rinard, S. C. Bourett, and E. L. Adams, "Dounreay NDA5 Shuffler Hardware Manual," Los Alamos National Laboratory document LA-UR-94-3771 (informal distribution).

This hardware manual describes the AEA Technology, Dounreay shuffler for leached hulls and centrifuge bowls (NDA5). The purpose of the instrument is to assay the leached hulls and centrifuge bowls for residual amounts of  $^{239}\text{Pu}$ . The NDA5 instrument applies both passive neutron counting and the active shuffler technique.

P. M. Rinard and C. M. Schneider, "Dounreay NDA5 Shuffler User Manual," Los Alamos National Laboratory document LA-UR-94-3732 (informal distribution).

This hardware manual describes the AEA Technology, Dounreay shuffler for leached hulls and centrifuge bowls (NDA5). The purpose of the instrument is to assay the leached hulls and centrifuge bowls for residual amounts of  $^{239}\text{Pu}$ . The NDA5 instrument applies both passive neutron counting and the active shuffler technique.

Phillip M. Rinard, "Improving Shuffler Assay Accuracy," *Nucl. Mater. Manage.* (Proc. Issue) **XXIV** 367-371 (1995).

The disposal of drums of uranium waste should be disposed of in an economical and environmentally sound manner. The most accurate possible assays of the uranium masses in the drums are required for proper disposal. The accuracies of assays from a shuffler are affected by the type of matrix material in the

drums. Non-hydrogenous matrices have little effect on neutron transport and accuracies are very good. If self-shielding is known to be a minor problem, good accuracies are also obtained with hydrogenous matrices when a polyethylene sleeve is placed around the drums. But for those cases where self-shielding may be a problem, matrices are hydrogenous, and uranium distributions are non-uniform throughout the drums, the accuracies are degraded. They can be greatly improved by determining the distributions of the uranium and then applying correction factors based on the distributions. This paper describes a technique for determining uranium distributions by using the neutron count rates in detector banks around the waste drum and solving a set of overdetermined linear equations. Other approaches were studied to determine the distributions and are described briefly. Implementation of this correction is anticipated on an existing shuffler next year.

P. M. Rinard, "Measuring the Fill Height of Sealed Cans with a Compound Pendulum," Los Alamos National Laboratory report LA-12964-MS (June 1995).

A compound pendulum has been designed, fabricated, tested, and used to determine the fill height of material in sealed cans. The specific cans that stimulated this work are partially filled with uranium and plutonium oxide. Fill height affects nondestructive assays using fission neutrons, but corrections for various fill heights can be made once the height is known. Heights vary with use as the powder compacts or loosens, so it is necessary to determine the height at the time of the neutron measurement. The pendulum is small and readily portable so it can be taken to the location of the neutron measurement. Tests with open cans filled with sand to various known

heights had accuracies generally within 3%. Factors that can affect the accuracy are examined and discussed. Experience in using the pendulum on sealed cans is related.

C. A. Rodriguez, J. A. Howell, H. O. Menlove, C. M. Brislawn, J. N. Bradley, P. Chare, and J. Gorten, "Video Image Processing for Nuclear Safeguards," presented at the Carnahan Conference on Security Technology, Surrey, England, October 11, 1995; Los Alamos National Laboratory document LA-UR-95-2510 (1995).

The field of nuclear safeguards has received increasing amounts of public attention since the events of the Iraq-UN conflict over Kuwait, the dismantlement of the former Soviet Union and, more recently, the North Korean resistance to nuclear facility inspections by the International Atomic Energy Agency (IAEA). The role of nuclear safeguards in these and other events relating to the world's nuclear material inventory is to assure safekeeping of these materials and to verify the inventory and use of nuclear materials as reported by states that have signed the nuclear Nonproliferation Treaty throughout the world. Nuclear safeguards are measures prescribed by domestic and international regulatory bodies such as DOE, NRC, IAEA, and EURATOM and implemented by the nuclear facility or the regulatory body. These measures include destructive and nondestructive analysis of product materials/process by-products for materials control and accountability purposes, physical protection for domestic safeguards, and containment and surveillance for international safeguards.

An example of materials analysis may be the destructive analysis of a sample to verify reported enrichment levels, or the nondestructive gamma-ray measurements of materials in storage for quantitative verification. Materials control and accountability

entails tracking materials through processing, fuel cycles, and reprocessing by implementing procedures and maintaining databases through the material's life cycle. These procedures may include the establishment of "boundaries" within a facility that serve as accountability points. Inventory balances are then maintained in the databases and can be analyzed at discrete intervals for inventory differences that may indicate theft or diversion of nuclear materials.

Physical protection measures are used in domestic safeguards and include deterrents that protect materials from theft or tampering. They may include guards, video, fences, and concrete barriers for facility protection. Containment and surveillance is used widely in international safeguards and may include paper, metal, or fiber optic seals for item monitoring; radiation detection devices; live video monitoring of facility areas; and recording of facility activities for later review. Recently this recording has been done by intelligent systems capable of unattended monitoring and scene analysis with triggered video recording that provides personnel with specific information about safeguards-related events.

In this presentation we will introduce digital video image processing and analysis systems that are being developed at Los Alamos for application to nuclear safeguards. Of specific interest to this audience will be the Inventory Verification System (IVSystem), an automated materials monitoring system; the Video Time Radiation Analysis Program (VTRAP), an integrated safeguards system; VideoTech, a surveillance system designed in conjunction with EURATOM for use in international safeguards; and we will introduce detector-activated predictive wavelet transform image coding used to significantly reduce the

image data storage requirements for all of these unattended, remote safeguards systems.

P. A. Russo, H. A. Smith, J. K. Sprinkle, Jr., C. W. Bjork, G. A. Sheppard, and S. E. Smith, "Evaluation of an Integrated Holdup Measurement System Using the GGH Formalism with the M<sup>3</sup>CA," Fifth International Conference on Facility Operations—Safeguards Interface, September 24–29, 1995 (Full Paper—LA-UR-95-3321).

Nuclear facilities need portable, automated tools based on gamma-ray spectroscopy to perform plantwide assays of special nuclear materials (SNM) deposited as holdup in processing equipment. These assays satisfy such nuclear material control functions as obtaining or verifying SNM inventory quantities, assuring safe operating conditions, and quantifying SNM for decontamination and decommissioning. A new, integrated holdup measurement system designed to meet these requirements has been evaluated quantitatively for holdup assays.

The hardware for the integrated holdup measurement system consists of a compact gamma-ray detector with collimation and shielding, a self-contained portable gamma-ray spectroscopy instrument, and a palm-size programmable control and data-storage unit. The application software, called HMSII (Holdup Measurement System II), masks the sophistication of the hardware and data analysis with a simple user interface. The heart of the integrated holdup measurement system is the generalized-geometry holdup (GGH) calibration and analysis formalism. The GGH formalism is based on the simplifying assumptions that each of hundreds of holdup deposit geometries in the facility can be interpreted as one of three simple geometric models (point, line, or area) to reduce the calibration and analysis effort to manageable proportions.

Results with the integrated holdup measurement system have been obtained over a 4-year period. Because of the reproducibility of setup and data treatment under HMSII automation, it is straightforward to repeat the assays of static equipment over extended periods of time with multiple users. This new integrated measurement system improves the precision and reliability of holdup measurements.

P. A. Russo, Q. D. Appert, M. M. Martinez, M. H. West, T. A. Kelley, and R. S. Biddle, "Quantitative Monitoring of the Plutonium Fluorination Process by Neutron Counting," Los Alamos National Laboratory report LA-12802-MS (February 1995). (Limited Access; not for public dissemination)

Plutonium metal is produced by reduction of  $\text{PuF}_4$  prepared from  $\text{PuO}_2$  by fluorination. Both fluorination and reduction are batch processes at the Los Alamos Plutonium Facility. The conversion of plutonium oxide to fluoride is accompanied by a large increase in neutron production, a result of the high alpha-neutron ( $\alpha, n$ ) yield on fluorine targets compared to the (more than 100 times) smaller yield on oxygen targets. Because of this large change in neutron yield, total neutron counting can be used to monitor the conversion process. This monitoring ability can lead to an improved metal product, less scrap for recycling, minimum waste, minimized reagent usage, and reduced personnel radiation exposures. A new stirred-bed fluorination process has been developed simultaneously with a recent evaluation of an automated neutron counting instrument for quantitative process monitoring. Neutrons were counted using polyethylene-moderated  $^3\text{He}$ -gas proportional counters. The real-time neutron-count-rate indicator for the quantitative extent of fluorination has been calibrated using reference values obtained from the destructive

analysis of samples from the blended fluorinated batch. One of three reference techniques has been determined most suitable for calibration of the continuous neutron monitor (CNM) as well as for long-term verification of the calibration during on-line operation. The use of the CNM on the fluorination process demonstrates the benefits of both an improved product and minimized plutonium in the waste stream of the metal preparation line. We discuss the use of the monitor for sensitive experimental studies of the mechanism and kinetics of the fluorination.

Debra A. Rutherford, Jack T. Markin, Bryan Fearey, Calvin Jaeger, Ron W. Moya, Ruth A. Duggan, Deith M. Tolk, John C. Matter, Scott Strait, and Lonnie R. Moore, "Proliferation Resistance Criteria for Disposition of Fissile Materials," presented at the 36th Annual Meeting of the Institute of Nuclear Materials Management, Palm Desert, California, July 9–12, 1995; in *Nucl. Mater. Manage.* XXIV, 400–406 (1995).

The 1994 National Academy of Sciences study "Management and Disposition of Excess Weapons Plutonium" defined options for reducing the national and international proliferation risks of materials declared excess to the nuclear weapons program. This paper proposes criteria for assessing the proliferation resistance of these options as well as defining the "Standards" from the report. The criteria are general, encompassing all stages of the disposition process from storage through intermediate processing to final disposition including the facilities, processing technologies and materials, the level of safeguards for these materials, and the national/sub-national threat to the materials.

T. E. Sampson, T. A. Kelley, T. L. Creemers, T. R. Konkel, and R. J. Friar, "PC/FRAM: New Capabilities for the Gamma-Ray Spectrometry Measurement of Plutonium Isotopic Composition," Fifth International Conference on Facility Operations—Safeguards Interface, September 24–29, 1995 (Full Paper—LA-UR-95-3287).

We describe the new capability of and present measurement results from the PC/FRAM plutonium isotopic analysis code. This new code allows data acquisition from a single coaxial germanium detector and analysis over an energy range from 120 keV to above 1 MeV. For the first time we demonstrate a complete isotopic analysis using only gamma rays greater than 200 keV in energy. This new capability allows the measurement of the plutonium isotopic composition of items inside shielded or heavy-walled containers without having to remove the items from the container. This greatly enhances worker safety by reducing handling and the resultant radiation exposure. Another application allows international inspectors to verify the contents of items inside sealed, long-term storage containers that may not be opened for national security or treaty compliance reasons. We present measurement results for traditional planar germanium detectors as well as coaxial detectors measuring shielded and unshielded samples.

William D. Stanbro, Richard Libby, and Joshua Segal, "Studies in Support of an SNM Cutoff Agreement: The PUREX Exercise," presented at the 36th Annual Meeting of the Institute of Nuclear Materials Management, Palm Desert, California, July 9–12, 1995; published in *Nucl. Mater. Manage.* XXIV, 1056–1062 (1995).

On September 23, 1993, President Clinton, in a speech before the United Nations General Assembly, called

for an international agreement banning the production of plutonium and highly enriched uranium for nuclear explosive purposes. A major element of any verification regime for such an agreement would probably involve inspections of reprocessing plants in Nuclear Nonproliferation Treaty weapons states. Many of these are large facilities built in the 1950s with no thought that they would be subject to international inspection. To learn about some of the problems that might be involved in the inspection of such large, old facilities, the Department of Energy, Office of Arms Control and Nonproliferation, sponsored a mock inspection exercise at the PUREX plant on the Hanford Site. This exercise examined a series of alternatives for inspections of the PUREX as a model for this type of facility at other locations. A series of conclusions were developed that can be used to guide the development of verification regimes for a cutoff agreement at reprocessing facilities.

J. E. Stewart, M. S. Krick, D. G. Langner, T. D. Reilly, W. Theis, R. J. Lemaire, and J. Xiao, "Implementation of Neutron Counting Techniques at U.S. Facilities for IAEA Verification of Excess Materials from Nuclear Weapons Production," *Nucl. Mater. Manage.* (Proc. Issue) XXIV 548-554 (1995).

The U.S. Nonproliferation and Export Control Policy, announced by President Clinton before the United Nations General Assembly on September 27, 1993, commits the U.S. to placing under International Atomic Energy Agency (IAEA) Safeguards excess nuclear materials no longer needed for the U.S. nuclear deterrent. As of July 1, 1995, the IAEA had completed Initial Physical Inventory Verification (IPIV) at two facilities: a storage vault in the Oak Ridge Y-12 plant containing highly enriched uranium (HEU) metal and another storage

vault in the Hanford Plutonium Finishing Plant (PFP) containing plutonium oxide and plutonium-bearing residues. Another plutonium-storage vault, located at Rocky Flats, is scheduled for the IPIV in the fall of 1995. Conventional neutron coincidence counting is one of the routinely applied IAEA nondestructive assay (NDA) methods for verification of uranium and plutonium. However, at all three facilities mentioned above, neutron NDA equipment had to be modified or developed for specific facility needs such as the type and configuration of material placed under safeguards. At Y-12, the size and uranium mass of items to be verified required modification of the Active Well Coincidence Counter (AWCC).<sup>1,2</sup> The facility prepared a set of calibration standards representative of the items to be measured. The IAEA certified these standards by destructive analysis (DA). Compared with operator declarations for <sup>235</sup>U mass (weighing and isotopic analysis), the IAEA AWCC measurement values agreed to within 0.5% for randomly selected items. At Hanford, the IAEA used the standard High-Level Neutron Coincidence Counter (HLNC)<sup>3</sup> for verification of pure PuO<sub>2</sub>. For verification of plutonium material containing unknown impurity concentrations, the IAEA used a 3-Ring Multiplicity Counter (3RMC) provided by LANL. The 3RMC gave better results for the impure material than could have been achieved using the HLNC. Also, the 3RMC showed an improvement in measurement performance for pure PuO<sub>2</sub> because of higher efficiency than the HLNC. At Rocky Flats, a new neutron multiplicity counter designed for multiple-can plutonium oxide containers will be used for the IPIV. This will enable measurement of multiple-can items and thereby reduce radiation exposure to plant personnel as well as inspectors. Also, this counter is

expected to be used for facility as well as the IAEA's verification purposes for a variety of nuclear materials present at this facility.

T. Thomas, R. Strittmatter, M. Nichols, and C. McEvilly, "1994 INMM Annual Meeting Proceedings Placed On-Line," *Nucl. Mater. Manage.* XXIV(1), 9-10 (Fall 1995).

No abstract.

G. Tittmore, G. Kuzmycz, E. A. Hakkila, T. D. Reilly, J. K. Sprinkle, Jr., M. Barnham, T. Gafford, A. Eras, Snell, S. Caudill, W. Mitchell, P. Freed, Roche, P. Henslee, and R. Burnham, The U.S. Program of Technical Assistance to the Atomic Energy Agency of the Republic of Kazakstan, *Nucl. Mater. Manage.* (Proc. Issue) XXIV 126-130 (1995).

In the summer of 1993, the U.S. Government received a formal invitation from the Atomic Energy Agency of the Republic of Kazakstan (AEARK) to visit Kazakstan to prepare a program for U.S. cooperation with the AEARK to improve material protection, control, and accounting (MPCA) at Kazakstani nuclear facilities. As a result of this visit, an agreement for such cooperation was prepared and a program plan was formulated. The Program Plan includes provisions for Technical Working Group meetings, a site survey of a Kazakstani nuclear facility for possible upgrades in MPCA, assistance to AEARK in the regulatory area, training courses to familiarize AEARK and nuclear facility personnel with U.S. safeguards practices, and supply of U.S. safeguards equipment. This cooperative program is funded by the Nunn-Lugar program and the Department of Energy. The program is coordinated with the International Atomic Energy Agency and similar programs of other donor countries (Sweden, Japan, and the United Kingdom).

This paper summarizes accomplishments of the program to date and future plans.

Lawrence Wangen, "IAEA Reprocessing Plant Safeguards," Los Alamos National Laboratory, Safeguards Systems Group report NIS-7/95-802 (July 1995).

No abstract.

T. L. Welsh, L. P. McRae, C. H. Dele-gard, A. M. Liebetrau, W. C. Johnson, M. S. Krick, J. E. Stewart, W. Theis, J. Lemaire, and J. Xiao, "Comparison of NDA and DA Measurement Techniques for Excess Pu Powders at the Hanford Site: Operator and IAEA Experience," *Nucl. Mater. Manage.* (Proc. Issue) **XXIV** 539-544 (1995).

Quantitative physical measurements are necessary components of the International Atomic Energy Agency (IAEA) nuclear material safeguards verification regime. In December 1994, IAEA safeguards were initiated on an inventory of plutonium-bearing oxide and scrap items in Vault 3 of the 2736-Z Building of the Plutonium Finishing Plant on the United States Department of Energy's (USDOE) Hanford Site. The material originated in the United States nuclear weapons complex. The diversity of the chemical form and the heterogenous physical form of the plutonium in this inventory were expected to challenge the target precision and accuracy of methods employed by IAEA: quantitative destructive analytical techniques (which are susceptible to sampling error) and quantitative coincident neutron measurements (which rely on knowledge of the material's chemical form and purity). Because of the diverse and heterogenous nature of plutonium-bearing scrap, plant operations increasingly have adopted calorimetric techniques both for item inventory measurements and for verification purposes. During the recent advent

of IAEA safeguards at Vault 3, a set of destructive and non-destructive methods were applied to a number of inventory items (cans of plutonium-bearing powders) with widely ranging chemical purities. Results of these measurements, gathered by the operator's and IAEA's laboratories and instruments as well as by instruments from Pacific Northwest Laboratory and USDOE's Los Alamos National Laboratory (LANL), are presented and statistically compared.

T. R. Wenz, H. O. Menlove, G. Walton, and J. Baca, "Design and Calibration of the AWCC for Measuring Uranium Hexafluoride," Los Alamos National Laboratory report LA-12992 (August 1995).

An Active Well Coincidence Counter (AWCC) has been modified to measure variable enrichment uranium hexafluoride ( $UF_6$ ) in storage bottles. An active assay technique was used to measure the  $^{235}U$  content because of the small quantity (nominal loading of 2 kg  $UF_6$ ) and nonuniform distribution of  $UF_6$  in the storage bottles. A new insert was designed for the AWCC composed of graphite containing four americium-lithium sources. Monte Carlo calculations were used to design the insert and to calibrate the detector. Benchmark measurements and calculations were performed using uranium oxide samples. The Monte Carlo generated calibration curves benchmarked to uranium oxide resulted in assay values that agreed within 2 to 3% of destructive assay values. In addition to  $UF_6$ , the detector was also calibrated for HEU ingots, billets, and alloy scrap using the standard Mode 1 end-plug configuration.

T. R. Wenz, "A Transport Based One-Dimensional Perturbation Code for Reactivity Calculations in Metal Systems," Los Alamos National Laboratory report LA-12888-T (February 1995).

A one-dimensional reactivity calculation code is developed using first order perturbation theory. The reactivity equation is based on the multi-group transport equation using the discrete ordinates method for angular dependence. In addition to the first order perturbation approximations, the reactivity code uses only the isotropic scattering data, but cross section libraries with higher order scattering data can still be used with this code. The reactivity code obtains all the flux, cross section, and geometry data from the standard interface files created by ONEDANT, a discrete ordinates transport code.

Comparisons between calculated and experimental reactivities were done with the central reactivity worth data for Lady Godiva, a bare uranium metal assembly. Good agreement is found for isotopes that do not violate the assumptions in the first order approximation. In general for cases where there are large discrepancies, the discretized cross section data is not accurately representing certain resonance regions that coincide with dominant flux groups in the Godiva assembly. Comparing reactivities calculated with first order perturbation theory and a straight  $\Delta k/k$  calculation shows agreement within 10% indicating the perturbation of the calculated fluxes is small enough for first order perturbation theory to be applicable in the modeled system. Computation time comparisons between reactivities calculated with first order perturbation theory and straight  $\Delta k/k$  calculations indicate considerable time can be saved performing a calculation with a perturbation code particularly as the complexity of the modeled problems increase.

Rena Whiteson, Lisa Spanks, Tresa Yarbrow, H. Ferman Kelso, Janet Zirkle, and Chris Baumgart, "Anomaly Detection Applied to a Materials Control and Accounting Database," presented at the 36th Annual Meeting of the Institute of Nuclear Materials Management, Palm Desert, California, July 9-12, 1995; published in *Nucl. Mater. Manage.* **XXIV**, 1256-1261 (1995).

An important component of the national mission of reducing the nuclear danger includes accurate recording of the processing and transportation of nuclear materials. Nuclear material storage facilities, nuclear chemical processing plants, and nuclear fuel fabrication facilities collect and store large amounts of data describing transactions that involve nuclear materials. To maintain confidence in the integrity of these data, it is essential to identify anomalies in the databases. Anomalous data could indicate error, theft, or diversion of material. Yet, because of the complex and diverse nature of the data, analysis and evaluation are extremely tedious.

This paper describes our work in the development of analysis tools to automate the anomaly detection process for the Material Accountability and Safeguards System (MASS) that tracks and records the activities associated with accountable quantities of nuclear material at Los Alamos National Laboratory. Using existing guidelines that describe valid transactions, we have created an expert system that identifies transactions that do not conform to the guidelines. Thus, this expert system can be used to focus the attention of the expert or inspector directly on significant phenomena.

Rena Whiteson and Chris Baumgart, "Results of Test of Facility Specific Anomaly Detector," annual report submitted to DOE/OSS, Los Alamos National Laboratory document LA-UR-95-3491 (October 1995).

No abstract.

William J. Whitty, Jennifer E. Smith, and James E. Davis, Jr., "Los Alamos' MAWST Software Layered on Westinghouse Savannah River Company's Nuclear Material Accountability System," presented at the 36th Annual Meeting of the Institute of Nuclear Materials Management, Palm Desert, California, July 9-12, 1995; in *Nucl. Mater. Manage.* **XXIV**, 1268-1273 (1995).

The Los Alamos Safeguards Systems Group's Materials Accounting With Sequential Testing (MAWST) computer program was developed to fulfill DOE Order 5633.3B requiring that inventory-difference control limits be based on variance propagation or any other statistically valid technique. Westinghouse Savannah River Company (WSRC) developed a generic computerized accountability system, NucMAS, to satisfy accounting and reporting requirements for material balance areas. NucMAS maintains the calculation methods and the measurement information required to compute nuclear material transactions in elemental and isotopic masses by material type code. The Safeguards Systems Group designed and implemented to WSRC's specifications a software interface application, called NucMASloe. It is a layered product for NucMAS that automatically formats a NucMAS data set to a format compatible with MAWST and runs MAWST. This paper traces the development of NucMASloe from the Software Requirements through the testing and demonstration stages. The general design constraints are described as well as the difficulties

encountered on inter-facing an external software product (MAWST) with an existing classical accounting structure (NucMAS). The design and the lessons learned from this effort are directly applicable to the Local Area Network Material Accountability System (LANMAS) being sponsored by DOE.

D. D. Wilkey and W. J. Whitty, "Development of a Near-Real-Time Accountability System for Fuel Fabrication Facilities," presented at the 5th International Conference on Facility Operations—Safeguards Interface, Jackson Hole, Wyoming, September 24-29, 1995.

This paper discusses design issues for establishing a near-real-time accountability (NRTA) system for modern fuel fabrication facilities; however, the approach for developing an NRTA could be applied to many nuclear facilities planned for construction.

The proposed design is for a computerized materials accounting system capable of providing near-real-time material balances and associated variances. The system must accommodate data from both destructive analysis (DA) and non-destructive analyses (NDA) of material in process and in interim storage. DA and mass measurements are used by facility operations for process control and to draw material balances. NDA measurements will be used primarily by International Atomic Energy Agency inspectors to verify inventories.

An essential component of the NRTA system is a software interface between the facility's process control computer and the NRTA computer. The interface facilitates the use of process measurement and material transfer data to compute materials unaccounted for (MUF), limit of error of MUF (LEMUF), and covariance matrices for a sequence of



MUFs. The design of the interface facilitates use of the LANL-developed software Materials Accounting with Sequential Testing for the NRTA calculations described above.

The basic approach involves a comprehensive systems analysis to evaluate the NRTA system design; development of simulation software for the analysis of process flows, holdup, and MUF/LEMUF; development of evaluation software for analysis of NRTA systems; and preparation of design specifications for software to implement NRTA.

Development and application of a model of the process and measurement systems will allow evaluation of operating parameters (material flows, holdup, and effects of changes in throughput) as well as safeguards parameters (MUF and LEMUF). There are two possible approaches to developing a simulation model of the process: (1) simulate the measurement system, and (2) simulate the process and the measurement system. Simulation of the measurement system would concentrate on statistical functions of measurements in sequences of material balances, such as the propagation of variance. Simulation of the process and the measurement system would add process variability to the former approach, providing more data and allowing various scenarios to be analyzed for their impact on safeguards and plant operations.

Because the NRTA data may be used by international inspectors, we will also consider evaluating the inspector's attributes measurement plan and the variable measurement plan associated with the MUF-d statistic. The Los Alamos Inspection Optimization by Dynamic Programming (IODYN) computer program can be applied to develop plans that are either optimal for detection probability or for cost to the operator.

D. D. Wilkey, "Development of an ASTM Standard Guide on Performing Vulnerability Assessments for Nuclear Facilities," presented at the 36th Annual Meeting of the Institute of Nuclear Materials Management, Palm Desert, California, July 9–12, 1995; published in *Nucl. Mater. Manage.* **XXIV**, 944–947 (1995).

This paper describes an effort undertaken by subcommittee C26.12 (Safeguards) of the American Society for Testing and Materials (ASTM) to develop a standard guide for performing vulnerability assessments (VAs). VAs are performed to determine the effectiveness of safeguards and security systems for both domestic and international nuclear facilities. These assessments address a range of threats, including theft of nuclear material and sabotage, and use an array of methods. The approach to performing and documenting VAs is varied and is largely dependent upon the tools used to perform them. This diversity can lead to tools being misused, making validation of VAs more difficult. The development of a standard guide for performing VAs would, if generally accepted, alleviate these concerns. ASTM provides a forum for developing guides that includes a high level of peer review to assure that the result is acceptable to all potential users. Additionally, the ASTM is widely recognized for setting standards, and endorsement by the Society may increase the likelihood of acceptance by the nuclear community. The goal of this work is to develop a guide that is independent of the tools being used to perform the VA and applicable to the spectrum of threats described above.

R. L. York, P. E. Fehlau, and D. A. Close, "Exporting Automatic Vehicle SNM Monitoring Technology," presented at the 5th International Conference on Facility Operations/Safeguards Interface in Jackson Hole, Wyoming, September 25–29, 1995. Los Alamos

National Laboratory publication LA-UR-95-3301.

N. R. Zack and E. J. Kirk, "Weapons Dismantlement Issues in Independent Ukraine," *Nucl. Mater. Manage.* **XXIII**(2), 18–22 (February 1995).

The American Association for the Advancement of Science sponsored a seminar during September 1993, in Kiev, Ukraine, entitled "Toward a Nuclear Free Future—Barriers and Problems." It brought together Ukrainians, Belarusians, and Americans to discuss the legal, political, safeguards and security, economic, and technical dimensions of nuclear weapons dismantlement and destruction. U.S. representatives initiated discussions on legal and treaty requirements and constraints, safeguards and security issues surrounding dismantlement, storage and disposition of nuclear materials, warhead transportation, and economic considerations. Ukrainians gave presentations on arguments for and against the Ukraine keeping nuclear weapons, Ukrainian Parliament non-approval of START I, alternative strategies for dismantling silos and launchers, and economic and security implications of nuclear weapons removal from the Ukraine. Participants from Belarus discussed proliferation and control regime issues. This paper will highlight and detail the issues, concerns, and possible impacts of the Ukraine's dismantlement of its nuclear weapons.

N. R. Zack and D. W. Crawford, "International Inspection Activity Impacts upon DOE Safeguards Requirements," presented at the 36th Annual Meeting of the Institute of Nuclear Materials Management, Palm Desert, California, July 9–12, 1995; published in *Nucl. Mater. Manage.* **XXIV**, 516–520 (1995).

The United States has placed certain special nuclear materials declared excess to our strategic needs under international safeguards through the

International Atomic Energy Agency (IAEA). This Presidential initiative has obligated materials at several Department of Energy (DOE) facilities for these safeguards activities to demonstrate the willingness of the U.S. to ban production or use of nuclear materials outside of international safeguards. However, IAEA inspection activities generally tend to be intrusive in nature and are not consistent with several domestic safeguards procedures implemented to reduce worker radiation exposures and increase the cost-effectiveness and efficiency of accounting for and storing of special nuclear materials. To help identify and provide workable solutions to these concerns, the Office of Safeguards and Security has conducted a program to determine possible changes to the DOE safeguards and security requirements designed to help facilities under international safeguards inspections more easily comply with domestic safeguards goals during international inspection activities. This paper will discuss the impact of international inspection activities on facility safeguards operations and departmental safeguards procedures and policies.

Andrew Zardecki and Richard B. Strittmatter, "Chemical and Isotopic Determination from Complex Spectra," presented at the 36th Annual Meeting of the Institute of Nuclear Materials Management, Palm Desert, California, July 9-12, 1995; published in *Nucl. Mater. Manage.* **XXIV**, 817-822 (1995).

Challenges for proliferation detection include remote, high-sensitivity detection of chemical effluents from suspect facilities and enhanced detection sensitivity for nuclear

material. Both the identification of chemical effluents with lidar and enhanced nuclear material detection from radiation sensors involve determining constituents from complex spectra. In this paper, we extend techniques used to analyze time series to the analysis of spectral data. Pattern identification methods are applied to spectral data for domains where standard matrix inversion may not be suitable because of detection statistics. We use a feed-forward, back-propagation neural network in which the nodes of the input layer are fed with the observed spectral data. The nodes of the output layer contain the identification and concentration of the isotope or chemical effluent the sensor is to identify. We will discuss the neural network architecture, together with preliminary results obtained from the training process.

Andrew Zardecki, "Rule-Based Pattern Recognition," presented at the Third Annual International Conference on Fuzzy-Neural Applications, Systems and Tools, San Francisco, November 7-9, 1995.

Fuzzy logic controller and related techniques, chiefly fuzzy basis functions expansion, are applied to time series forecasting and anomaly detection in temporal and spatial patterns. The usefulness of different techniques is compared using the simple parity classification problem as an example. Forecasting of a time series is analyzed, together with a brief discussion of chaotic and noisy patterns. As a by-product of the rule-based forecasting, an edge detection algorithm for digital images is obtained.

Andrew Zardecki, "Automated Anomaly Detection," annual report submitted to DOE/OSS, Los Alamos National Laboratory document LA-UR-95-3476 (October 1995).

The purpose of the anomaly detection project is to develop, test, and implement a methodology to automate real-time data analysis of special nuclear material (SNM) in process and in storage. The computer program that accomplishes this objective is based on a library of rules generated from the available trends in the SNM accounting; future trends are then identified by comparing the data with the existing rules, augmented by statistical fluctuations. Once developed and tested, the program is intended to serve the needs of all DOE sites that use nuclear material accounting in any form. Potential payoffs include reduction in time and resources needed to perform statistical tests and broad applicability to DOE needs, e.g., treaty verification.